

# Pools



2019

[www.gre.es](http://www.gre.es)







Pools



# índice index sommaire indice

INTRODUCCIÓN INTRODUCTION INTRODUCTION INTRODUZIONE		Pag. <b>04</b>
PISCINAS ENTERRADAS IN-GROUND POOLS PISCINE ENTERRÉE PISCINE INTERRATA		Pag. <b>08</b>
PISCINAS DE MADERA WOODEN POOL PISCINE BOIS PISCINA IN LEGNO		Pag. <b>16</b>
PISCINAS DE COMPOSITE COMPOSITE POOLS PISCINES COMPOSITE PISCINA IN COMPOSITE		Pag. <b>34</b>
PISCINAS HIBRIDAS HYBRIDS POOLS PISCINES HYBRIDE PISCINE IBRIDE		Pag. <b>40</b>
PISCINAS DE ACERO STEEL WALL POOLS PISCINES PAROI ACIER PISCINA IN ACCIAIO		Pag. <b>44</b>
COMPLEMENTOS COMPLEMENTS COMPLEMENTES COMPLEMENTI		Pag. <b>78</b>
MATERIAL DE LIMPIEZA CLEANING MATERIAL MATÉRIEL DE NETTOYAGE MATERIALE DI PULIZIA		Pag. <b>130</b>
PRODUCTO QUÍMICO CHEMICALS PRODUITS D'ENTRETIEN CHIMICI		Pag. <b>164</b>

**PISCINAS POOLS PISCINES PISCINAS**  
COMPOSITE



**MADERA WOODEN BOIS LEGNO**



**GAMA GRAPHITE GRAPHITE RANGE**  
GAMME GRAPHITE GAMMA GRAPHITE



**RECOGEHOJAS**  
LEAF RAKE  
ÉPUISETTE DE FOND  
RACCOGLITORE DI FONDO

**LIMPIAFONDOS ELÉCTRICOS**  
ELECTRIC CLEANERS  
NETTOYEUR DE FOND ÉLECTRIQUE  
PULITORE ELETTRICO PER FONDO PISCINA

**PREFILTRO**  
PREFILTER  
PREFILTRE  
PREFILTRO

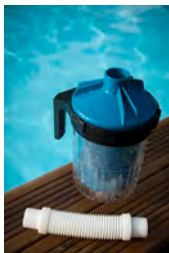

**ELECTRÓLISIS DE SAL**  
SALT CHLORINATOR  
ELECTROLYSE AU SEL  
ELETTROLISI SALINA



**FILTRO AQUALOON**  
AQUALOON FILTER  
AQUALOON FILTRE  
AQUALOON FILTRO



**PROYECTOR**  
PROJECTOR  
PROJECTEUR  
PROIETTORE



**blueconnect**



**PRODUCTO QUÍMICO**  
CHEMICALS  
PRODUITS D'ENTRETIEN  
CHIMICI



**DUCHA**  
SHOWER  
DOUCHE  
DOCCIA



**BOMBAS DE CALOR MINI**  
MINI HEAT PUMPS  
POMPES DE CHALEUR MINI  
POMPA DI CALORE MINI





## Presentación de la empresa

Gre es una empresa con más de 50 años de experiencia en la fabricación de piscinas elevadas.

Como empresa pionera en el sector, somos especialistas y líderes a nivel europeo.

Nuestra apuesta clara por la calidad y seguridad de todos nuestros productos, nos convierte en la referencia fundamental del mercado.

Nuestra empresa ofrece una amplia gama de productos: piscinas elevadas de diferentes formatos y acabados, una completa línea de accesorios para su equipamiento y mantenimiento y una serie de productos químicos diseñados específicamente para el agua de la piscina.

Con el ánimo siempre, de satisfacer al cliente, Gre ha diseñado una estrategia de servicios, cuyo objetivo es ofrecer una solución integral. Nuestra amplia red de Servicios Técnicos, así como nuestros Departamentos de Atención al Cliente, son la mejor prueba de ello. Estos servicios nos permiten asesorarle sobre la opción de piscina y equipamiento más adecuados a sus necesidades.

## Présentation de l'entreprise

Gré est une société spécialisée dans la fabrication de piscines hors-sol.

Pionnière dans le secteur, notre entreprise est SPÉCIALISTE et LEADER en EUROPE.

Notre pari sur la QUALITÉ et la SÉCURITÉ de tous nos produits nous permet d'être la principale RÉFÉRENCE du marché.

Notre entreprise offre une LARGE GAMME de produits, allant des piscines hors-sol aux tailles et finitions diverses et variées, jusqu'à un éventail complet des accessoires nécessaires à l'équipement et à l'entretien, et une gamme de produits chimiques conçus spécifiquement pour l'eau de la piscine.

Toujours dans le but de satisfaire le client, Gre a conçu une stratégie de SERVICES dont l'objectif est d'offrir une réponse et une solution complètes: un important réseau de Services Techniques ainsi qu'un Service Clients. Ces services nous permettent de vous conseiller sur le choix tant de votre piscine que de l'équipement le plus approprié à vos besoins.

## Company presentation

Gre is a company with more than 50 years experience in manufacturing above-ground pools.

As a pioneer company on its field, we are SPECIALISTS and LEADERS within the European market.

We are considered to be a fundamental market REFERENCE as a result of our clear wager on QUALITY and SECURITY of all our products.

Our company offers a WIDE RANGE of products which includes: different sizes and finishes aboveground pools, a complete range of accessories for their equipment and maintenance and a number of swimming pool chemicals designed specifically for the pool water.

Bearing in mind our customers satisfaction, Gre has designed an important SERVICES strategy whose aim is to offer an integral solution. Our wide network of Technical Services and our Customer Service Departments are the best proof of that. These services help us to identify our customers needs and to advice them on the best pool and equipment according to those needs.

## Presentazione dell'azienda

La Gre è un'azienda con oltre 50 anni di esperienza nella produzione di piscine smontabili su terra.

Come impresa pioniera nel settore, siamo SPECIALISTI e LEADER a livello EUROPEO.

La nostra chiara scommessa sulla QUALITÀ e sulla SICUREZZA di tutti i nostri prodotti, fa di noi il RIFERIMENTO fondamentale del mercato.

La nostra società offre una VASTA GAMMA di prodotti: piscine elevate di diversi formati e rifiniture, una completa linea di accessori per l'attrezzatura e la manutenzione e una serie di prodotti chimici pensati specificamente per l'acqua della piscina.

Sempre con l'intenzione di soddisfare il cliente, la Gre ha progettato una strategia di SERVIZI il cui scopo è quello di offrire una soluzione integrale. La nostra vasta rete di Servizi Tecnici, così come i nostri Reparti di Servizio al Cliente, ne sono la miglior prova. Tali servizi ci consentono di dare consulenza sulla scelta della piscina e dell'equipaggiamento più idoneo alle vostre necessità.

# Certificaciones Certifications Certifications Certificazioni

## MADE IN EUROPE

Todas las piscinas fabricadas por manufacturas GRE S.A. Son de origen CE - Comunidad Europea.

Toutes les piscines fabriquées par Manufacturas Gre S.A. sont d'Origine CE - Communauté Européenne.

All the pools manufactured by Manufacturas Gre S.A. are of EC - European Community origin.

Tutte le piscine prodotte da Manufacturas Gre S.A. sono di origine CE - Comunità Europea.



## ISO 9001

Los procesos utilizados para el diseño, la fabricación y comercialización de piscinas desmontables de Manufacturas Gre S.A., así como la comercialización de productos asociados, están certificados siguiendo los criterios de sistema de Gestión de Calidad según la norma internacional ISO9001:2015, lo cual garantiza regularidad y control en la calidad de nuestros productos y procesos.

Les processus utilisés pour la conception, la fabrication et la commercialisation de piscines hors-sol de Manufacturas Gre S.A., ainsi que la commercialisation de produits associés, sont certifiés conformes aux critères de système de Gestion de Qualité selon la norme internationale ISO9001:2015.

The processes used for the design, manufacturing and commercialisation of dismantable pools by Manufacturas Gre S.A., as well as the commercialisation of associated products, are certified according to the Quality System according to the international ISO9001:2015 standard, which guarantees regularity and control in the quality of our products and processes.

I processi utilizzati per la progettazione, la costruzione e la vendita di piscine smontabili a marchio Manufacturas Gre S.A., oltre alla vendita di prodotti ad esse associati, sono certificati in base ai criteri del sistema di Gestione della Qualità secondo la norma internazionale ISO9001:2015, ciò garantisce la regolarità e il controllo della qualità dei nostri prodotti e dei processi produttivi.



## ISO 14001

Gracias a la implantación de un Sistema de Gestión Ambiental según la norma internacional ISO 14001: 2015, Manufacturas Gre S.A. se posiciona como una empresa socialmente responsable. Entre otras ventajas ambientales, optimizamos la gestión de recursos y residuos, reduciendo los impactos ambientales negativos derivados de nuestra actividad o aquellos riesgos asociados a situaciones accidentales.

Grâce à l'implémentation d'un Système de Gestion Environnementale conformément à la norme internationale ISO 14001:2015, Manufacturas Gre S.A. se positionne comme une entreprise socialement responsable. Parmi de nombreux avantages environnementaux, nous optimisons la gestion des ressources et des déchets, réduisant ainsi les impacts environnementaux négatifs et dérivés de notre activité ou les risques associés à des situations d'accidents.

Thanks to the implantation of an Environmental Management System according to the international ISO 14001:2015 standard, Manufacturas Gre S.A. is positioned as a socially responsible company. Among other environmental advantages, we optimise resources and residues, reducing negative environmental impact derived from our activity or those risks associated to accidental situations.

Grazie all'introduzione di un Sistema di Gestione Ambientale secondo la norma internazionale ISO 14001:2015, Manufacturas Gre S.A. si classifica tra le aziende socialmente responsabili. Ciò comporta vantaggi per l'ambiente come l'ottimizzazione della gestione delle risorse, la riduzione degli impatti ambientali negativi derivanti dall'attività di produzione o dei rischi associati a eventi accidentali.



## ARBITRAJE DE CONSUMO / CONSUMER ARBITRATION / ARBITRAGE DE CONSOMMATION / ARBITRATO DI CONSUMO

Manufacturas Gre S.A. está adherido a la Junta Arbitral de Consumo como muestra de predisposición a la solución amistosa de cualquier tipo de reclamación por parte de sus clientes.

Manufacturas Gre S.A. est membre du bureau d'Arbitrage de Consommation, comme preuve de prédisposition à la solution amiable de tout type de réclamation de la part de ses clients.

Manufacturas Gre S.A. is adhered to the Consumer Arbitration Directorate evidencing predisposition to a friendly solution to any type of reclamation from its clients.

Manufacturas Gre S.A. aderisce alla Giunta Arbitrale di Consumo come segnale di predisposizione alla soluzione amichevole di qualsiasi tipo di reclamo da parte dei propri clienti.



## CE

Los productos distribuidos por Manufacturas Gre S.A. con el marcado CE cumplen todos los requisitos legales vigentes en Europa.

Les produits distribués par Manufacturas Gre S.A. dotés du marquage CE répondent à toutes les obligations légales en vigueur en Europe.

The products distributed by Manufacturas Gre S.A., with the CE marking comply with all the legal requirements in force in Europe.

I prodotti distribuiti da Manufacturas Gre S.A. con il marchio CE rispettano tutti i requisiti legali vigenti in Europa.







## EN 16582-1:2015, EN 16582-3:2015, EN 16713-1:2015

Estas certificaciones garantizan que las piscinas, filtros y escaleras fabricados y/o distribuidos por Manufacturas Gre S.A. cumplen con las normativas de seguridad establecidas.

These certifications guarantee that the pools, filters and stepladders manufactured and/or commercialised by Manufacturas Gre S.A. comply with the established safety regulations.

Ces certifications garantissent que les piscines, les filtres et les échelles fabriqués et/ou distribués par Manufacturas Gre S.A. respectent les normes de sécurité établies.

Queste certificazioni garantiscono che le piscine, i filtri e le scalette prodotti e/o distribuiti da Manufacturas Gre S.A. rispettano le normative di sicurezza previste.

## ECOEMBES



Manufacturas Gre S.A. está adherida a un sistema de recogida y reciclaje selectivo de los materiales que pone en el mercado con el fin último de preservar el medio ambiente.

Manufacturas Gre S.A. is adhered to a system for the selective collection and recycling of the materials it puts on the market in order to conserve the environment.

Manufacturas Gre S.A. est membre d'un système de collecte et de recyclage sélectif des matériaux qu'elle met sur le marché, dans le but de préserver l'environnement.

Manufacturas Gre S.A. aderisce a un sistema di raccolta differenziata e riciclaggio dei materiali immessi sul mercato, in un'ottica di preservazione dell'ambiente.

## REACH



Manufacturas Gre S.A. cumple con el reglamento Reach asegurando que todas las sustancias químicas que comercializa están registradas.

Manufacturas Gre S.A. complies with the Reach regulation ensuring that all the chemical substances it commercialises are registered.

Manufacturas Gre S.A. respecte le règlement Reach, qui garantit que toutes les substances chimiques qu'elle commercialise sont enregistrées.

Manufacturas Gre S.A. rispetta il regolamento Reach garantendo la registrazione di tutte le sostanze chimiche immesse sul mercato dall'azienda.

## ROHS

# RoHS

Manufacturas Gre S.A. cumple esta directiva para proteger el medio ambiente y la salud de las personas, evitando el uso de determinadas sustancias en aparatos eléctricos y electrónicos.

Manufacturas Gre S.A. complies with this directive to protect the environment and health of persons, avoiding the use of determined substances in electrical and electronic devices.

Manufacturas Gre S.A. respecte cette directive afin de protéger l'environnement et la santé des personnes, évitant ainsi l'utilisation de substances déterminées dans les appareils électriques et électroniques.

Manufacturas Gre S.A. rispetta questa normativa per proteggere l'ambiente e la salute delle persone, evitando l'utilizzo di determinate sostanze su dispositivi elettrici ed elettronici.

## PEFC



Manufacturas Gre S.A. cumple con los requisitos del Estándar de Cadena de Custodia de Productos Forestales PEFC ST 2002:2013.

Manufacturas Gre S.A. complies with the requirements of the Programme for the Endorsement of Forest Certification PEFC ST 2002:2013.

Manufacturas Gre S.A. respecte les conditions du Standard de la Chaîne de Contrôle de Produits Forestiers PEFC ST 2002:2013.

Manufacturas Gre S.A. rispetta i requisiti previsti dallo Standard della catena di custodia dei prodotti forestali PEFC ST 2002:2013.

## Origine France Garantie



**Origine France Garantie** es una marca cuyo principio es simple: 2 criterios son obligatorios.  
· Al menos el 50% del costo unitario es francés.  
· El producto tiene sus características esenciales en Francia.

**Origine France Garantie** is a brand whose principle of achievement is simple: 2 cumulative criteria are mandatory.

La etiqueta permite a las empresas **promover la producción en Francia** y los consumidores pueden optar por **comprar producto francés**.

· At least 50% of the unit cost is French.  
· The product has its essential characteristics in France.

**Origine France Garantie** est une marque dont le principe d'obtention est simple : 2 critères cumulatifs sont obligatoires.

The label allows companies to **promote production in France** and **consumers can choose to buy French**.

· au moins 50 % du prix de revient unitaire est français  
· le produit prend ses caractéristiques essentielles en France.

**Origine France Garantie** è un marchio il cui principio di realizzazione è semplice: 2 criteri cumulativi sono obbligatori.

Le label permet aux entreprises de promouvoir **le produire en France** et aux consommateurs de pouvoir **choisir d'acheter français**.

· Almeno il 50% del costo unitario è francese.  
· Il prodotto ha le sue caratteristiche essenziali in Francia.

L'etichetta consente alle aziende di **promuovere Prodotto in Francia** e i consumatori **possono scegliere di acquistare il francese**.



## PISCINA ENTERRADA DE PARED DE ACERO

**LINER:** Tratamiento Anti-ultravioleta que retrasa el envejecimiento del P.V.C.

**CHAPA:** Laminada en frío con tratamiento de galvanización, fosfatación e imprimación.

Troquelada para skimmer, válvulas de retorno y limpiafondos y focos.

## PISCINE ENTERRÉE PAROI ACIER

**LINER:** Traitement anti-ultraviolets contre le vieillissement du P.V.C.

**TÔLE:** Tôle laminée à froid et traitée par galvanisation, phosphatage, couche d'apprêt et laquage.

Découpage pour le skimmer, la buse de refoulement et la prise balai. Prédécoupe pour les projecteurs.

## IN-GROUND STEEL WALL POOL

**LINER:** Anti-ultraviolet treatment to slow down P.V.C aging.

**PLATE:** Galvanized, phosphatized, primed and lacquered cold-rolled plate.

Die cut for skimmer, return valve and cleaner openings and lights.

## PISCINE INTERRATA CON PARETI IN ACCIAIO

**LINER:** Trattamento Anti-ultravioletti - Ritarda l'invecchiamento del P.V.C.

**PANNELLO:** Laminata a freddo con trattamento di galvanizzazione, fosfatazione e preparazione.

Stampigliatura per Skimmer, valvola di ritorno e puliscifondi e spot.



**MADE  
IN  
EU**

in-ground pool

serie

MOOREA

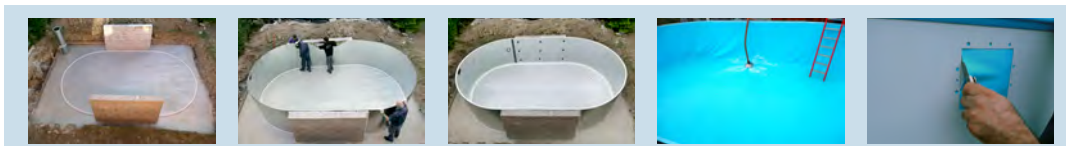

EAN 13

	800x400 cm	700x320 cm	600x320 cm	500x300 cm	150 cm	38.840 l	27.470 l	24.420 l	16.015 l	217/232 kg	189/232 kg	164/232 kg	139/232 kg	1/120x80 1/90x80	1/120x80 1/90x80	1/120x80 1/90x80	1/120x80 1/90x80	10m³/h	10m³/h	10m³/h	10m³/h	√	√	√	√	8 4 1 2 0 8 1 2 6 9 5 9 7	8 4 1 2 0 8 1 2 6 9 6 0 3	8 4 1 2 0 8 1 2 6 9 6 1 0	8 4 1 2 0 8 1 2 6 9 6 2 7			
KPEOV8059M																																
KPEOV7059M																																
KPEOV6059M																																
KPEOV5059M																																



MEDIDA PISCINA  
POOL SIZE  
DIMENSIONS PISCINE  
MISURA PISCINA

ESPACIO NECESARIO  
NECESSARY SPACE  
ESPACE NECESSAIRE  
SPAZIO NECESSARIO

KPEOV8059M	800x400x150 cm	1000x600x165 cm
KPEOV7059M	700x320x150 cm	900x520x165 cm
KPEOV6059M	600x320x150 cm	800x520x165 cm
KPEOV5059M	500x300x150 cm	700x500x165 cm



Liner PVC azul  
75/100  
PVC blue liner  
75/100  
Liner bleu PVC  
75/100  
Liner blu PVC  
75/100

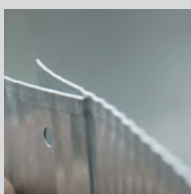

Chapa prelacada  
70/100  
Prelacquered steel  
70/100  
Tôle prélaquée  
70/100  
Lamiiera laccata  
70/100

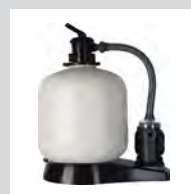

Depuradora arena  
(Caudal grupo 10/8 m³/h)  
Sand filter  
(Flow group 10/8 m³/h)  
Filtre à sable  
(Débit groupe 10/8 m³/h)  
Filtro a sabbia  
(Portata gruppo 10/8 m³/h)



**PLREB** BXL PACK 1



Proyector LED BLANCO para piscina enterrada.  
Projecteur LED BLANCHE pour piscine enterrée.

WHITE LED projector for in-ground pools.  
Faretto LED BIANCO per piscina interrata.

**PLREC** BXL PACK 1



Proyector LED COLOR para piscina enterrada.  
Con control remoto.  
Projecteur LED de COULEUR pour piscine enterrée.  
Avec télécommande.

COLOR LED projector for in-ground pools.  
With remote control.  
Faretto LED MULTICOLOR per piscina interrata.  
Include telecomando.



**EAN 13**

KPE4259M

Ø420 cm

150 cm

18.840 l

126/232 kg

1/120x80  
1/90x80

10m<sup>3</sup>/h

√

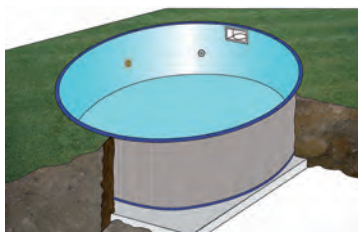

MEDIDA PISCINA  
POOL SIZE  
DIMENSIONS PISCINE  
MISURA PISCINA

ESPACIO NECESARIO  
NECESSARY SPACE  
ESPACE NECESSAIRE  
SPAZIO NECESSARIO

KPE4259M

Ø420x150 cm

Ø620x165 cm



Escalera fácil acceso:  
3 peldaños - Inox.  
Easy access ladder:  
3 steps - Stainless steel  
Échelle d'accès facile:  
3 marches - Acier inoxydable  
Scala di accesso facile:  
3 gradini - Inox



Manta protectora  
(Poliéster)  
Bottom protectiveblanket  
(Polyester)  
Tapis de sol en feutre  
(Polyester)  
Telo di protezione  
(Poliestere)



Skimmer, manguera,  
racordería...  
Skimmer, hose,  
fittings...  
Skimmer, tuyau,  
raccords...  
Skimmer, tubo,  
raccordería...

in-ground pool

serie

**MADAGASCAR**

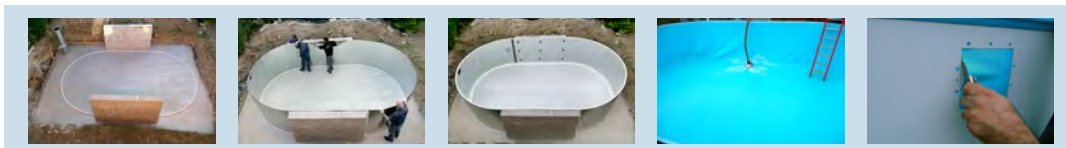

EAN 13

KPEOV8059	800x400 cm	150 cm	38.840 l	217/224 kg	1/120x80 1/90x80	10m <sup>3</sup> /h	√	8 4 4 2 0 8 1 2 6 9 3 2 0	
KPEOV7059	700x320 cm	150 cm	27.470 l	189/224 kg	1/120x80 1/90x80	10m <sup>3</sup> /h	√	8 4 4 2 0 8 1 2 6 9 3 3 7	
KPEOV6059	600x320 cm	150 cm	24.420 l	164/224 kg	1/120x80 1/90x80	10m <sup>3</sup> /h	√	8 4 4 2 0 8 1 2 6 9 3 4 4	
KPEOV5059	500x300 cm	150 cm	16.015 l	139/224 kg	1/120x80 1/90x80	10m <sup>3</sup> /h	√	8 4 4 2 0 8 1 2 5 8 9 0 4	



MEDIDA PISCINA  
POOL SIZE  
DIMENSIONS PISCINE  
MISURA PISCINA

ESPACIO NECESARIO  
NECESSARY SPACE  
ESPACE NECESSAIRE  
SPAZIO NECESSARIO

KPEOV8059	800x400x150 cm	1000x600x165 cm
KPEOV7059	700x320x150 cm	900x520x165 cm
KPEOV6059	600x320x150 cm	800x520x165 cm
KPEOV5059	500x300x150 cm	700x500x165 cm



Liner PVC azul  
75/100  
PVC blue liner  
75/100  
Liner bleu PVC  
75/100  
Liner blu PVC  
75/100

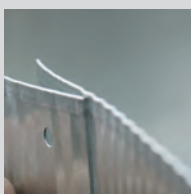

Chapa prelacada  
70/100  
Prelacquered steel  
70/100  
Tôle prélaquée  
70/100  
Lamiiera laccata  
70/100

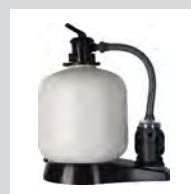

Depuradora arena  
(Caudal grupo 10/8 m<sup>3</sup>/h)  
Sand filter  
(Flow group 10/8 m<sup>3</sup>/h)  
Filtre à sable  
(Débit groupe 10/8 m<sup>3</sup>/h)  
Filtro a sabbia  
(Portata gruppo 10/8 m<sup>3</sup>/h)



EAN 13

KPE4259	Ø420 cm	150 cm	18.840 l	126/224 kg	1/120x80 1/90x80	10m <sup>3</sup> /h	√	8 4 1208 1 269351
---------	---------	--------	----------	------------	---------------------	---------------------	---	-------------------



MEDIDA PISCINA  
POOL SIZE  
DIMENSIONS PISCINE  
MISURA PISCINA

ESPACIO NECESARIO  
NECESSARY SPACE  
ESPACE NECESSAIRE  
SPAZIO NECESSARIO

KPE4259	Ø420x150 cm	Ø620x165 cm
---------	-------------	-------------



Escalera:  
4 peldaños - Inox.  
Ladder:  
4 steps - Stainless steel  
Échelle:  
4 marches - Acier inoxidable  
Scala:  
4 gradini - Inox



Manta protectora  
(Poliéster)  
Bottom protectiveblanket  
(Polyester)  
Tapis de sol en feutre  
(Polyester)  
Telo di protezione  
(Poliestere)



Skimmer, manguera,  
raccordo...  
Skimmer, hose,  
fittings...  
Skimmer, tuyau,  
raccords...  
Skimmer, tubo,  
raccorderia...

in-ground pool

serie

SUMATRA



EAN 13

Model	Dimensions (cm)	Depth (cm)	Capacity (l)	Weight (kg)	Box Size (cm)	Flow Rate (m³/h)	Installation	Barcode
KPEOV8027	800x400	120	30.000	193/222	1/120x80 1/90x80	10m³/h	√	8 4 12081 269368
KPEOV7027	700x320	120	21.210	173/222	1/120x80 1/90x80	10m³/h	√	8 4 12081 269375
KPEOV6027	600x320	120	17.850	154/222	1/120x80 1/90x80	10m³/h	√	8 4 12081 269382
KPEOV5027	500x300	120	12.360	134/222	1/120x80 1/90x80	10m³/h	√	8 4 12081 258959



MEDIDA PISCINA  
POOL SIZE  
DIMENSIONS PISCINE  
MISURA PISCINA

ESPACIO NECESARIO  
NECESSARY SPACE  
ESPACE NECESSAIRE  
SPAZIO NECESSARIO

Model	Pool Size (cm)	Necessary Space (cm)
KPEOV8027	800x400x120	1000x600x135
KPEOV7027	700x320x120	900x520x135
KPEOV6027	600x320x120	800x520x135
KPEOV5027	500x300x120	700x500x135



Liner PVC azul  
60/100  
PVC blue liner  
60/100  
Liner bleu PVC  
60/100  
Liner blu PVC  
60/100

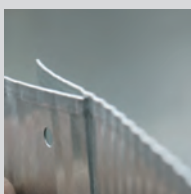

Chapa prelacada  
60/100  
Prelacquered steel  
60/100  
Tôle prélaquée  
60/100  
Lamiiera laccata  
60/100

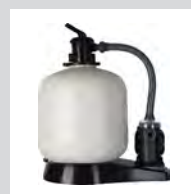

Depuradora arena  
(Caudal grupo 10/8 m³/h)  
Sand filter  
(Flow group 10/8 m³/h)  
Filtre à sable  
(Débit groupe 10/8 m³/h)  
Filtro a sabbia  
(Portata gruppo 10/8 m³/h)





EAN 13

	Ø	Height	Capacity	Weight	Box Size	Flow Rate	Filter	Barcode
KPE4227	Ø420 cm	120 cm	14.540 l	222/102 kg	1/120x80 1/90x80	10m <sup>3</sup> /h	√	8 412081 269399
KPE3527	Ø350 cm	120 cm	10.102 l	222/85 kg	1/120x80 1/90x80	10m <sup>3</sup> /h	√	8 412081 262635



MEDIDA PISCINA  
POOL SIZE  
DIMENSIONS PISCINE  
MISURA PISCINA

ESPACIO NECESARIO  
NECESSARY SPACE  
ESPACE NECESSAIRE  
SPAZIO NECESSARIO

Model	Pool Size	Necessary Space
KPE4227	Ø420x120 cm	Ø620x135 cm
KPE3527	Ø350x120 cm	Ø550x135 cm



Escalera:  
3 peldaños - Inox.  
Ladder:  
3 steps - Stainless steel  
Echelle:  
3 marches - Acier inoxydable  
Scala:  
3 gradini - Inox



Manta protectora  
(Poliéster)  
Bottom protectiveblanket  
(Polyester)  
Tapis de sol en feutre  
(Polyester)  
Telo di protezione  
(Poliestere)



Skimmer, manguera,  
racordería...  
Skimmer, hose,  
fittings...  
Skimmer, tuyau,  
raccords...  
Skimmer, tubi , kit  
raccordi...





## PISCINAS DE MADERA

**LINER:** Tratamiento Anti-ultravioleta que retrasa el envejecimiento del P.V.C

**MADERA:** Fabricadas en Francia en pino silvestre francés y con tratamiento en autoclave clase IV que garantiza la resistencia de la madera contra el ataque de insectos y pudrimiento. 10 años de garantía sobre la madera.

## WOODEN POOL

**LINER:** Anti-ultraviolet treatment to slow down P.V.C aging.

**WOODEN:** Manufactured in France from pine boards (originating in France), with a class IV autoclave treatment which guarantees its resistance to decay and xylophagous insects attack.

## PISCINE BOIS

**LINER:** Traitement anti-ultraviolets contre le vieillissement du P.V.C.

**BOIS:** De fabrication française et réalisées à partir de madriers en pin (origine France) bénéficiant d'un traitement par autoclave de classe IV, garantissant une résistance au pourrissement et aux attaques d'insectes xylophages. 10 ans de garantie sur les composants bois de la piscine.

## PISCINA IN LEGNO

**LINER:** Trattamento Anti-ultravioletti - Ritarda l'invecchiamento del P.V.C.

**LEGNO:** Prodotte in Francia in pino silvestre francese con trattamento in autoclave classe IV che garantisce la resistenza del legno agli insetti e al deterioramento. 10 anni di garanzia sulle parti in legno.



**MADE IN EU**

# La madera una historia The wood a story Le bois une histoire Il bosco una storia

## PINO SILVESTRE

**Manufacturas Gre** presenta piscinas con estructuras de madera de **pino silvestre**. Con un planteamiento de desarrollo sostenible, Manufacturas Gré cuenta **exclusivamente** con proveedores **locales en Francia**, de bosques de pinos denominados «del país». Asimismo, limitamos el transporte y las emisiones de gases de efecto invernadero. El PINO es la esencia de la clase de uso del autoclave IV, que garantiza resistencia frente a la podredumbre y a los insectos xilófagos.

El denominado pino «del país» presenta más albura que los pinos procedentes de bosques septentrionales. Además, ofrece una zona de impregnación más significativa, lo que asegura una vida útil superior a los diez años debido a una impregnación profunda en el autoclave. Este último es el único procedimiento normalizado y garantizado que aporta garantías a la durabilidad.

## LE PIN SYLVESTRE

**Manufacturas Gré** propose des piscines à ossatures bois en **pin sylvestre**. Dans une logique de développement durable, Manufacturas Gré s'approvisionne **localement et exclusivement en France**, auprès de forêts de pin dit « de pays ». Nous limitons ainsi le transport et les émissions de gaz à effet de serre.

Le PIN est l'essence idéale pour la classe d'emploi autoclave IV, garantissant une résistance au pourrissement et aux attaques d'insectes xylophages. Le pin dit « de pays » présente **plus d'aubier** que les pins des forêts du nord. Il offre ainsi **une zone d'imprégnation plus importante** lui garantissant une durée de service supérieure à 10 ans grâce à l'imprégnation profonde en autoclave. Ce dernier est le seul procédé normalisé et certifié apportant des garanties dans la durée.



## SCOTS PINE

**Manufacturas Gre** presents pools with **Scots pine** wood structures. With its proposal for sustainable development, Manufacturas Gré exclusively uses **local French** suppliers, from forests of pine wood denominated «local pine». Likewise, we limit transport and emissions of greenhouse gases. PINE is the essence of the class used in Autoclave IV that guarantees resistance against rot and xylophagous insects.

The so-called «local pine» has more whiteness than pines coming from northern forests. In addition, it offers a more significant impregnation area, which assures a useful life above ten years due to deeper impregnation in the autoclave. This latter is the only standardised and guaranteed process proving guaranteed durability.

## LE PIN SYLVESTRE

Manufacturas Gre è lieta di presentare le piscine con struttura in legno di pino silvestre.

Con un approccio rivolto allo sviluppo sostenibile, Manufacturas Gré si affida esclusivamente a fornitori locali in Francia, di legno proveniente da foreste di pini "autoctoni".

Vengono limitati il trasporto e le emissioni di gas serra.

Il PINO subisce un trattamento in autoclave classe IV, che garantisce resistenza al deterioramento e agli insetti xilofagi.

Il cosiddetto pino "autoctono" presenta una quantità maggiore di alburo rispetto ai pini provenienti dalle foreste settentrionali. Offre inoltre una maggiore area di impregnazione, che garantisce una durata utile superiore a dieci anni grazie a una profonda impregnazione in autoclave.

Quest'ultima è l'unica procedura standardizzata e garantita che aporta garantías de durabilidad.



## CERTIFICACIONES

### PRODUCTOS CERTIFICADOS POR PEFC

(Programa europeo de certificación forestal)

Licencia número: PEFC/14-38-00166

+Pioneros en la certificación forestal en Francia, PEFC acoge en la actualidad 8,1 millones de hectáreas, 62 000 propietarios y 3000 empresas del sector maderero forestal (explotaciones, aserraderos, industrias de transformación, construcciones, intermediarios comerciales, distribuidores, industrias papeleras, imprentas, editoriales, etc.). En conjunto, aportan al consumidor la garantía de que el producto que lleve la marca PEFC se enmarca en una estrategia responsable de gestión forestal sostenible.

## CERTIFICATION

### PRODUITS LABELLISÉS PEFC

(Programme Européen des Forêts Certifiées)

N° licence : PEFC/14-38-00166

Pionier de la certification forestière en France, PEFC représente aujourd'hui 8,1 millions d'hectares, 62 000 propriétaires et 3 000 entreprises de la filière forêt-bois (exploitants, scieries, transformateurs, constructeurs, négociants, artisans, distributeurs, papetiers, imprimeurs, éditeurs...). Ensemble ils apportent au consommateur la garantie qu'un produit portant la marque PEFC s'inscrit dans une démarche responsable de gestion durable de la forêt.

[www.pefc.es](http://www.pefc.es) / [www.pefc-france.org](http://www.pefc-france.org)

Nuestra madera procede de bosques gestionados de forma responsable y sostenible, certificados como PEFCM. Our wood comes from responsibly and sustainably managed forests, certified with PEFCM. Notre bois est issu de forêts gérées de façon responsable et durable, certifiées PEFCM. Il nostro legno proviene da foreste gestite in modo responsabile e sostenibile, certificate come PEFCM.

## CERTIFICATION

### PRODUCTS CERTIFIED BY PEFC

(European programme for forestry certification)

License number: PEFC/14-38-00166

Pioneers in forestry certification in France, PEFC currently includes 8.1 million hectares, 62,000 owners, and 3,000 forest timber sector companies (exploitations, sawmills, transformation industries, constructions, commercial intermediaries, distributors, paper industries, printers, publishers, etc.). Overall, they provide the consumer with the guarantee that the product with PEFC marking is framed within a responsible strategy of sustainable forest management.

## CERTIFICAZIONE

### PRODOTTI CERTIFICATI DAL PEFC

(Programma europeo di certificazione forestale)

Licenza numero: PEFC/14-38-00166

Pionieri nella certificazione forestale in Francia, PEFC conta attualmente 8,1 milioni di ettari, 62.000 proprietari e 3000 aziende nel settore del legno (aziende agricole, segherie, industrie di trasformazione, settore edile, intermediari commerciali, distributori, cartiere, stamperia, editorie, ecc.). Uniti nell'intento di offrire ai consumatori la garanzia che il prodotto a marchio PEFC faccia parte di una strategia responsabile per la gestione sostenibile delle foreste.





La certificación **CTB B+** solo indica el uso de un producto de tratamiento conforme a los criterios de la certificación. Pivetau Bois cuenta con la certificación **CTB B+** (con el respaldo de la asociación Arbust). El certificado CTB B+ confirma la utilización de productos de tratamiento con la **certificación CTB B+**, así como **la conformidad del proceso y su eficacia**.

Le **CTB P+** atteste uniquement de l'utilisation d'un produit de traitement conforme aux critères de la certification. Pivetau Bois est certifié **CTB B+** (soutenu par l'association Arbust). Le certificat **CTB B+** atteste de l'utilisation de produit de traitement certifié CTB P+ et **atteste aussi de la conformité du processus et de son efficacité**.

The **CTB B+** certification only indicates the use of a treatment product in accordance to certification criteria. Pivetau Bois has the **CTB B+** certification (with the backing of the Arbust association). The **CTB B+** confirms the use of treatment products with **CTB B+ certification**, as well as **process conformity and efficiency**.

La certificazione **CTB B +** indica l'utilizzo di un prodotto di trattamento conforme ai criteri della certificazione.

Pivetau Bois è in possesso della certificazione **CTB B +** (con il supporto dell'associazione Arbust).

La certificazione **CTB B +** conferma l'utilizzo di prodotti per il trattamento con la certificazione **CTB B +**, nonché **la conformità del processo e la sua efficacia**.

## Tratamiento autoclave Autoclave treatment Le traitement autoclave Trattamento in autoclave

El tratamiento en el autoclave es **la mejor solución** para proteger las maderas expuestas de forma directa a la intemperie o en contacto con el suelo y consiste en **impregnar conservantes hasta el núcleo de la madera**.

Le traitement par autoclavage est **la meilleure solution** pour protéger les bois exposés directement aux intempéries ou en contact avec le sol et consiste à **imprégner des agents de conservation jusqu'au cœur du bois**.

Treatment in the autoclave is **the best solution** for protecting wood directly exposed to outdoor weather or in contact with the ground and consists of **impregnating preservatives into the core of the wood**.

Il trattamento in autoclave è la **soluzione migliore** per proteggere il legno esposto direttamente alle intemperie o a contatto con il terreno e consiste **nell'impregnare conservanti nel nucleo del legno**.



### INSTALACIÓN

Libre elección de instalación (excepto para la piscina rectangular 8x4, obligatoriamente semienterrada a 60 cm): en superficie, semienterrada o enterrada. En estos dos últimos casos, es obligatorio acondicionar un drenaje en todo el perímetro del vaso (consultar el aviso).

### IMPLANTATION

Implantation libre de choix (hors piscine rectangulaire 8x4 obligatoirement semi-enterrée de 60 cm) : hors-sol, semi-enterrée jusqu'à complètement enterrée. En cas d'implantation semi-enterrée ou totalement enterrée, il est impératif de réaliser un drainage sur toute la périphérie du bassin (cf notice)

### INSTALLATION

Free choice of installation (except for 8x4 rectangular pools, compulsory semi-embedded or embedded) In these two latter cases, there must be drainage in the entire perimeter of the pool (check warning)

### INSTALLAZIONE

Libera installazione (ad eccezione della piscina rettangolare 8 x 4, per cui è obbligatoria l'installazione semi-interrata a 60 cm): superficiale, semi-interrata o interrata. In questi ultimi due casi, è obbligatorio predisporre un drenaggio attorno al perimetro della vasca (consultare le specifiche indicazioni).

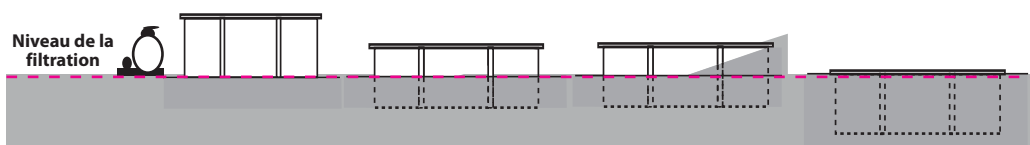

Todas las dimensiones de nuestras piscinas se presentan con una tolerancia de +/- 3 % · Todas las dimensiones de nuestras piscinas se presentan con una tolerancia de +/- 3 % · Toutes les dimensions de nos piscines sont données avec une tolérance de +/- 3% · Tutte le dimensioni delle nostre piscine vengono indicate con una tolleranza di +/- 3%.

# Piscinas de madera Wood pools Les piscines bois Piscine in legno

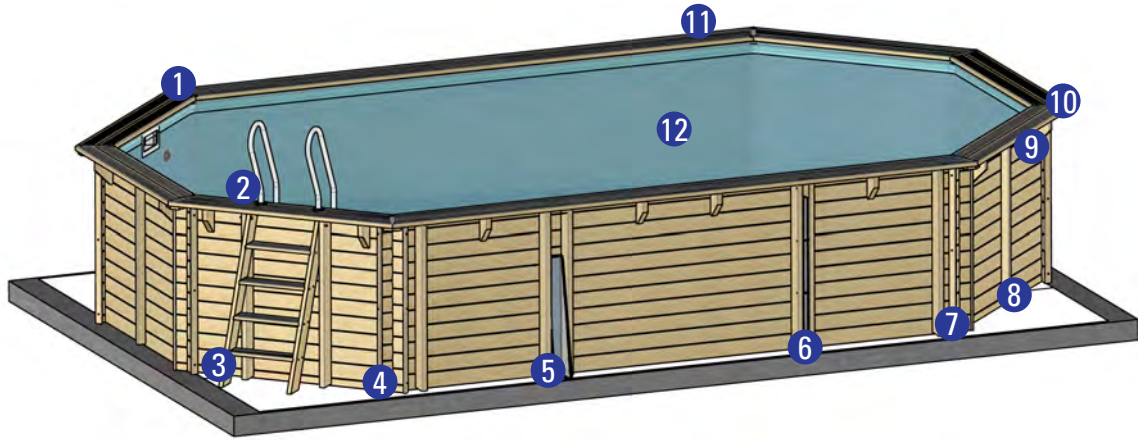

**1: Stainless steel corners** According to model **2: Stainless steel ladder** Fixed - 3 non-slip steps **3: Wood ladder** Possibility of readjusting the wood ladder according to the height of the pool. **4: Angular finishing** The wood coating at the ends of the boards provides greater aesthetics to the pool **5: Wedges** Reinforcement wedges for fixing on concrete slab **6: Nerves** Metallic nerves for embedding in concrete slab **7: Tongue and groove series** Boards are fitted to each other by a cross at the end - Simple tongue and groove facilitating assembly and that way avoiding risk of breakage. **8: Vertical reinforcements** Vertical resistance thanks to wood reinforcements **9: Corbels** Corbels are used to sustain the edges **10: Plates under edges** Allow reinforcing the installation of edges on the corners **11: Wood edges** Made from Scots pine treated in class IV autoclave - Single (190 mm) or double (2 x 145 mm) according to model - Thickness of 28 mm or of 36 mm according to model **12: Liner** Baguettes Hung

**1: Embellecedor de esquinas inoxidable** Según el modelo **2: Escalera inoxidable** Fija - 3 Escalones antideslizantes **3: Escalera de madera** Posibilidad de reajustar la escalera de madera según la altura del vaso **4: Embellecedor angular** El revestimiento de madera en los extremos de los tablones perfecciona la estética del vaso **5: Cuñas metálicas** Cuñas de refuerzo para fijar sobre la losa de hormigón **6: Vigas** Vigas metálicas para encastrar en la losa de hormigón **7: Conjunto de ranura y lengüeta** Encaje de tablones entre ellos mediante cruce de los extremos - Ranura y lengüeta sencillas para facilitar el montaje y así evitar el riesgo de rotura **8: Refuerzos verticales** Resistencia vertical gracias a los refuerzos de madera **9: Tacos de madera** Los tacos se emplean para sostener las playas **10: Tacos bajo playa** Permiten reforzar la instalación de las playas en las esquinas **11: Playas de madera** De pino silvestre tratado en autoclave de clase IV - Simple (190 mm) o doble (2 x 145 mm) según el modelo - Grosor de 28 mm o de 36 mm según el modelo **12: Liner** Perfil colgate

**1: Cache Angles Inox** Selon modèle **2: Échelle Inox** Amovible - 3 marches anti-dérapantes **3: Échelle Bois** Possibilité de réajuster l'échelle bois selon la hauteur du bassin **4: Cache L** Un habillage bois aux extrémités des madriers vient parfaire l'esthétisme du bassin **5: Sabots** Renforts sabot à fixer sur la dalle béton **6: Berceaux** Berceaux métalliques à noyer dans la dalle béton **7: Assemblage Rainure languette** Emboîtement des madriers les uns sur les autres en se croisant à leurs extrémités - Simple rainure / languette pour faciliter le montage et éviter ainsi le risque de casse **8: Renforts verticaux** Résistance verticale grâce aux renforts bois **9: Consoles** Les consoles sont destinées à soutenir les margelles **10: Plaques sous margelles** Permet de renforcer l'assemblage des margelles dans les angles **11: Margelles Bois** En pin Sylvestre traité autoclave classe IV - Simple (190 mm) ou double (2 x 145 mm) selon modèle - Epaisseur 28 mm ou 36 mm selon modèle **12: Liner** Baguettes Hung

**1: Rivestimento per angoli in acciaio inox** In base al modello **2: Scaletta in acciaio inox** Fissa - 3 scalini antiscivolo **3: Scaletta in legno** Possibilità di regolare la scaletta in base all'altezza della vasca **4: Rivestimento angolare** Il rivestimento in legno posto alle estremità dei pannelli perfeziona l'estetica della vasca **5: Cunei** Cunei di rinforzo da fissare sulla lastra in calcestruzzo **6: Nervature** Nervature metalliche da incastrare nella lastra in calcestruzzo **7: Set composto da scanalatura e linguetta** Incastrare i pannelli tra loro incrociando le estremità - Scanalatura e linguetta per facilitare il montaggio evitando il rischio di rottura **8: Rinforzi verticali** Resistenza verticale grazie ai rinforzi in legno **9: Mensole** Le mensole vengono utilizzate per sostenere i bordi **10: Piastre poste sotto al bordo** Permettono di rinforzare i bordi negli angoli **11: Bordi in legno** Realizzati in legno di pino silvestre con trattamento in autoclave in classe IV - Semplice (190 mm) o doppio (2 x 145 mm) a seconda del modello - Spessore 28 mm o 36 mm a seconda del modello **12: Liner** Baguettes Hung

# Refuerzos de estructura Structural reinforcements Renforts de structure Rinforzi strutturali

## CUÑA METÁLICA :

La cuña se fija sobre la losa de hormigón. Por lo tanto, permite construir la losa, con un espesor mínimo de 15 cm, antes de montar el vaso (consultar el manual de instalación y el vídeo de montaje). Los refuerzos tienen un revestimiento de madera para garantizar su integración y su estética.

## LE SABOT :

Le sabot vient se fixer sur la dalle en béton. Il est donc possible de réaliser la dalle, épaisseur 15 cm minimum, préalablement au montage du bassin (cf. notice de montage et vidéo de montage).

Les renforts de structures reçoivent un habillage bois, pour une intégration et un esthétisme assuré.

## WEDGE :

The wedge is fixed on the concrete slab. Therefore, this allows preparing the concrete slab, with minimum thickness of 15 cm before assembling pool (check installation warning and assembly video). Structural reinforcements are coated with wood to guarantee their integration and aesthetics.

## CUNEO METALLICO :

Il cuneo viene fissato sulla lastra di calcestruzzo. Consente pertanto di costruire la lastra, con uno spessore minimo di 15 cm, prima di montare la vasca (consultare le indicazioni e il video di montaggio). I rinforzi strutturali sono provvisti di una copertura in legno che ne migliorano il posizionamento e l'estetica.



## VIGAS METÁLICAS:

Las vigas metálicas se encastran en la losa de hormigón, con un espesor mínimo de 17 cm. Su colocación forma parte del proceso de montaje de la estructura (consultar el manual de instalación).

## LE BERCEAU :

Les berceaux métalliques sont à **noyer dans la dalle béton**, épaisseur **17 cm minimum**. Leur pose fait partie intégrante du montage de la structure (cf. notice de montage).

## BURIED STEEL BEAM :

Buried steel beam are embedded in the concrete slab, with a minimum thickness of 17 cm. Their installation is part of the structure assembly process (check installation warning).

## BARRA DI ACCIAIO:

La barra di acciaio vengono incassate nella lastra di calcestruzzo, con uno spessore minimo di 17 cm.

Il loro posizionamento fa parte del processo di assemblaggio della struttura (vedere indicazioni per il montaggio).

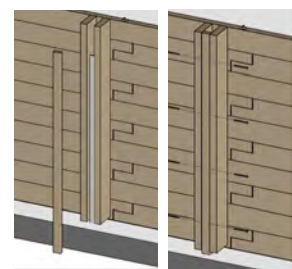
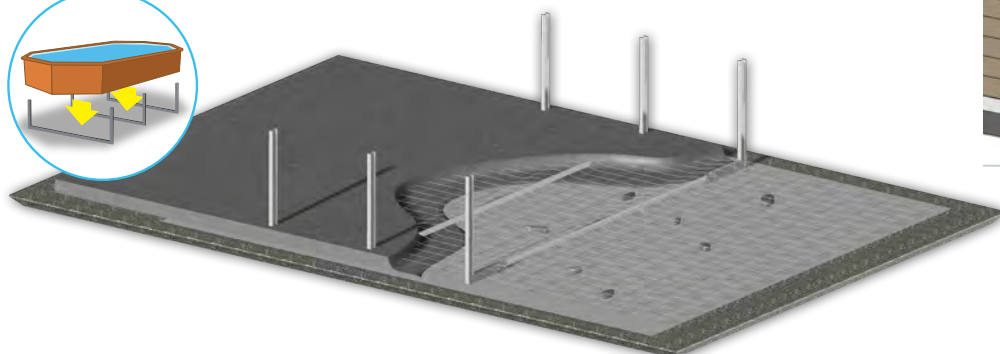
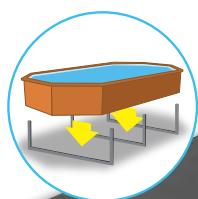

wooden pool

# VIOLETTE · VANILLE · LILI

H. 1,24 - 1,19m- 1,05m



REFERENCIA RÉFÉRENCE	REFERENCE RIFERIMENTO
 CÓDIGO EAN GENCOD	EAN CODE CODICE A BARRE
 EXTERIORES EXTÉRIEURES	OUTSIDE ESTERNO
 INTERIORES INTÉRIEURES	INSIDE INTERNI
 VOLUMEN DE AGUA VOLUME D'EAU	WATER VOLUME VOLUME DI ACQUA
 PANELES PANS	PANELS PANNELLI
 LINEA DE AGUA LIGNE D'EAU	WATER LINE LINEA DELL'ACQUA
 ESTRUCTURA STRUCTURE	STRUCTURE STRUTTURA
 PLAYAS MARGELLES	EDGES BORDI
 ESPESOR MADERA ÉPAISEUR MADRIER	WOOD THICKNESS DIMENSIONE
 LINER	
 FILTRACIÓN FILTRATION	FILTRATION FILTRO
 PROTECTOR DE FONDO FEUTRE DE FOND	FLOOR PROTECTOR PROTEZIONE DEL FONDO
 PROTECTOR DE PARED FEUTRE DE PAROI	WALL PROTECTOR COPERTURA DELLA PARETE
 ESCALERA INTERIOR ÉCHELLE INTÉRIEURE	INSIDE LADDER SCALA INTERNA
 ESCALERA EXTERIOR ÉCHELLE EXTÉRIEURE	OUTSIDE LADDER SCALA ESTERNA
 TERRENO SUPPORT	LAND TERRENO
 PALET	
 IMPLANTATION	



## VIOLETTE

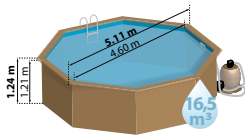

## VANILLE

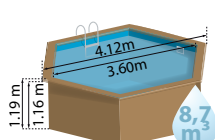

## VANILLE

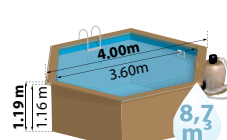

## LILI



**790085**

🇫🇷 LDD: **790085D**

3605217900852

LDD: 8412081003276

Ø 5,11 x H. 1,24 m

Ø 4,60 x H. 1,21 m

16,5 m<sup>3</sup>

8

1,11 m

**790083**

3605217900838

Ø 4,12 x H. 1,19 m

Ø 3,60 x H. 1,16 m

8,7 m<sup>3</sup>

6

1,06 m

🇫🇷 **790082**

🇫🇷 LDD: **790082D**

3605217900821

LDD: 8412081003245

Ø 4,00 x H. 1,19 m

Ø 3,60 x H. 1,16 m

8,7 m<sup>3</sup>

6 pans

1,06 m

**790080**

🇫🇷 LDD: **790080D**

3605217900807

LDD: 8412081003221

Ø 2,95 x H. 1,05 m

Ø 2,55 x H. 1,01 m

4 m<sup>3</sup>

6

1,06 m

Pino silvestre francés y autoclave clase IV · Pine boards originating in France, with a class IV autoclave · Pin sylvestre origine France autoclave classe IV · pino silvestre francese con trattamento in autoclave classe IV - Certificado · Certificate · Certifié · Certificato PEFC

Ancho · Width · Largeur · Larghezza: 29 cm · Espesor · Thickness · Épaisseur · Dimensione: 2,8 cm · Embellecedores metálicos · metal covers · caches angles inox · protezione metallico inox

Ancho · width · largeur · larghezza: 19 cm · Espesor · Thickness · épaisseur · dimensione: 2,8cm

46 mm

46 mm

46 mm

46 mm

75/100<sup>e</sup> uni

50/100<sup>e</sup> uni

50/100<sup>e</sup> uni

50/100<sup>e</sup> uni

FILTRO DE ARENA · SAND FILTER · FILTRATION À SABLE · FILTRO A SABBIA

Aqualoon

6 m<sup>3</sup> /h

4 m<sup>3</sup>/h

4 m<sup>3</sup>/h

4 m<sup>3</sup>/h

Espeor · Thickness · Épaisseur · Dimensione  
200 g/m<sup>2</sup>



ACERO INOXIDABLE · STAINLESS STEEL · ACIER INOXIDABLE · ACCIAIO INOX

Escalera seguridad plataforma

Safety ladder platform

Échelle sécurité plateforme

Scala di sicurezza piattaforma

MADERA · WOOD · BOIS · LEGNO

Losa de hormigón opcional · Optional concrete slab · Chape béton facultative · Basamento di calcestruzzo opzionale

474 x 474 x H 10 cm  
2,25 m<sup>3</sup>

406 x 406 x H 10 cm  
1,64 m<sup>3</sup>

306 x 306 x H 10 cm  
0,94 m<sup>3</sup>

L 200 x l 120 x H 67,5 cm - 780 kg  
L 80 x l 120 x H 78 cm - 120 kg

L 208 x l 120 x H 50 cm - 540 kg  
L 80 x l 120 x H 78 cm - 105 kg

L 208 x l 120 x H 50 cm - 540 kg  
L 80 x l 120 x H 78 cm - 105 kg

L 150 x l 120 x H 45 cm - 360 kg  
L 80 x l 120 x H 115 cm - 62,5 kg

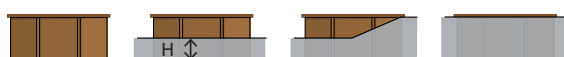

wooden pool

# AVILA · SEVILLA · VERMELA

H. 1,46 m



	REFERENCIA RÉFERENCE	REFERENCE RIFERIMENTO
	CÓDIGO EAN GENCOD	EAN CODE CODICE A BARRE
	EXTERIORES EXTÉRIEURES	OUTSIDE ESTERNO
	INTERIORES INTÉRIEURES	INSIDE INTERNI
	VOLUMEN DE AGUA VOLUME D'EAU	WATER VOLUME VOLUME DI ACQUA
	PANELES PANS	PANELS PANNELLI
	LINEA DE AGUA LIGNE D'EAU	WATER LINE LINEA DELL'ACQUA
	ESTRUCTURA STRUCTURE	STRUCTURE STRUTTURA
	PLAYAS MARGELLES	EDGES BORDI
	ESPESOR MADERA ÉPAISEUR MADRIER	WOOD THICKNESS DIMENSIONE
	LINER	
	FILTRACIÓN FILTRATION	FILTRATION FILTRO
	PROTECTOR DE FONDO FEUTRE DE FOND	FLOOR PROTECTOR PROTEZIONE DEL FONDO
	PROTECTOR DE PARED FEUTRE DE PAROI	WALL PROTECTOR COPERTURA DELLA PARETE
	ESCALERA INTERIOR ÉCHELLE INTÉRIEURE	INSIDE LADDER SCALA INTERNA
	ESCALERA EXTERIOR ÉCHELLE EXTÉRIEURE	OUTSIDE LADDER SCALA ESTERNA
	TERRENO SUPPORT	LAND TERRENO
	PALET	
	IMPLANTATION	

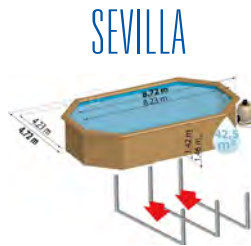
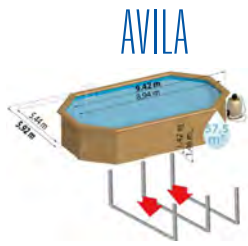

**790092**

**790091**

**790098**

🇫🇷 LDD: **790091D**

🇫🇷 LDD: **790098D**

3605217900852

3605217900913  
LDD: 8412081003337

3605217900982  
LDD: 841208100320

9,42 x 5,92 x H. 1,46 m

8,72 x 4,72 x H. 1,46 m

6,72 x 4,72 x 1,46 m

8,94 x 5,44 x H. 1,42 m

8,23 x 4,23 x H. 1,42 m

6,23 x 4,23 x 1,42 m

57,5 m<sup>3</sup>

42,5 m<sup>3</sup>

31 m<sup>3</sup>

8

8

8

1,36 m

1,36 m

1,36 m

Pino silvestre francés y autoclave clase IV · Pine boards originating in France, with a class IV autoclave · Pin sylvestre origine France autoclave classe IV · pino silvestre francese con trattamento in autoclave classe IV - Certificado · Certificate · Certifié · Certificato PEFC

Ancho · Width · Largeur · Larghezza: 29 cm · Espesor · Thickness · Épaisseur · Dimensione: 3,6 cm  
Embellecedores metálicos · Metal covers · Caches angles inox · Protezione metallico inox

46 mm

46 mm

46 mm

75/100<sup>e</sup> uni

75/100<sup>e</sup> uni

75/100<sup>e</sup> uni

FILTRO DE ARENA · SAND FILTER · FILTRATION À SABLE · FILTRO A SABBIA

16 m<sup>3</sup> /h

12 m<sup>3</sup>/h

12 m<sup>3</sup>/h

Espeor · Thickness · Épaisseur · Dimensione  
200 g/m<sup>2</sup>



ACERO INOXIDABLE · STAINLESS STEEL · ACIER INOXIDABLE · ACCIAIO INOX

MADERA · WOOD · BOIS · LEGNO

Losa de hormigón obligatorio · Obligatory concrete slab · Chape béton Obligatoire · Basamento di calcestruzzo obbligatorio

944 x 594 x H 17 cm  
9,55 m<sup>3</sup>

874 x 474 x H 17 cm  
7,04 m<sup>3</sup>

674 x 474 x H 17 cm  
5,43 m<sup>3</sup>

L 600 x l 120 x H 55cm - 1600 kg  
L 80 x l 200 x H 100 cm - 300 kg

L 600 x l 120 x H 50,5cm - 1500 kg  
L 200 x l 80 x H 100 cm - 320 kg

L 400 x l 120 x H 55cm - 1200 kg  
L 200 x l 80 x H 100 cm - 300 kg

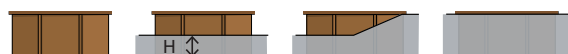

wooden pool

# SAFRAN · CANNELLE · BOGOTA · GRENADÉ

H. 1,33 - 1,19m



	REFERENCIA RÉFÉRENCE	REFERENCE RIFERIMENTO
	CÓDIGO EAN GENCOD	EAN CODE CODICE A BARRE
	EXTERIORES EXTÉRIEURES	OUTSIDE ESTERNO
	INTERIORES INTÉRIEURES	INSIDE INTERNI
	VOLUMEN DE AGUA VOLUME D'EAU	WATER VOLUME VOLUME DI ACQUA
	PANELES PANS	PANELS PANNELLI
	LINEA DE AGUA LIGNE D'EAU	WATER LINE LINEA DELL'ACQUA
	ESTRUCTURA STRUCTURE	STRUCTURE STRUTTURA
	PLAYAS MARGELLES	EDGES BORDI
	ESPESOR MADERA ÉPAISEUR MADRIER	WOOD THICKNESS DIMENSIONE
	LINER	
	FILTRACIÓN FILTRATION	FILTRATION FILTRO
	PROTECTOR DE FONDO FEUTRE DE FOND	FLOOR PROTECTOR PROTEZIONE DEL FONDO
	PROTECTOR DE PARED FEUTRE DE PAROI	WALL PROTECTOR COPERTURA DELLA PARETE
	ESCALERA INTERIOR ÉCHELLE INTÉRIEURE	INSIDE LADDER SCALA INTERNA
	ESCALERA EXTERIOR ÉCHELLE EXTÉRIEURE	OUTSIDE LADDER SCALA ESTERNA
	TERRENO SUPPORT	LAND TERRENO
	PALET	
	IMPLANTATION	

## SAFRAN



## CANNELLE



## BOGOTA

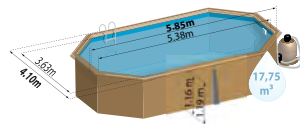

## GRENADE

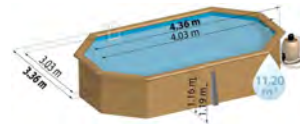

**790089**

🇫🇷 LDD: **790089D**

3605217900890

LDD: 8412081003313

6,37 x 4,12 x H. 1,33 m

5,90 x 3,65 x H. 1,30 m

23 m<sup>3</sup>

8

1,20 m

**790087**

🇫🇷 LDD: **790087D**

3605217900876

LDD: 8412081003290

5,51 x 3,51 x H. 1,19 m

5,03 x 3,03 x H. 1,16 m

14,5 m<sup>3</sup>

8

1,06 m

🇫🇷 Mag: **790088**

🇫🇷 LDD: **790088D**

Mag: 3605217900883

LDD: 8412081003306

5,85 x 4,10 x H. 1,19 m

5,38 x 3,63 x H. 1,16 m

17,75 m<sup>3</sup>

8 pans

1,06 m

**790086**

🇫🇷 LDD: **790086D**

3605217900869

LDD: 8412081003283

4,36 x 3,36 x H. 1,19 m

4,03 x 3,03 x H. 1,16 m

11,2 m<sup>3</sup>

8

1,06 m

Pino silvestre francés y autoclave clase IV · Pine boards originating in France, with a class IV autoclave · Pin sylvestre origine France autoclave classe IV · pino silvestre francese con trattamento in autoclave classe IV · Certificado · Certificate · Certifié · Certificato PEFC

Ancho · Width · Largeur · Larghezza: 29 cm, GRENADE: 19cm · Espesor · Thickness · Épaisseur · Dimensione: 2,8 cm  
Embellecedores metálicos · Metal covers · Caches angles inox · Protezione metallico inox

46 mm

46 mm

46 mm

46 mm

75/100<sup>e</sup> uni

60/100<sup>e</sup> uni

75/100<sup>e</sup> uni

60/100<sup>e</sup> uni

FILTRO DE ARENA · SAND FILTER · FILTRATION À SABLE · FILTRO A SABBIA

8 m<sup>3</sup>/h

6 m<sup>3</sup>/h

6 m<sup>3</sup>/h

4 m<sup>3</sup>/h

Espesor · Thickness · Épaisseur · Dimensione  
200 g/m<sup>2</sup>



ACERO INOXIDABLE · STAINLESS STEEL · ACIER INOXIDABLE · ACCIAIO INOX

MADERA · WOOD · BOIS · LEGNO

Losa de hormigón obligatorio · Obligatory concrete slab · Chape béton Obligatoire · Basamento di calcestruzzo obbligatorio

638 x 463 x H 15 cm  
4,43 m<sup>3</sup>

553 x 403 x H 15 cm  
3,34 m<sup>3</sup>

L 648 x l 480 x H 15 cm soit  
4,66 m<sup>3</sup>

453 x 403 x H 15 cm  
2,74 m<sup>3</sup>

L 400 x l 120 x H 50 cm - 1000 kg  
L 80 x l 120 x H 100 cm - 120 kg

L 350 x l 120 x H 48 cm - 770 kg  
L 80 x l 120 x H 100 cm - 90 kg

L 350 x l 120 x H 50 cm - 860 kg  
L 80 x l 120 x H 100 cm - 90 kg

L 299 x l 120 x H 44 cm - 650 kg  
L 80 x l 120 x H 78 cm - 100 kg

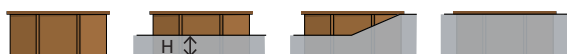

wooden pool

# CARDAMON · MINT · ANISE

H. 1,46 m



	REFERENCIA RÉFÉRENCE	REFERENCE RIFERIMENTO
	CÓDIGO EAN GENCOD	EAN CODE CODICE A BARRE
	EXTERIORES EXTÉRIEURES	OUTSIDE ESTERNO
	INTERIORES INTÉRIEURES	INSIDE INTERNI
	VOLUMEN DE AGUA VOLUME D'EAU	WATER VOLUME VOLUME DI ACQUA
	PANELES PANS	PANELS PANNELLI
	LINEA DE AGUA LIGNE D'EAU	WATER LINE LINEA DELL'ACQUA
	ESTRUCTURA STRUCTURE	STRUCTURE STRUTTURA
	PLAYAS MARGELLES	EDGES BORDI
	ESPESOR MADERA ÉPAISEUR MADRIER	WOOD THICKNESS DIMENSIONE
	LINER	
	FILTRACIÓN FILTRATION	FILTRATION FILTRO
	PROTECTOR DE FONDO FEUTRE DE FOND	FLOOR PROTECTOR PROTEZIONE DEL FONDO
	PROTECTOR DE PARED FEUTRE DE PAROI	WALL PROTECTOR COPERTURA DELLA PARETE
	ESCALERA INTERIOR ÉCHELLE INTÉRIEURE	INSIDE LADDER SCALA INTERNA
	ESCALERA EXTERIOR ÉCHELLE EXTÉRIEURE	OUTSIDE LADDER SCALA ESTERNA
	TERRENO SUPPORT	LAND TERRENO
	PALET	
	IMPLANTATION	

## CARDAMON

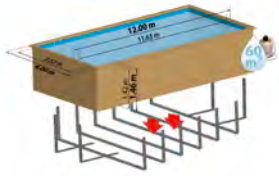

**788033**

## MINT



**788032**

## ANISE



**788031**

3605217880338

3605217880321

3605217880314

12,18 x 4,27 x H. 1,46 m

10,18 x 4,27 x H. 1,46 m

9,18 x 3,27 x H. 1,46 m

11,63 x 3,80 x H. 1,42 m

9,63 x 3,80 x H. 1,42 m

8,63 x 2,80 x H. 1,42 m

60 m<sup>3</sup>

50 m<sup>3</sup>

35 m<sup>3</sup>

4

4

4

1,36 m

1,36 m

1,36 m

Pino silvestre francés y autoclave clase IV · Pine boards originating in France, with a class IV autoclave · Pin sylvestre origine France autoclave classe IV · pino silvestre francese con trattamento in autoclave classe IV - Certificado · Certificate · Certifié · Certificato PEFC

Ancho · Width · Largeur · Larghezza: 29 cm · Espesor · Thickness · Épaisseur · Dimensione: 3,6 cm  
Embellecedores metálicos · Metal covers · Caches angles inox · Protezione metallo inox

46 mm

46 mm

46 mm

75/100<sup>e</sup> uni

75/100<sup>e</sup> uni

75/100<sup>e</sup> uni

FILTRO DE ARENA · SAND FILTER · FILTRATION À SABLE · FILTRO A SABBIA

16 m<sup>3</sup> /h - 2 skimmer

16 m<sup>3</sup>/h - 2 skimmer

16 m<sup>3</sup>/h - 2 skimmer

Espesor · Thickness · Épaisseur · Dimensione  
200 g/m<sup>2</sup>



ACERO INOXIDABLE · STAINLESS STEEL · ACIER INOXIDABLE · ACCIAIO INOX

MADERA · WOOD · BOIS · LEGNO

Losa de hormigón obligatorio · Obligatory concrete slab · Chape béton Obligatoire · Basamento di calcestruzzo obbligatorio

1300 x 500 x H 17 cm  
11,05 m<sup>3</sup>

1100 x 500 x H 17 cm  
9,35 m<sup>3</sup>

1000 x 400 x H 17 cm  
6,8 m<sup>3</sup>

L 400 x l 120 x H 94 cm - 2100 kg  
L 80 x l 200 x H 100 cm - 300 kg

L 400 x l 120 x H 84 cm - 1800 kg  
L 200 x l 80 x H 100 cm - 300 kg

L 300 x l 80 x H 120 cm - 1500 kg  
L 200 x l 80 x H 100 cm - 300 kg

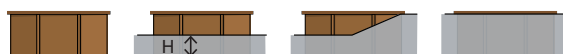

wooden pool

# BRAGA · EVORA · MARBELLA

H. 1,46 m - H. 1,33 m - H. 1,19 m



	REFERENCIA RÉFERENCE	REFERENCE RIFERIMENTO
	CÓDIGO EAN GENCOD	EAN CODE CODICE A BARRE
	EXTERIORES EXTÉRIEURES	OUTSIDE ESTERNO
	INTERIORES INTÉRIEURES	INSIDE INTERNI
	VOLUMEN DE AGUA VOLUME D'EAU	WATER VOLUME VOLUME DI ACQUA
	PANELES PANS	PANELS PANNELLI
	LINEA DE AGUA LIGNE D'EAU	WATER LINE LINEA DELL'ACQUA
	ESTRUCTURA STRUCTURE	STRUCTURE STRUTTURA
	PLAYAS MARGELLES	EDGES BORDI
	ESPESOR MADERA ÉPAISEUR MADRIER	WOOD THICKNESS DIMENSIONE
	LINER	
	FILTRACIÓN FILTRATION	FILTRATION FILTRO
	PROTECTOR DE FONDO FEUTRE DE FOND	FLOOR PROTECTOR PROTEZIONE DEL FONDO
	PROTECTOR DE PARED FEUTRE DE PAROI	WALL PROTECTOR COPERTURA DELLA PARETE
	ESCALERA INTERIOR ÉCHELLE INTÉRIEURE	INSIDE LADDER SCALA INTERNA
	ESCALERA EXTERIOR ÉCHELLE EXTÉRIEURE	OUTSIDE LADDER SCALA ESTERNA
	TERRENO SUPPORT	LAND TERRENO
	PALET	
	IMPLANTATION	



## BRAGA



## EVORA



## MARBELLA

OMEGA  
SYSTEM**790095**LDD: **790095D**

3605217900951

LDD: 8412081003375

8,00 x 4,00 x H. 1,46 m

7,52 x 3,52 x H. 1,42 m

37 m<sup>3</sup>

4

1,34 m

**790094**LDD: **790094D**

3605217900883

LDD: 8412081003306

6,00 x 4,00 x H. 1,33 m

5,52 x 3,52 x H. 1,30 m

23,5 m<sup>3</sup>

4

1,20 m

**790096**LDD: **790096D**

3605217900968

LDD: 8412081003382

4,00 x 2,50 x H. 1,19 m

3,79 x 2,29 x H. 1,16 m

10 m<sup>3</sup>

4

1,06 m

Pino silvestre francés y autoclave clase IV · Pine boards originating in France, with a class IV autoclave · Pin sylvestre origine France autoclave classe IV · pino silvestre francese con trattamento in autoclave classe IV - Certificado · Certificate · Certifié · Certificato **PEFC**Ancho · Width · Largeur · Larghezza: 29 cm · Espesor · Thickness · Épaisseur · Dimensione: 2,8 cm, BRAGA: 3,6 cm  
Embellecedores metálicos · Metal covers · Caches angles inox · Protezione metallico inox

46 mm

46 mm

46 mm

75/100<sup>e</sup> uni75/100<sup>e</sup> uni75/100<sup>e</sup> uni

FILTRO DE ARENA · SAND FILTER · FILTRATION À SABLE · FILTRO A SABBIA

12 m<sup>3</sup> /h - 2 skimmer8 m<sup>3</sup>/h - 2 skimmer6 m<sup>3</sup>/hEspesor · Thickness · Épaisseur · Dimensione  
200 g/m<sup>2</sup>

ACERO INOXIDABLE · STAINLESS STEEL · ACIER INOXIDABLE · ACCIAIO INOX

MADERA · WOOD · BOIS · LEGNO

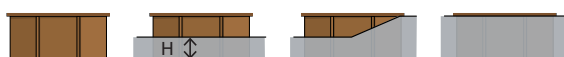
Losa de hormigón obligatorio · Obligatory concrete slab · Chape béton Obligatoire · Basamento di calcestruzzo obbligatorio  
\*Marbella: Losa de hormigón opcional · Optional concrete slab · Chape béton facultative · Basamento di calcestruzzo opzionale900 x 500 x H 17 cm  
7,65 m<sup>3</sup>700 x 500 x H 17 cm  
5,95 m<sup>3</sup>500 x 350 x H 15 cm  
2,62 m<sup>3</sup>L 500 x l 120 x H 63,5 cm - 1500kg  
L 200 x l 80 x H 100 cm - 120 kgL 573 x l 120 x H 46 cm - 1200 kg  
L 80 x l 120 x H 100 cm - 300 kgL 400 x l 120 x H 40 cm - 700 kg  
L 80 x l 200 x H 100 cm - 120 kg

wooden pool

# CARRA · CITY

H. 1,19 m - H. 0,68 m



REFERENCIA RÉFERENCE	REFERENCE RIFERIMENTO
 CÓDIGO EAN GENCOD	EAN CODE CODICE A BARRE
 EXTERIORES EXTÉRIEURES	OUTSIDE ESTERNO
 INTERIORES INTÉRIEURES	INSIDE INTERNI
 VOLUMEN DE AGUA VOLUME D'EAU	WATER VOLUME VOLUME DI ACQUA
 PANELES PANS	PANELS PANNELLI
 LINEA DE AGUA LIGNE D'EAU	WATER LINE LINEA DELL'ACQUA
 ESTRUCTURA STRUCTURE	STRUCTURE STRUTTURA
 PLAYAS MARGELLES	EDGES BORDI
 ESPESOR MADERA ÉPAISEUR MADRIER	WOOD THICKNESS DIMENSIONE
 LINER	
 FILTRACIÓN FILTRATION	FILTRATION FILTRO
 PROTECTOR DE FONDO FEUTRE DE FOND	FLOOR PROTECTOR PROTEZIONE DEL FONDO
 PROTECTOR DE PARED FEUTRE DE PAROI	WALL PROTECTOR COPERTURA DELLA PARETE
 ESCALERA INTERIOR ÉCHELLE INTÉRIEURE	INSIDE LADDER SCALA INTERNA
 ESCALERA EXTERIOR ÉCHELLE EXTÉRIEURE	OUTSIDE LADDER SCALA ESTERNA
 TERRENO SUPPORT	LAND TERRENO
 PALET	
 IMPLANTATION	



<b>790093</b>	<b>790000</b>
 LDD: <b>790093D</b>	LDD: <b>790000D</b>
3605217900937	3605217900005
LDD: 8412081003351	LDD: 8412081003474
3,00 x 3,00 x H. 1,19 m	2,25 x 2,25 x H. 0,68 m
2,67 x 2,67 x H. 1,16 m	2,00 x 2,00 x H. 0,65 m
<b>7,6 m<sup>3</sup></b>	<b>2,3 m<sup>3</sup></b>
<b>4</b>	<b>4</b>
1,06 m	0,55 m
Pino silvestre francés y autoclave clase IV · Pine boards originating in France, with a class IV autoclave · Pin sylvestre origine France autoclave classe IV · pino silvestre francese con trattamento in autoclave classe IV - Certificado · Certificate · Certifié · Certificato <b>PEFC</b>	
Ancho · Width · Largeur · Larghezza: 19 cm · Espesor · Thickness · Épaisseur · Dimensione: 2,8 cm Embellecedores metálicos · Metal covers · Caches angles inox · Protezione metallico inox	
46 mm	46 mm
60/100 <sup>e</sup> uni	50/100 <sup>e</sup> uni
FILTRO DE ARENA · SAND FILTER · FILTRATION À SABLE · FILTRO A SABBIA	FILTRO DE CARTUCHO · CARTRIDGE FILTER · EPURATEUR À CARTOUCHE · FILTRO A CARTUCCIA
4 m <sup>3</sup> /h	2 m <sup>3</sup> /h
Espesor · Thickness · Épaisseur · Dimensione 200 g/m <sup>2</sup>	
✓	-
ACERO INOXIDABLE · STAINLESS STEEL · ACIER INOXIDABLE ACCIAIO INOX	-
MADERA · WOOD · BOIS · LEGNO	-
Losa de hormigón obligatorio · Obligatory concrete slab · Chape béton Obligatoire · Basamento di calcestruzzo obbligatorio	Losa de hormigón opcional · Optional concrete slab · Chape béton facultative · Basamento di calcestruzzo opzionale
400 x 400 x H 15 cm <b>2,4 m<sup>3</sup></b>	350 x 350 x H 15 cm <b>1,8 m<sup>3</sup></b>
L 300 x l 120 x H 40 cm - 550 kg L 80 x l 120 x H 78 cm - 100 kg	L 200 x l 120 x H 60 cm - 700 kg

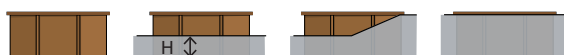



# Avantgarde <sup>POOLS</sup>

## PISCINAS DE COMPOSITE

**LINER:** Tratamiento Anti-ultravioleta que retrasa el envejecimiento del P.V.C

**COMPOSITE:** Las piscinas de composite están fabricadas de un nuevo material mezcla de madera (harina de madera) y polímeros.

## PISCINES COMPOSITE

**LINER:** Traitement anti-ultraviolets contre le vieillissement du P.V.C.

**COMPOSITE:** Les piscines "composite" sont fabriquées avec un nouveau matériau composé d'un mélange de bois (farine de bois) et de polymères.

## COMPOSITE POOLS

**LINER:** Anti-ultraviolet treatment to slow down P.V.C aging.

**COMPOSITE:** Composite pools are made of a new material mix of wood (wood flour) and polymers.

## PISCINA IN COMPOSITE

**LINER:** Trattamento Anti-ultravioletti - Ritarda l'invecchiamento del P.V.C.

**COMPOSITE:** Le piscine in composite vengono prodotte con un nuovo materiale composto da una miscela di legno (farina di legno) e polimeri.



Resina plástica  
Plastic resin  
Résine plastique  
Resina plastica



Serrín  
Sawdust  
Farine de bois  
Segatura



Pigmento  
Pigments  
Pigments  
Pigmenti



Aditivos con carga mineral  
Mineral additives  
Additifs Charge minérale  
Additivi con carica minerale



DESIGNED &  
ASSEMBLED  
IN EU

# composite pool



KPCOR60

NEW



EAN 13

	Pool Dimensions	Water Level	Capacity	Weight	Box Size	Pump	Ladder	Cover	Barcode
KPCOR60	606x326 cm	124 cm	17.875 l	1220 kg	1/170x130	6m <sup>3</sup> /h	✓	✓	8 412081 273686
<b>NEW</b> KPCOR28	326x326 cm	96 cm	6.600 l	900 kg	1/170x130	4m <sup>3</sup> /h	✓	✓	

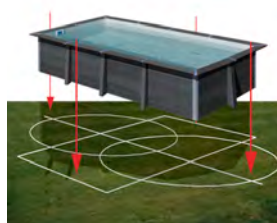

MEDIDA PISCINA  
POOL SIZE  
DIMENSIONS PISCINE  
MISURA PISCINA

ESPACIO NECESARIO  
NECESSARY SPACE  
ESPACE NECESSAIRE  
SPAZIO NECESSARIO

KPCOR60

606x326 cm

806x526 cm

KPCOR28

326x326 cm

526x526 cm

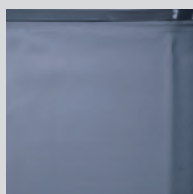

Liner PVC gris  
60/100  
PVC grey liner  
60/100  
Liner PVC gris  
60/100  
Liner PVC grigio  
60/100

NEW

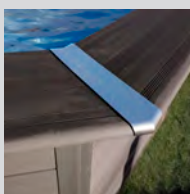

Embellecedores de  
aluminio  
Aluminium trims  
Protections en  
aluminium  
Profili in  
alluminio

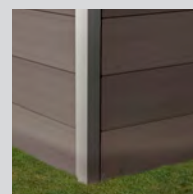

Perfileria de acero  
Steel profiles  
Poteaux et margelles  
acier  
Profili in acciaio



La cuña metálica se fija sobre la losa de cemento. Así, es necesario realizar la losa, de 15cm de espesor mínimo, previamente al montaje de la piscina.

The wedge is fixed over the concrete slab. In such a way, it is possible to make the slab, of 15cm minimum, beforehand to the assembly of the pool.

Le sabot vient se fixer sur la dalle en béton. Il est donc possible de réaliser la dalle, épaisseur 15 cm minimum, préalablement au montage du bassin.

Il cuneo metallico si fissa sopra il massetto di cemento. Quindi è necessario realizzare il massetto dello spessore minimo di 15cm prima del montaggio della piscina.

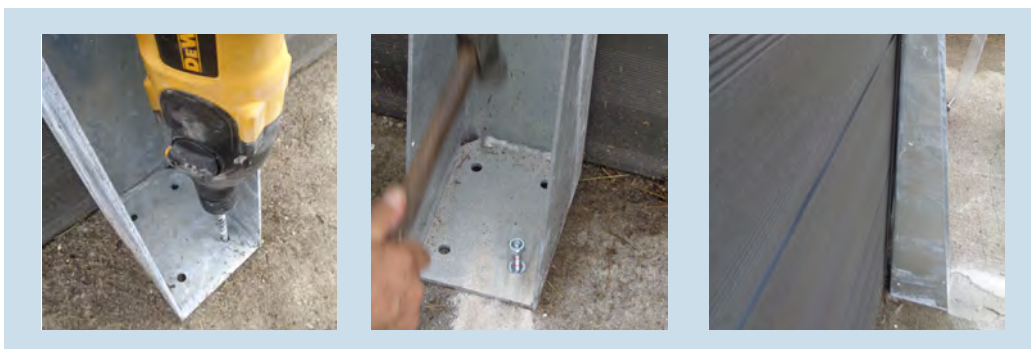

Cuña metálica Metallic wedge Sabots Cuneo metallico



Depuradora arena  
(Caudal grupo 6/4 m<sup>3</sup>/h)  
Sand filter  
(Flow group 6/4 m<sup>3</sup>/h)  
Filtre à sable  
(Débit groupe 6/4 m<sup>3</sup>/h)  
Filtro a sabbia  
(Portata gruppo 6/4 m<sup>3</sup>/h)



Escalera:  
- Composite / acero inoxidable  
Ladder:  
- Composite / stainless steel  
Échelle:  
- Composite / acier inoxydable  
Scale:  
- Composite / acciaio inox

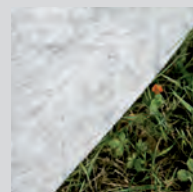

Manta protectora  
(Poliéster)  
Bottom protectiveblanket  
(Polyester)  
Tapis de sol en feutre  
(Polyester)  
Telo di protezione  
(Poliestere)

# composite pool



KPCOV52



Vigas enterradas de 15x15 cm que hace innecesarios los postes exteriores, obteniendo mejor aprovechamiento del jardín.

15x15cm buried steel beam makes unnecessary the outer posts, optimizing the use of the garden area.

Poteaux en acier à enterrer de 15x15 cm évitant des renforts apparents extérieurs, pour mieux profiter de l'espace du jardin.

Barra di acciaio interrata da 15x15 cm che non rende necessario l'utilizzo delle barre laterali; permette di poter sfruttare al meglio gli spazi del proprio giardino.



EAN 13

	804x386 cm	664x386 cm	524x386 cm
KPCOV80	804x386 cm	664x386 cm	524x386 cm
KPCOV66	124 cm	124 cm	124 cm
KPCOV52	27.000 l	21.500 l	16.210 l
	1450 kg	1220 kg	960 kg
	1/170x150	1/170x150	1/170x130
	6m <sup>3</sup> /h	6m <sup>3</sup> /h	6m <sup>3</sup> /h
	√	√	√
	√	√	√
	8 412081 268804	8 412081 268798	8 412081 268781

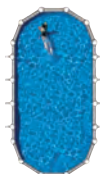
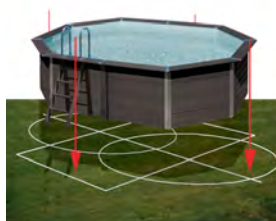

MEDIDA PISCINA  
POOL SIZE  
DIMENSIONS PISCINE  
MISURA PISCINA

ESPACIO NECESARIO  
NECESSARY SPACE  
ESPACE NECESSAIRE  
SPAZIO NECESSARIO

KPCOV80	804x386 cm	844x506 cm
KPCOV66	664x386 cm	704x506 cm
KPCOV52	524x386 cm	564x506 cm

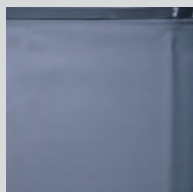

**NEW**  
Liner PVC gris  
60/100  
PVC grey liner  
60/100  
Liner PVC gris  
60/100  
Liner PVC grigio  
60/100

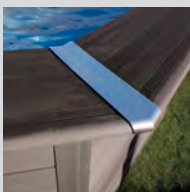

Embellecedores de  
aluminio  
Aluminium trims  
Protections en  
aluminium  
Profili in  
alluminio

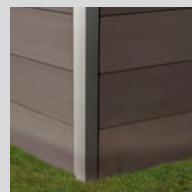

Perfileria de acero  
Steel profiles  
Poteaux et mangelles  
acier  
Profili in acciaio





KPC041



EAN 13

KPC041

Ø 410 cm

124 cm

11.000 l

705 kg

1/170x130

4m<sup>3</sup>/h

√

√



8 412081 268774

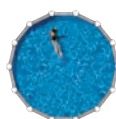

MEDIDA PISCINA  
POOL SIZE  
DIMENSIONS PISCINE  
MISURA PISCINA

ESPACIO NECESARIO  
NECESSARY SPACE  
ESPACE NECESSAIRE  
SPAZIO NECESSARIO

KPC041

Ø 410cm

450x450 cm



Depuradora arena  
(Caudal grupo 6/4 m<sup>3</sup>/h)  
Sand filter  
(Flow group 6/4 m<sup>3</sup>/h)  
Filtre à sable  
(Débit groupe 6/4 m<sup>3</sup>/h)  
Filtro a sabbia  
Portata gruppo 6/4 m<sup>3</sup>/h

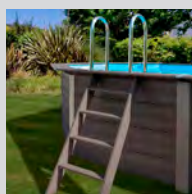

Escalera:  
- Composite / acero inoxidable  
Ladder:  
- Composite / stainless steel  
Échelle:  
- Composite / acier inoxydable  
Scale:  
- Composite / acciaio inox

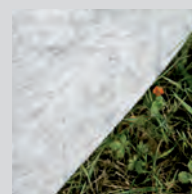

Manta protectora  
(Poliéster)  
Bottom protectiveblanket  
(Polyester)  
Tapis de sol en feutre  
(Polyester)  
Telo di protezione  
(Poliestere)





## PISCINA DE PARED DE ACERO CON PERFLERÍA DE POLIPROPILENO

**LINER:** Tratamiento Anti - Ultravioleta que retrasa el envejecimiento del P.V.C.

**PARED:** laminada en frío con tratamiento de galvanización, fosfatación, imprimación y lacado.

Perfilación vertical de la misma para la obtención de una mayor resistencia.

Troquelada para skimmer y válvula de retorno del agua.

**PIEZAS ESTRUCTURALES:** De acero.

**PERFILES Y PLAYAS:** Polipropileno

## PISCINE PAROI ACIER AVEC STRUCTURE DE POLYPROPYLÈNE

**LINER:** Traitement anti-ultraviolets contre le vieillissement du P.V.C.

**PAROI:** Tôle laminée à froid et traitée par galvanisation, phosphatage, couche d'apprêt et laquage.

Profils verticaux pour une meilleure résistance.

Découpage pour le skimmer et la buse de refoulement.

**PIÈCES STRUCTURELLES::** Métalliques

**STRUCTURES ET MARGELLES:** Polypropylène



## STEEL WALL POOL WITH POLYPROPYLENE PROFILES

**LINER:** Anti-ultraviolet treatment to slow down P.V.C aging.

**WALL:** Galvanized, phosphatized, primed and lacquered cold-rolled plate .

Vertical sectioning for an increased strength . Die cut for skimmer and water return valve openings.

**STRUCTURAL PARTS:** Steel

**PROFILES AND EDGES:** Polypropylene

## PISCINA CON PARETI IN ACCIAIO CON PROFILI DI POLIPROPILENE

**LINER:** Trattamento Anti-ultravioletti - Ritarda l'invecchiamento del P.V.C.

**PARETE:** Laminata a freddo con trattamento di galvanizzazione, fosfatazione e preparazione.

Preparazione verticale per ottenere una maggiore resistenza.

Stampigliatura per Skimmer e valvola di ritorno dell'acqua.

**PEZZI STRUTTURALI:** Acciaio.

**PROFILI ED PROFILI SUPERIORI:** Polipropilene



# Fusion pool

Viga de acero enterrada 5cm  
Ver manual de instrucciones  
5cm buried steel beam  
See instruction manual  
Poteaux en acier à enterrer 5cm  
Consulter les instructions  
Barra di acciaio interrata 5cm  
Consultare le istruzioni

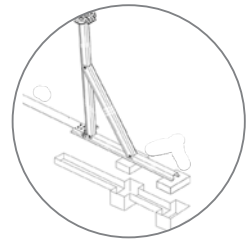

KITPROV760H



EAN 13

	760x460 cm	670x370 cm	520x370 cm
KITPROV760H	760x460 cm	670x370 cm	520x370 cm
	135 cm	135 cm	135 cm
	35.200 l	25.200 l	18.700 l
	375 kg	315 kg	295 kg
	1/120x80	1/120x80	1/120x80
	7m <sup>3</sup> /h	5m <sup>3</sup> /h	5m <sup>3</sup> /h
	√	√	√
	√	√	√
	8 412081 273556	8 412081 273563	8 412081 273570

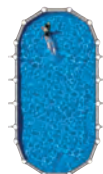
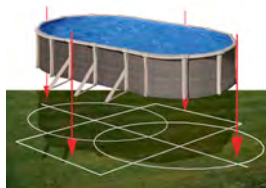

MEDIDA PISCINA  
POOL SIZE  
DIMENSIONS PISCINE  
MISURA PISCINA

ESPACIO NECESARIO  
NECESSARY SPACE  
ESPACE NECESSAIRE  
SPAZIO NECESSARIO

KITPROV760H	760x460 cm	860x660 cm
KITPROV670H	670x370 cm	770x570 cm
KITPROV520H	520x370 cm	620x570 cm



Liner PVC azul  
40/100  
PVC blue liner  
40/100  
Liner PVC bleu  
40/100  
Liner PVC blu  
40/100

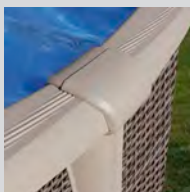

Embellecedores de  
Polipropileno  
Polypropylene trims  
Protections en  
polypropylène  
Profili in  
polipropilene

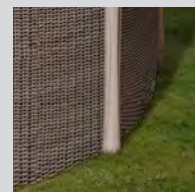

Perfilería de  
Polipropileno  
Polypropylene  
profiles  
Poteaux et marges  
polypropylène  
Profili in polipropilene

KITPR460H



EAN 13

KITPR460H

Ø 460 cm

135 cm

19.200 l

237,5 kg

1/90x80

5m<sup>3</sup>/h

√

√

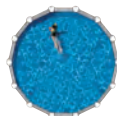
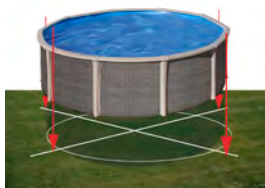

MEDIDA PISCINA  
POOL SIZE  
DIMENSIONS PISCINE  
MISURA PISCINA

ESPACIO NECESARIO  
NECESSARY SPACE  
ESPACE NECESSAIRE  
SPAZIO NECESSARIO

KITPR460H

Ø 460 cm

500x500 cm



Depuradora arena  
(Caudal grupo 7/5 m<sup>3</sup>/h)  
Sand filter  
(Flow group 7/5 m<sup>3</sup>/h)  
Filtre à sable  
(Débit groupe 7/5 m<sup>3</sup>/h)  
Filtro a sabbia  
(Portata gruppo 7/5 m<sup>3</sup>/h)

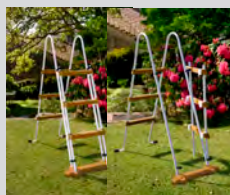

Escalera de seguridad  
2x3 Peldaños  
Safety Ladder  
2x3 Steps  
Échelle sécurité  
2x3 Marches  
Scala di sicurezza  
2x3 Gradini



Manta protectora  
(Poliéster)  
Bottom protectiveblanket  
(Polyester)  
Tapis de sol en feutre  
(Polyester)  
Telo di protezione  
(Poliestere)





## PISCINA DESMONTABLE DE PARED DE ACERO

**LINER:** Tratamiento Anti - Ultravioleta que retrasa el envejecimiento del P.V.C.

**CHAPA:** laminada en frío con tratamiento de galvanización, fosfatación, imprimación y lacado.

Perfilación vertical de la misma para la obtención de una mayor resistencia.

Troquelada para skimmer y válvula de retorno del agua.

**PIEZAS ESTRUCTURALES:** De acero.

## PISCINE HORS SOL PAROI ACIER

**LINER:** Traitement anti-ultraviolets contre le vieillissement du P.V.C.

**TÔLE:** Tôle laminée à froid et traitée par galvanisation, phosphatage, couche d'apprêt et laquage.

Profils verticaux pour une meilleure résistance.

Découpage pour le skimmer et la buse de refoulement.

**PIÈCES STRUCTURELLES:** Métalliques

## STEEL WALL POOL

**LINER:** Anti-ultraviolet treatment to slow down P.V.C aging.

**PLATE:** Galvanized, phosphatized, primed and lacquered cold-rolled plate .

Vertical sectioning for an increased strength . Die cut for skimmer and water return valve openings.

**STRUCTURAL PARTS:** Steel

## PISCINE FUORI TERRA CON PARETI IN ACCIAIO

**LINER:** Trattamento Anti-ultravioletti - Ritarda l'invecchiamento del P.V.C.

**PANNELLO:** Laminata a freddo con trattamento di galvanizzazione, fosfatazione e preparazione.

Preparazione verticale per ottenere una maggiore resistenza.

Stampigliatura per Skimmer e valvola di ritorno dell'acqua.

**PEZZI STRUTTURALI:** Acciaio.

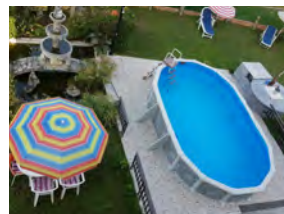
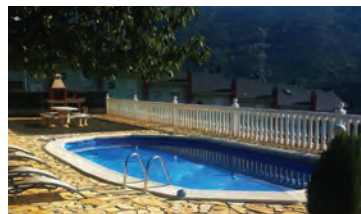

**MADE  
IN  
EU**

# dream pool serie **CAPRI**

KITPROV7388GF



EAN 13

KITPROV7388GF	730x375 cm	132 cm	28.217 l	348 kg	1/120x80	5m <sup>3</sup> /h	√	√	15	12	
KITPROV6188GF	610x375 cm	132 cm	23.281 l	279 kg	1/90x80	5m <sup>3</sup> /h	√	√	15	12	

🇫🇷 Références non disponibles en France

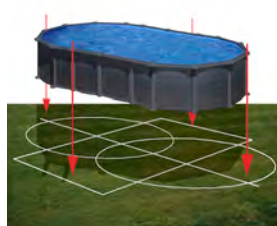

MEDIDA PISCINA  
POOL SIZE  
DIMENSIONS PISCINE  
MISURA PISCINA

ESPACIO NECESARIO  
NECESSARY SPACE  
ESPACE NECESSAIRE  
SPAZIO NECESSARIO

KITPROV7388GF	730x375 cm	770x495 cm
KITPROV6188GF	610x375 cm	650x495 cm



Liner PVC azul 40/100  
PVC blue liner 40/100  
Liner PVC bleu 40/100  
Liner PVC blu 40/100

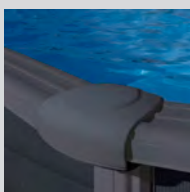

Protectores de inyección  
Injection saver  
Protections moulées par injection  
Angolare di protezione

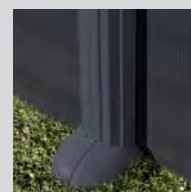

Perfileria de acero  
Steel profiles  
Poteaux et margelles acier  
Profili in acciaio



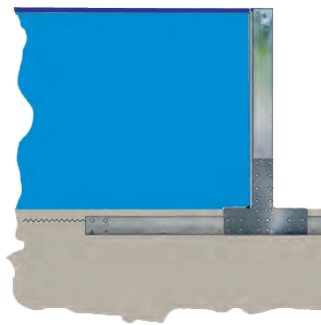

Viga de acero enterrada de 15x15 cm que hace innecesarios los postes exteriores, obteniendo mejor aprovechamiento del jardín.

15x15 cm buried steel beam makes unnecessary the outer buttress, optimizing the use of the garden area.

Poteaux en acier à enterrer de 15x15 cm évitant des renforts apparents extérieurs, pour mieux profiter de l'espace du jardin.

Barra di acciaio interrata da 15x15 cm che non rende necessario l'utilizzo delle barre laterali; permette di poter sfruttare al meglio gli spazi del proprio giardino.



Sistema de omegas Omega system Renforts enterrés Sistema omega



Depuradora arena  
(Caudal grupo 5 m<sup>3</sup>/h)  
Sand filter  
(Flow group 5 m<sup>3</sup>/h)  
Filtre à sable  
(Débit groupe 5 m<sup>3</sup>/h)  
Filtro a sabbia  
(Portata gruppo 5 )m<sup>3</sup>/h



Escalera de seguridad  
Plataforma +2x3 Peldaños  
Safety Ladder  
Platform + 2x3 Steps  
Échelle sécurité  
Plateforme + 2x3 Marches  
Scala di sicurezza  
Piattaforma + 2x3 Gradini



Tapiz protector  
(Polietileno)  
Floor tapestry  
(Polythene)  
Tapis de sol en feutre  
(Polyéthylène)  
Telo di protezione  
(Polietilene)

# dream pool serie GRANADA

KITPROV738GF



EAN 13

	730x375 cm	132 cm	28.217 l	335 kg	1/120x80	5m <sup>3</sup> /h	√	√	15	12	
KITPROV738GF	730x375 cm	132 cm	28.217 l	335 kg	1/120x80	5m <sup>3</sup> /h	√	√	15	12	8 4 1 2 0 8 1 * 2 7 2 4 0 5
KITPROV618GF	610x375 cm	132 cm	23.281 l	270 kg	1/90x80	5m <sup>3</sup> /h	√	√	15	12	8 4 1 2 0 8 1 * 2 7 2 4 1 2
KITPROV508GF	500x300 cm	132 cm	16.210 l	260 kg	1/90x80	5m <sup>3</sup> /h	√	√	15	12	8 4 1 2 0 8 1 * 2 7 2 4 2 9

🇫🇷 Références non disponibles en France



MEDIDA PISCINA  
POOL SIZE  
DIMENSIONS PISCINE  
MISURA PISCINA

ESPACIO NECESARIO  
NECESSARY SPACE  
ESPACE NECESSAIRE  
SPAZIO NECESSARIO

KITPROV738GF	730x375 cm	770x595 cm
KITPROV618GF	610x375 cm	650x595 cm
KITPROV508GF	500x300 cm	540x520 cm



Liner PVC azul  
40/100  
PVC blue liner  
40/100  
Liner PVC bleu  
40/100  
Liner PVC blu  
40/100

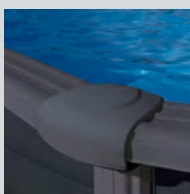

Protectores de  
inyección  
Injection saver  
Protections moulées  
par injection  
Angolare di  
protezione

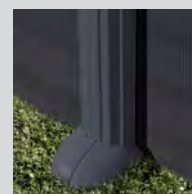

Perfileria de acero  
Steel profiles  
Poteaux et mangelles  
acier  
Profili in acciaio

KITPR558GF



EAN 13

Model	Ø	Height	Volume	Weight	Box Size	Flow	Filter	Ladder	Mat	Tapestry	Barcode
KITPR558GF	Ø550 cm	132 cm	27.798 l	243 kg	1/90x80	5m³/h	√	√	15	12	8 4 1 2 0 8 1 * 2 7 2 4 3 6
KITPR458GF	Ø460 cm	132 cm	19.444 l	238 kg	1/90x80	5m³/h	√	√	15	12	8 4 1 2 0 8 1 * 2 7 2 4 4 3
KITPR358GF	Ø350 cm	132 cm	11.250 l	184 kg	1/90x80	5m³/h	√	√	15	12	8 4 1 2 0 8 1 * 2 7 2 4 5 0

🇫🇷 Références non disponibles en France

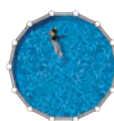
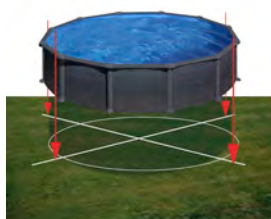

MEDIDA PISCINA  
POOL SIZE  
DIMENSIONS PISCINE  
MISURA PISCINA

ESPACIO NECESARIO  
NECESSARY SPACE  
ESPACE NECESSAIRE  
SPAZIO NECESSARIO

KITPR558GF	Ø 550cm	600x600 cm
KITPR458GF	Ø 460cm	500x500 cm
KITPR358GF	Ø 350cm	400x400 cm



Depuradora arena  
(Caudal grupo 5 m³/h)  
Sand filter  
(Flow group 5 m³/h)  
Filtre à sable  
(Débit groupe 5 m³/h)  
Filtro a sabbia  
(Portata gruppo 5 m³/h)



Escalera de seguridad  
Plataforma +2x3 Peldaños  
Safety Ladder  
Platform + 2x3 Steps  
Échelle sécurité  
Plateforme + 2x3 Marches  
Scala di sicurezza  
Piattaforma + 2x3 Gradini



Tapiz protector  
(Polietileno)  
Floor tapestry  
(Polythene)  
Tapis de sol en feutre  
(Polyéthylène)  
Telo di protezione  
(Polietilene)

# dream pool serie KEA

KIT610GF



EAN 13

	730x375 cm	610x375 cm	500x300 cm
KIT730GF	730x375 cm	610x375 cm	500x300 cm
KIT610GF	120 cm	120 cm	120 cm
KIT500GF	25.323 l	20.893 l	14.550 l
	287 kg	235 kg	224 kg
	1/90x80	1/80x60	1/80x60
	4m³/h	3m³/h	3m³/h
	√	√	√
	15	15	15
	12	12	12
	8 4 1 2 0 8 1 2 7 2 4 6 7	8 4 1 2 0 8 1 2 7 2 4 7 4	8 4 1 2 0 8 1 2 7 3 0 8 2

**Références non disponibles en France**

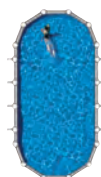

MEDIDA PISCINA  
POOL SIZE  
DIMENSIONS PISCINE  
MISURA PISCINA

ESPACIO NECESARIO  
NECESSARY SPACE  
ESPACE NECESSAIRE  
SPAZIO NECESSARIO

KIT730GF	730x375 cm	770x595 cm
KIT610GF	610x375 cm	650x595 cm
KIT500GF	500x300 cm	540x520 cm



Liner PVC azul  
40/100  
PVC blue liner  
40/100  
Liner PVC bleu  
40/100  
Liner PVC blu  
40/100  
KIT500/460/350GF: 30/100

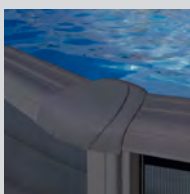

Protectores de  
inyección  
Injection saver  
Protections moulées  
par injection  
Angolare di  
protezione

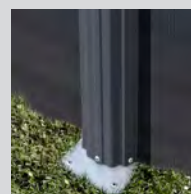



Perfileria de acero  
Steel profiles  
Poteaux et margelles  
acier  
Profili in acciaio



KIT350GF



EAN 13

KIT460GF	Ø460 cm	120 cm	17.450 l	172 kg	1/80x60	3m³/h	√	15	12	
KIT350GF	Ø350 cm	120 cm	10.102 l	146 kg	1/80x60	3m³/h	√	15	12	
<b>NEW</b> KIT240GF	Ø240 cm	120 cm	4.750 l	126 kg	1/80x60	3m³/h	√	15	12	

 Références non disponibles en France

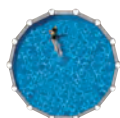
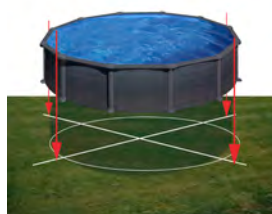

	MEDIDA PISCINA POOL SIZE DIMENSIONS PISCINE MISURA PISCINA	ESPACIO NECESARIO NECESSARY SPACE ESPACE NECESSAIRE SPAZIO NECESSARIO
KIT460GF	Ø 460cm	500x500 cm
KIT350GF	Ø 350cm	400x400 cm
KIT240GF	Ø 240cm	300x300 cm



Depuradora arena  
(Caudal grupo 3/4 m³/h)  
Sand filter  
(Flow group 3/4 m³/h)  
Filtre à sable  
(Débit groupe 3/4 m³/h)  
Filtro a sabbia  
(Portata gruppo 3/4 m³/h)

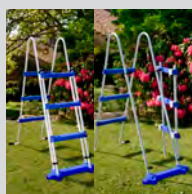

Escalera de seguridad  
2x3 Peldaños  
Safety Ladder  
2x3 Steps  
Échelle sécurité  
2x3 Marches  
Scala di sicurezza  
2x3 Gradini

dream pool serie

# SANTORINI

KITPROV7388PO



EAN 13

KITPROV7388PO	730x375 cm	132 cm	28.217 l	348 kg	1/120x80	5m <sup>3</sup> /h	√	√	15	12	
KITPROV6188PO	610x375 cm	132 cm	23.281 l	279 kg	1/90x80	5m <sup>3</sup> /h	√	√	15	12	

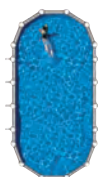
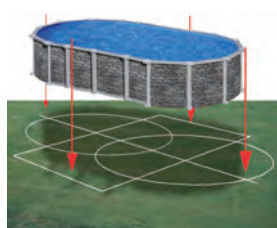

MEDIDA PISCINA  
POOL SIZE  
DIMENSIONS PISCINE  
MISURA PISCINA

ESPACIO NECESARIO  
NECESSARY SPACE  
ESPACE NECESSAIRE  
SPAZIO NECESSARIO

KITPROV7388P

730x375 cm

770x495 cm

KITPROV6188P

610x375 cm

650x495 cm



Liner PVC azul  
40/100  
PVC blue liner  
40/100  
Liner PVC bleu  
40/100  
Liner PVC blu  
40/100



Protectores de  
inyección  
Injection saver  
Protections moulées  
par injection  
Angolare di  
protezione



Perfilería de acero  
Steel profiles  
Poteaux et margelles  
acier  
Profili in acciaio

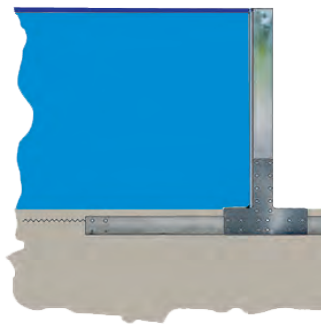

Viga de acero enterrada de 15x15 cm que hace innecesarios los postes exteriores, obteniendo mejor aprovechamiento del jardín.

15x15 cm buried steel beam makes unnecessary the outer buttress, optimizing the use of the garden area.

Poteaux en acier à enterrer de 15x15 cm évitant des renforts apparents extérieurs, pour mieux profiter de l'espace du jardin.

Barra di acciaio interrata da 15x15 cm che non rende necessario l'utilizzo delle barre laterali; permette di poter sfruttare al meglio gli spazi del proprio giardino.



Sistema de omegas Omega system Renforts enterrés Sistema omega



Depuradora arena  
(Caudal grupo 5 m<sup>3</sup>/h)  
Sand filter  
(Flow group 5 m<sup>3</sup>/h)  
Filtre à sable  
(Débit groupe 5 m<sup>3</sup>/h)  
Filtro a sabbia  
(Portata gruppo 5 m<sup>3</sup>/h)



Escalera de seguridad  
Plataforma +2x3 Peldaños  
Safety Ladder  
Platform + 2x3 Steps  
Échelle sécurité  
Plateforme + 2x3 Marches  
Scala di sicurezza  
Piattaforma + 2x3 Gradini



Tapiz protector  
(Polietileno)  
Floor tapestry  
(Polythene)  
Tapis de sol en feutre  
(Polyéthylène)  
Telo di protezione  
(Polietilene)

# dream pool serie CÓRCEGA



KITPROV618PO



EAN 13

Model	Dimensions (cm)	Height (cm)	Capacity (l)	Weight (kg)	Box Size (cm)	Flow (m³/h)	Filter	Ladder	Cover	Liner	EAN 13
KITPROV738PO	730x375	132	28.217	335	1/120x80	5m³/h	√	√	15	12	8 412081 264516
KITPROV618PO	610x375	132	23.281	270	1/90x80	5m³/h	√	√	15	12	8 412081 264523
KITPROV508PO	500x300	132	16.210	260	1/90x80	5m³/h	√	√	15	12	8 412081 264547

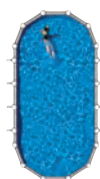
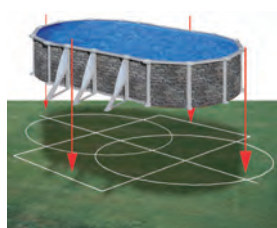

MEDIDA PISCINA  
POOL SIZE  
DIMENSIONS PISCINE  
MISURA PISCINA

ESPACIO NECESARIO  
NECESSARY SPACE  
ESPACE NECESSAIRE  
SPAZIO NECESSARIO

Model	Pool Size (cm)	Necessary Space (cm)
KITPROV738PO	730x375	770x595
KITPROV618PO	610x375	650x595
KITPROV508PO	500x300	540x520



Liner PVC azul  
40/100  
PVC blue liner  
40/100  
Liner PVC bleu  
40/100  
Liner PVC blu  
40/100



Protectores de  
inyección  
Injection saver  
Protections moulées  
par injection  
Angolare di  
protezione



Perfilería de acero  
Steel profiles  
Poteaux et margelles  
acier  
Profili in acciaio





KITPR558PO



EAN 13

Model	Ø	Height	Volume	Weight	Box Size	Flow	✓	✓	Steps	Height	Barcode
KITPR558PO	Ø550 cm	132 cm	27.798 l	243 kg	1/90x80	5m <sup>3</sup> /h	√	√	15	12	8 4 1 2 0 8 1 2 6 4 5 3 0
KITPR458PO	Ø460 cm	132 cm	19.444 l	238 kg	1/90x80	5m <sup>3</sup> /h	√	√	15	12	8 4 1 2 0 8 1 2 6 4 5 5 4
KITPR358PO	Ø350 cm	132 cm	11.250 l	184 kg	1/90x80	5m <sup>3</sup> /h	√	√	15	12	8 4 1 2 0 8 1 2 6 4 5 6 1

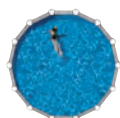

MEDIDA PISCINA  
POOL SIZE  
DIMENSIONS PISCINE  
MISURA PISCINA

ESPACIO NECESARIO  
NECESSARY SPACE  
ESPACE NECESSAIRE  
SPAZIO NECESSARIO

Model	Ø	Required Space
KITPR558PO	Ø 550cm	600x600 cm
KITPR458PO	Ø 460cm	500x500 cm
KITPR358PO	Ø 350cm	400x400 cm



Depuradora arena  
(Caudal grupo 5 m<sup>3</sup>/h)  
Sand filter  
(Flow group 5 m<sup>3</sup>/h)  
Filtre à sable  
(Débit groupe 5 m<sup>3</sup>/h)  
Filtro a sabbia  
(Portata gruppo 5 m<sup>3</sup>/h)



Escalera de seguridad  
Plataforma +2x3 Peldaños  
Safety Ladder  
Platform + 2x3 Steps  
Échelle sécurité  
Plateforme + 2x3 Marches  
Scala di sicurezza  
Piattaforma + 2x3 Gradini



Tapiz protector  
(Polietileno)  
Floor tapestry  
(Polythene)  
Tapis de sol en feutre  
(Polyéthylène)  
Telo di protezione  
(Polietilene)

# dream pool serie CERDEÑA



KIT610PO



EAN 13

Model	Dimensions (cm)	Depth (cm)	Volume (l)	Weight (kg)	Box Size (cm)	Flow Rate (m³/h)	Accessories	Height (cm)	Width (cm)	Barcode
KIT730PO	730x375	120	25.323	287	1/90x80	4m³/h	√	15	12	8 4 120 8 1 264 57 8
KIT610PO	610x375	120	20.893	235	1/80x60	3m³/h	√	15	12	8 4 120 8 1 264 58 5
KIT500PO	500x300	120	14.550	224	1/80x60	3m³/h	√	15	12	8 4 120 8 1 264 59 2

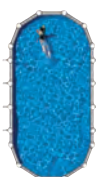
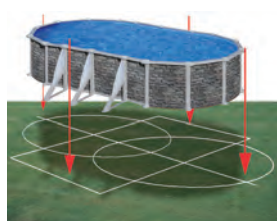

MEDIDA PISCINA  
POOL SIZE  
DIMENSIONS PISCINE  
MISURA PISCINA

ESPACIO NECESARIO  
NECESSARY SPACE  
ESPACE NECESSAIRE  
SPAZIO NECESSARIO

KIT730PO	730x375 cm	770x595 cm
KIT610PO	610x375 cm	650x595 cm
KIT500PO	500x300 cm	540x520 cm



Liner PVC azul 30/100  
KIT730P/KIT610P: 40/100  
PVC blue liner 30/100  
KIT730P/KIT610P: 40/100  
Liner PVC bleu 30/100  
KIT730P/KIT610P: 40/100  
Liner PVC blu 30/100  
KIT730P/KIT610P: 40/100



Protectores de inyección  
Injection saver  
Iniezione salvate  
Protections moulées par injection  
Angolare di protezione

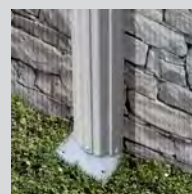

Perfileria de acero  
Steel profiles  
Poteaux et margelles acier  
Profili in acciaio



KIT350PO



EAN 13

	Ø	H	V	P	P	F	✓	P	P	Barcode
KIT460PO	Ø460 cm	120 cm	17.450 l	172 kg	1/80x60	3m <sup>3</sup> /h	✓	15	12	8 412081 264608
KIT350PO	Ø350 cm	120 cm	10.102 l	146 kg	1/80x60	3m <sup>3</sup> /h	✓	15	12	8 412081 264615
KIT240PO	Ø240 cm	120 cm	4.750 l	126 kg	1/80x60	3m <sup>3</sup> /h	✓	15	12	8 412081 264622

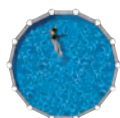

MEDIDA PISCINA  
POOL SIZE  
DIMENSIONS PISCINE  
MISURA PISCINA

ESPACIO NECESARIO  
NECESSARY SPACE  
ESPACE NECESSAIRE  
SPAZIO NECESSARIO

KIT460PO	Ø 460cm	500x500 cm
KIT350PO	Ø 350cm	400x400 cm
KIT240PO	Ø 240cm	300x300 cm



Depuradora arena  
(Caudal grupo 3/4 m<sup>3</sup>/h)  
Sand filter  
(Flow group 3/4 m<sup>3</sup>/h)  
Filtre à sable  
(Débit groupe 3/4 m<sup>3</sup>/h)  
Filtro a sabbia  
(Portata gruppo 3/4 m<sup>3</sup>/h)

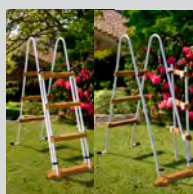

Escalera de seguridad  
2x3 Peldaños  
Safety Ladder  
2x3 Steps  
Échelle sécurité  
2x3 Marches  
Scala di sicurezza  
2x3 Gradini

dream pool serie

# AMAZONIA



KITPROV6188WO



EAN 13

KITPROV7388WO	730x375 cm	132 cm	28.217 l	348 kg	1/120x80	5m <sup>3</sup> /h	√	√	15	12	8 4 1 2 0 8 1 2 5 7 3 3 4
KITPROV6188WO	610x375 cm	132 cm	23.281 l	279 kg	1/90x80	5m <sup>3</sup> /h	√	√	15	12	8 4 1 2 0 8 1 2 5 7 3 4 1

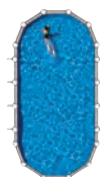

MEDIDA PISCINA  
POOL SIZE  
DIMENSIONS PISCINE  
MISURA PISCINA

ESPACIO NECESARIO  
NECESSARY SPACE  
ESPACE NECESSAIRE  
SPAZIO NECESSARIO

KITPROV7388WO	730x375 cm	770x495 cm
KITPROV6188WO	610x375 cm	650x495 cm



Liner PVC azul  
40/100  
PVC blue liner  
40/100  
Liner PVC bleu  
40/100  
Liner PVC blu  
40/100

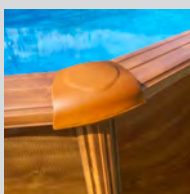

Protectores de  
inyección  
Injection saver  
Protections moulées  
par injection  
Angolare di  
protezione

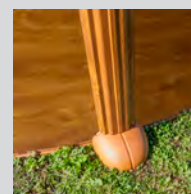

Perfilería de acero  
Steel profiles  
Poteaux et margelles  
acier  
Profili in acciaio

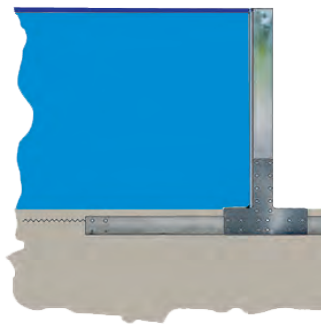

Viga de acero enterrada de 15x15 cm que hace innecesarios los postes exteriores, obteniendo mejor aprovechamiento del jardín.

15x15 cm buried steel beam makes unnecessary the outer buttress, optimizing the use of the garden area.

Poteaux en acier à enterrer de 15x15 cm évitant des renforts apparents extérieurs, pour mieux profiter de l'espace du jardin.

Barra di acciaio interrata da 15x15 cm che non rende necessario l'utilizzo delle barre laterali; permette di poter sfruttare al meglio gli spazi del proprio giardino.



Sistema de omegas Omega system Renforts enterrés Sistema omega



Depuradora arena  
(Caudal grupo 5 m<sup>3</sup>/h)  
Sand filter  
(Flow group 5 m<sup>3</sup>/h)  
Filtre à sable  
(Débit groupe 5 m<sup>3</sup>/h)  
Filtro a sabbia  
(Portata gruppo 5 m<sup>3</sup>/h)



Escalera de seguridad  
Plataforma +2x3 Peldaños  
Safety Ladder  
Platform + 2x3 Steps  
Échelle sécurité  
Plateforme + 2x3 Marches  
Scala di sicurezza  
Piattaforma + 2x3 Gradini



Tapiz protector  
(Polietileno)  
Floor tapestry  
(Polythene)  
Tapis de sol en feutre  
(Polyéthylène)  
Telo di protezione  
(Polietilene)

dream pool serie

# MAURITIUS



KITPROV738WO



EAN 13

Model	Dimensions (LxW)	Height	Volume	Weight	Box Size	Flow Rate	Filter	Ladder	Cover	Accessories	EAN 13
KITPROV738WO	730x375 cm	132 cm	28.217 l	335 kg	1/120x80	5m <sup>3</sup> /h	√	√	15	12	8 412081 257358
KITPROV618WO	610x375 cm	132 cm	23.281 l	270 kg	1/90x80	5m <sup>3</sup> /h	√	√	15	12	8 412081 257365
KITPROV508WO	500x300 cm	132 cm	16.210 l	260 kg	1/90x80	5m <sup>3</sup> /h	√	√	15	12	8 412081 258089



MEDIDA PISCINA  
POOL SIZE  
DIMENSIONS PISCINE  
MISURA PISCINA

ESPACIO NECESARIO  
NECESSARY SPACE  
ESPACE NECESSAIRE  
SPAZIO NECESSARIO

Model	Pool Size	Necessary Space
KITPROV738WO	730x375 cm	770x595 cm
KITPROV618WO	610x375 cm	650x595 cm
KITPROV508WO	500x300 cm	540x520 cm



Liner PVC azul  
40/100  
PVC blue liner  
40/100  
Liner PVC bleu  
40/100  
Liner PVC blu  
40/100

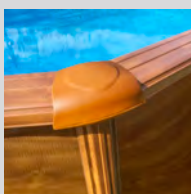

Protectores de  
inyección  
Injection saver  
Protections moulées  
par injection  
Angolare di  
protezione

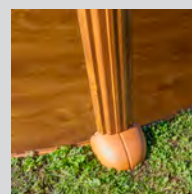

Perfilería de acero  
Steel profiles  
Poteaux et margelles  
acier  
Profili in acciaio



KITPR558WO



EAN 13

	Ø	Height	Capacity	Weight	Box Size	Flow	✓	✓	15	12	Barcode
KITPR558WO	Ø550 cm	132 cm	27.798 l	243 kg	1/90x80	5m³/h	✓	✓	15	12	8 412081 257372
KITPR458WO	Ø460 cm	132 cm	19.444 l	238 kg	1/90x80	5m³/h	✓	✓	15	12	8 412081 257389
KITPR358WO	Ø350 cm	132 cm	11.250 l	184 kg	1/90x80	5m³/h	✓	✓	15	12	8 412081 257396

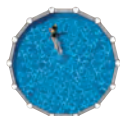

MEDIDA PISCINA  
POOL SIZE  
DIMENSIONS PISCINE  
MISURA PISCINA

ESPACIO NECESARIO  
NECESSARY SPACE  
ESPACE NECESSAIRE  
SPAZIO NECESSARIO

KITPR558WO	Ø 550cm	600x600 cm
KITPR458WO	Ø 460cm	500x500 cm
KITPR358WO	Ø 350cm	400x400 cm



Depuradora arena  
(Caudal grupo 5 m³/h)  
Sand filter  
(Flow group 5 m³/h)  
Filtre à sable  
(Débit groupe 5 m³/h)  
Filtro a sabbia  
(Portata gruppo 5 m³/h)



Escalera de seguridad  
Plataforma +2x3 Peldaños  
Safety Ladder  
Platform + 2x3 Steps  
Échelle sécurité  
Plateforme + 2x3 Marches  
Scala di sicurezza  
Piattaforma + 2x3 Gradini



Tapiz protector  
(Polietileno)  
Floor tapestry  
(Polythene)  
Tapis de sol en feutre  
(Polyéthylène)  
Telo di protezione  
(Polietilene)

# dream pool serie PACIFIC



KIT730W



EAN 13

Model	Dimensions (LxW)	Height	Volume	Weight	Box Size	Flow Rate	Accessories	Steps	Accessories	Barcode
KIT730W	730x375 cm	120 cm	25.323 l	287 kg	1/90x80	4m³/h	√	15	12	8 4 1 2 0 8 1 2 3 2 2 4 9
KIT610W	610x375 cm	120 cm	20.893 l	235 kg	1/80x60	3m³/h	√	15	12	8 4 1 2 0 8 1 2 2 5 1 0 4
KIT500W	500x300 cm	120 cm	14.550 l	224 kg	1/80x60	3m³/h	√	15	12	8 4 1 2 0 8 1 2 3 1 0 6 8

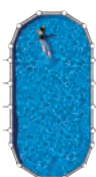

MEDIDA PISCINA  
POOL SIZE  
DIMENSIONS PISCINE  
MISURA PISCINA

ESPACIO NECESARIO  
NECESSARY SPACE  
ESPACE NECESSAIRE  
SPAZIO NECESSARIO

KIT730W	730x375 cm	770x595 cm
KIT610W	610x375 cm	650x595 cm
KIT500W	500x300 cm	540x520 cm



Liner PVC azul  
40/100  
PVC blue liner  
40/100  
Liner PVC bleu  
40/100  
Liner PVC blu  
40/100  
KIT500/460/350/240W: 30/100

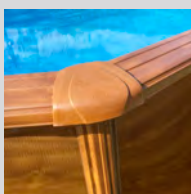

Protectores de  
inyección  
Injection saver  
Protections moulées  
par injection  
Angolare di  
protezione

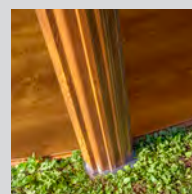

Perfilería de acero  
Steel profiles  
Poteaux et margelles  
acier  
Profili in acciaio





KIT460W



EAN 13

	Ø	H	V	M	D	F	L	W	W	W
KIT460W	Ø460 cm	120 cm	17.450 l	172 kg	1/80x60	3m³/h	√	15	12	8 412081 225111
KIT350W	Ø350 cm	120 cm	10.102 l	146 kg	1/80x60	3m³/h	√	15	12	8 412081 225722
KIT240W	Ø240 cm	120 cm	4.750 l	126 kg	1/80x60	3m³/h	√	15	12	8 412081 226163

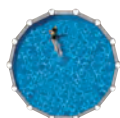

MEDIDA PISCINA  
POOL SIZE  
DIMENSIONS PISCINE  
MISURA PISCINA

ESPACIO NECESARIO  
NECESSARY SPACE  
ESPACE NECESSAIRE  
SPAZIO NECESSARIO

KIT460W	Ø 460cm	500x500 cm
KIT350W	Ø 350cm	400x400 cm
KIT240W	Ø 240cm	300x300 cm



Depuradora arena  
(Caudal grupo 3/4 m³/h)  
Sand filter  
(Flow group 3/4 m³/h)  
Filtre à sable  
(Débit groupe 3/4 m³/h)  
Filtro a sabbia  
(Portata gruppo 3/4 m³/h)

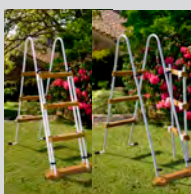

Escalera de seguridad  
2x3 Peldaños  
Safety Ladder  
2x3 Steps  
Échelle sécurité  
2x3 Marches  
Scala di sicurezza  
2x3 Gradini

# dream pool serie SICILIA



KITPROV503W



EAN 13

KITPROV503W

500x300 cm

120 cm

14.550 l

205 kg

1/80x60

3,8m<sup>3</sup>/h

√

15

12



MEDIDA PISCINA  
POOL SIZE  
DIMENSIONS PISCINE  
MISURA PISCINA

ESPACIO NECESARIO  
NECESSARY SPACE  
ESPACE NECESSAIRE  
SPAZIO NECESSARIO

KITPROV503W

500x300 cm

540x520 cm



Liner PVC azul  
30/100  
PVC blue liner  
30/100  
Liner PVC bleu  
30/100  
Liner PVC blu  
30/100

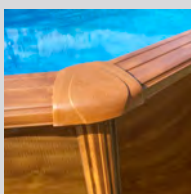

Protectores de  
inyección  
Injection saver  
Protections moulées  
par injection  
Angolare di  
protezione

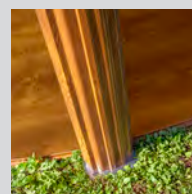

Perfilería de acero  
Steel profiles  
Poteaux et margelles  
acier  
Profili in acciaio



KITPR453W



EAN 13

	Ø	H	Capacidad	Peso	Paquetes	Flujo	✓	Altura	Profundidad	Barcode
KITPR453W	Ø460 cm	120 cm	17.450 l	149 kg	3/120x80	3,8m³/h	✓	15	12	8 412081 258171
KITPR353W	Ø350 cm	120 cm	10.102 l	109 kg	3/120x80	3,8m³/h	✓	15	12	8 412081 258188
KITPR303W	Ø300 cm	120 cm	7.418 l	94 kg	3/120x80	3,8m³/h	✓	15	12	8 412081 265087

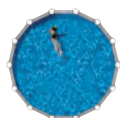

MEDIDA PISCINA  
POOL SIZE  
DIMENSIONS PISCINE  
MISURA PISCINA

ESPACIO NECESARIO  
NECESSARY SPACE  
ESPACE NECESSAIRE  
SPAZIO NECESSARIO

KITPR453W	Ø 460cm	500x500 cm
KITPR353W	Ø 350cm	400x400 cm
KITPR303W	Ø 300cm	350x350 cm

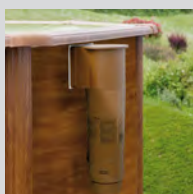

Filtro de cartucho  
(3,8 m³/h)  
Cartidge filter  
(3,8 m³/h)  
Filtre à cartouche  
(3,8 m³/h)  
Filtro a cartuccia  
(3,8 m³/h)

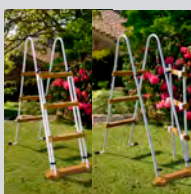

Escalera de seguridad  
2x3 Peldaños  
Safety Ladder  
2x3 Steps  
Échelle sécurité  
2x3 Marches  
Scala di sicurezza  
2x3 Gradini

dream pool serie

HAITI



KITPROV9188



EAN 13

	1000x550 cm	915x470 cm	800x470 cm	730x375 cm	610x375 cm
KITPROV10288	1000x550 cm	915x470 cm	800x470 cm	730x375 cm	610x375 cm
	132 cm	132 cm	132 cm	132 cm	132 cm
	56.111 l	43.595 l	37.474 l	28.217 l	23.281 l
	681 kg	570 kg	474 kg	348 kg	279 kg
	1/120x100	1/120x80	1/120x80	1/120x80	1/90x80
	10m³/h	8m³/h	7m³/h	5m³/h	5m³/h
	√	√	√	√	√
	√	√	√	√	√
	15	15	15	15	15
	12	12	12	12	12
	8 4 1 2 0 8 1 2 2 4 6 2 6	8 4 1 2 0 8 1 2 2 0 2 1 5	8 4 1 2 0 8 1 2 2 4 6 3 3	8 4 1 2 0 8 1 2 2 0 2 2 2	8 4 1 2 0 8 1 2 2 1 3 2 8

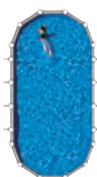
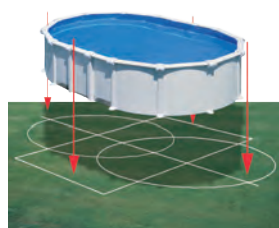

MEDIDA PISCINA  
POOL SIZE  
DIMENSIONS PISCINE  
MISURA PISCINA

ESPACIO NECESARIO  
NECESSARY SPACE  
ESPACE NECESSAIRE  
SPAZIO NECESSARIO

KITPROV10288	1000x550 cm	1040x670 cm
KITPROV9188	915x470 cm	955x590 cm
KITPROV8188	800x470 cm	850x590 cm
KITPROV7388	730x375 cm	770x495 cm
KITPROV6188	610x375 cm	650x495 cm



Liner PVC azul  
40/100  
PVC blue liner  
40/100  
Liner PVC bleu  
40/100  
Liner PVC blu  
40/100



Protectores de  
inyección  
Injection saver  
Protections moulées  
par injection  
Angolare di  
protezione



Perfilería de acero  
Steel profiles  
Poteaux et margelles  
acier  
Profili in acciaio

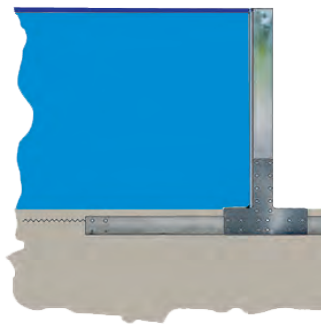

Viga de acero enterrada de 15x15 cm que hace innecesarios los postes exteriores, obteniendo mejor aprovechamiento del jardín.

15x15 cm buried steel beam makes unnecessary the outer buttress, optimizing the use of the garden area.

Poteaux en acier à enterrer de 15x15 cm évitant des renforts apparents extérieurs, pour mieux profiter de l'espace du jardin.

Barra di acciaio interrata da 15x15 cm che non rende necessario l'utilizzo delle barre laterali; permette di poter sfruttare al meglio gli spazi del proprio giardino.



Sistema de omegas Omega system Renforts enterrés Sistema omega



Depuradora arena  
(Caudal grupo 10/8/7/5 m<sup>3</sup>/h)  
Sand filter  
(Flow group 10/8/7/5 m<sup>3</sup>/h)  
Filtre à sable  
(Débit groupe 10/8/7/5 m<sup>3</sup>/h)  
Filtro a sabbia  
(Portata gruppo 10/8/7/5 m<sup>3</sup>/h)



Escalera de seguridad  
Plataforma +2x3 Peldaños  
Safety Ladder  
Platform + 2x3 Steps  
Échelle sécurité  
Plateforme + 2x3 Marches  
Scala di sicurezza  
Piattaforma + 2x3 Gradini



Tapiz protector  
(Polietileno)  
Floor tapestry  
(Polythene)  
Tapis de sol en feutre  
(Polyéthylène)  
Telo di protezione  
(Polietilene)

dream pool serie

# ATLANTIS



KITPROV918



EAN 13

KITPROV1028	1000x550 cm	132 cm	56.111 l	482 kg	1/120x100	10m³/h	√	√	15	12	8 4 12081 220239	
KITPROV918	915x470 cm	132 cm	43.595 l	466 kg	1/120x80	8m³/h	√	√	15	12	8 4 12081 211978	
KITPROV818	800x470 cm	132 cm	37.474 l	415 kg	1/120x80	7m³/h	√	√	15	12	8 4 12081 211565	
KITPROV738	730x375 cm	132 cm	28.217 l	348 kg	1/120x80	5m³/h	√	√	15	12	8 4 12081 211985	
KITPROV618	610x375 cm	132 cm	23.281 l	279 kg	1/90x80	5m³/h	√	√	15	12	8 4 12081 211572	
KITPROV508	500x300 cm	132 cm	16.210 l	260 kg	1/90x80	5m³/h	√	√	15	12	8 4 12081 258119	

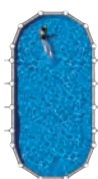
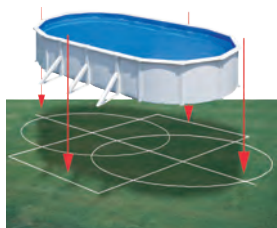

	MEDIDA PISCINA POOL SIZE DIMENSIONS PISCINE MISURA PISCINA	ESPACIO NECESARIO NECESSARY SPACE ESPACE NECESSAIRE SPAZIO NECESSARIO
KITPROV1028	1000x550 cm	1040x770 cm
KITPROV918	915x470 cm	955x690 cm
KITPROV818	800x470 cm	850x690 cm
KITPROV738	730x375 cm	770x595 cm
KITPROV618	610x375 cm	650x595 cm
KITPROV508	500x300 cm	540x520 cm



Liner PVC azul  
40/100  
PVC blue liner  
40/100  
Liner PVC bleu  
40/100  
Liner PVC blu  
40/100



Protectores de  
inyección  
Injection saver  
Protections moulées  
par injection  
Angolare di  
protezione



Perfilería de acero  
Steel profiles  
Poteaux et margelles  
acier  
Profili in acciaio



KITPR558



EAN 13

Model	Ø	Height	Capacity (l)	Weight (kg)	Box Size	Flow (m³/h)	✓	✓	15	12	Barcode
KITPR558	Ø550 cm	132 cm	27.798 l	243 kg	1/90x80	5m³/h	✓	✓	15	12	8 4 12081 211589
KITPR458	Ø460 cm	132 cm	19.444 l	238 kg	1/90x80	5m³/h	✓	✓	15	12	8 4 12081 211596
KITPR358	Ø350 cm	132 cm	11.250 l	184 kg	1/90x80	5m³/h	✓	✓	15	12	8 4 12081 233864

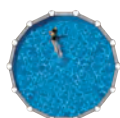
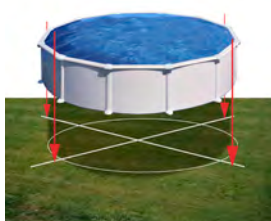

MEDIDA PISCINA  
POOL SIZE  
DIMENSIONS PISCINE  
MISURA PISCINA

ESPACIO NECESARIO  
NECESSARY SPACE  
ESPACE NECESSAIRE  
SPAZIO NECESSARIO

Model	Ø	Required Space
KITPR558	Ø 550cm	600x600 cm
KITPR458	Ø 460cm	500x500 cm
KITPR358	Ø 350cm	400x400 cm



Depuradora arena  
(Caudal grupo 10/8/7/5 m³/h)  
Sand filter  
(Flow group 10/8/7/5 m³/h)  
Filtre à sable  
(Débit groupe 10/8/7/5 m³/h)  
Filtro a sabbia  
(Portata gruppo 10/8/7/5 m³/h)



Escalera de seguridad  
Plataforma +2x3 Peldaños  
Safety Ladder  
Platform + 2x3 Steps  
Échelle sécurité  
Plateforme + 2x3 Marches  
Scala di sicurezza  
Piattaforma + 2x3 Gradini



Tapiz protector  
(Poliétileno)  
Floor tapestry  
(Polythene)  
Tapis de sol en feutre  
(Polyéthylène)  
Telo di protezione  
(Poliétilene)

# dream pool serie **FIDJI**



KIT730ECO



EAN 13

Model	Dimensions (cm)	Height (cm)	Capacity (l)	Weight (kg)	Box Size (cm)	Flow Rate (m³/h)	Accessories	Steps	Accessories	Barcode
KIT810ECO	800x470	120	33.630	298	1/90x80	5m³/h	√	15	12	8 412081 266350
KIT730ECO	730x375	120	25.323	287	1/90x80	4m³/h	√	15	12	8 412081 211398
KIT610ECO	610x375	120	20.893	235	1/80x60	3m³/h	√	15	12	8 412081 211404
KIT500ECO	500x300	120	14.550	224	1/80x60	3m³/h	√	15	12	8 412081 231037

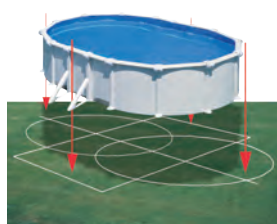

MEDIDA PISCINA  
POOL SIZE  
DIMENSIONS PISCINE  
MISURA PISCINA

ESPACIO NECESARIO  
NECESSARY SPACE  
ESPACE NECESSAIRE  
SPAZIO NECESSARIO

Model	Dimensions (cm)	Necessary Space (cm)
KIT810ECO	800x470	850x690
KIT730ECO	730x375	770x595
KIT610ECO	610x375	650x595
KIT500ECO	500x300	540x520



Liner PVC azul 30/100  
KIT730/KIT610: 40/100  
PVC blue liner 30/100  
KIT730/KIT610: 40/100  
Liner PVC bleu 30/100  
KIT730/KIT610: 40/100  
Liner PVC blu 30/100  
KIT730/KIT610: 40/100



Protectores de inyección  
Injection saver  
Iniection saver  
Protections moulées par injection  
Angolare di protezione



Perfilería de acero  
Steel profiles  
Poteaux et margelles acier  
Profili in acciaio





KIT460ECO



EAN 13

Model	Pool Diameter	Pool Height	Volume	Weight	Box Size	Flow Rate	Filter	Steps	Steps	Steps	Barcode
KIT550ECO	Ø550 cm	120 cm	24.944 l	209 kg	1/80x60	4m³/h	√	15	12	12	8 4 1 2 0 8 1 2 1 1 4 1 1
KIT460ECO	Ø460 cm	120 cm	17.450 l	172 kg	1/80x60	3m³/h	√	15	12	12	8 4 1 2 0 8 1 2 1 1 4 2 8
KIT350ECO	Ø350 cm	120 cm	10.102 l	146 kg	1/80x60	3m³/h	√	15	12	12	8 4 1 2 0 8 1 2 1 1 4 3 5
KIT300ECO	Ø300 cm	120 cm	7.418 l	136 kg	1/80x60	3m³/h	√	15	12	12	8 4 1 2 0 8 1 2 2 8 7 5 4
KIT240ECO	Ø240 cm	120 cm	4.750 l	120 kg	1/80x60	3m³/h	√	15	12	12	8 4 1 2 0 8 1 2 4 0 8 3 1

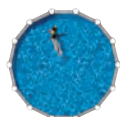
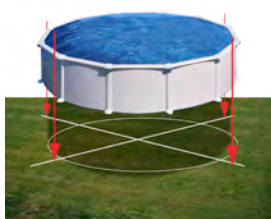

MEDIDA PISCINA  
POOL SIZE  
DIMENSIONS PISCINE  
MISURA PISCINA

ESPACIO NECESARIO  
NECESSARY SPACE  
ESPACE NECESSAIRE  
SPAZIO NECESSARIO

Model	Pool Diameter	Necessary Space
KIT550ECO	Ø 550 cm	600x600 cm
KIT460ECO	Ø 460 cm	500x500 cm
KIT350ECO	Ø 350 cm	400x400 cm
KIT300ECO	Ø 300 cm	350x350 cm
KIT240ECO	Ø 240 cm	300x300 cm



Depuradora arena  
(Caudal grupo 3/4/5 m³/h)  
Sand filter  
(Flow group 3/4/5 m³/h)  
Filtre à sable  
(Débit groupe 3/4/5 m³/h)  
Filtro a sabbia  
(Portata gruppo 3/4/ 5 m³/h)

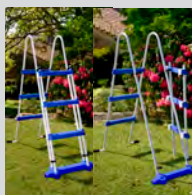

Escalera de seguridad  
2x3 Peldaños  
Safety Ladder  
2x3 Steps  
Échelle sécurité  
2x3 Marches  
Scala di sicurezza  
2x3 Gradini

# dream pool serie VARADERO



KITPROV7070



EAN 13

	Dimensions	Capacity	Weight	Storage	Flow Rate	Accessories	Height	Depth	Barcode
KITPROV6270	640x390 cm	20.652 l	311 kg	1/90x80	4m <sup>3</sup> /h	√	√	15 12	8 4 12081 211633
KITPROV4870	500x340 cm	13.696 l	284 kg	1/90x80	4m <sup>3</sup> /h	√	√	15 12	8 4 12081 231921

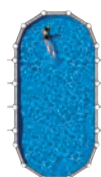
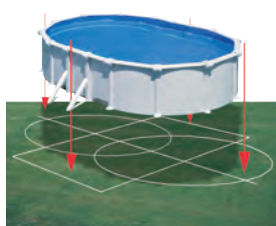

	MEDIDA PISCINA POOL SIZE DIMENSIONS PISCINE MISURA PISCINA	ESPACIO NECESARIO NECESSARY SPACE ESPACE NECESSAIRE SPAZIO NECESSARIO
KITPROV6270	640x390 cm	700x430 cm
KITPROV4870	500x340 cm	540x380 cm



Liner PVC azul  
40/100  
PVC blue liner  
40/100  
Liner PVC bleu  
40/100  
Liner PVC blu  
40/100



Protectores de  
inyección  
Injection saver  
Protections moulées  
par injection  
Angolare di  
protezione



Perfilería de acero  
Steel profiles  
Poteaux et margelles  
acier  
Profili in acciaio



Viga de acero enterrada de 15x15 cm que hace innecesarios los postes exteriores, obteniendo mejor aprovechamiento del jardín.

15x15 cm buried steel beam makes unnecessary the outer buttress, optimizing the use of the garden area.

Poteaux en acier à enterrer de 15x15 cm évitant des renforts apparents extérieurs, pour mieux profiter de l'espace du jardin.

Barra di acciaio interrata da 15x15 cm che non rende necessario l'utilizzo delle barre laterali; permette di poter sfruttare al meglio gli spazi del proprio giardino.



Sistema de omegas Omega system Renforts enterrés Sistema omega



Depuradora arena  
(Caudal grupo 4 m<sup>3</sup>/h)  
Sand filter  
(Flow group 4 m<sup>3</sup>/h)  
Filtre à sable  
(Débit groupe 4 m<sup>3</sup>/h)  
Filtro a sabbia  
(Portata gruppo 4 m<sup>3</sup>/h)

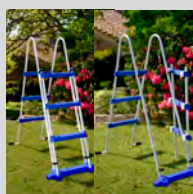

Escalera de seguridad  
2x3 Peldaños  
Safety Ladder  
2x3 Steps  
Échelle sécurité  
2x3 Marches  
Scala di sicurezza  
2x3 Gradini



Tapiz protector  
(Polietileno)  
Floor tapestry  
(Polythene)  
Tapis de sol en feutre  
(Polyéthylène)  
Telo di protezione  
(Polietilene)

dream pool serie

# BORA BORA



KITPROV613



EAN 13

KITPROV613	610x375 cm	120 cm	20.893 l	210 kg	1/80x60	3,8m <sup>3</sup> /h	√	15	12	
KITPROV503	500x300 cm	120 cm	14.550 l	205 kg	1/80x60	3,8m <sup>3</sup> /h	√	15	12	

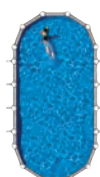
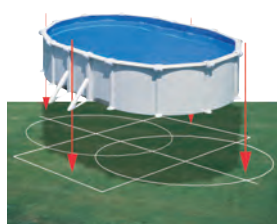

MEDIDA PISCINA  
POOL SIZE  
DIMENSIONS PISCINE  
MISURA PISCINA

ESPACIO NECESARIO  
NECESSARY SPACE  
ESPACE NECESSAIRE  
SPAZIO NECESSARIO

KITPROV613	610x375 cm	650x595 cm
KITPROV503	500x300 cm	540x520 cm



Liner PVC azul  
40/100  
PVC blue liner  
40/100  
Liner PVC bleu  
40/100  
Liner PVC blu  
40/100  
KITPROV503/KITPR453/353/303: 30/100



Protectores de  
inyección  
Injection saver  
Protections moulées  
par injection  
Angolare di  
protezione



Perfilería de acero  
Steel profiles  
Poteaux et margelles  
acier  
Profili in acciaio



KITPR453



EAN 13

	Ø	Height	Capacity	Weight	Box	Flow	✓	Steps	Height	Depth	Barcode
KITPR453	Ø460 cm	120 cm	17.450 l	149 kg	1/80x40	3,8m³/h	✓	15	12	8 4 1 2 0 8 1 2 0 9 0 0 5	
KITPR353	Ø350 cm	120 cm	10.102 l	109 kg	1/80x40	3,8m³/h	✓	15	12	8 4 1 2 0 8 1 2 0 9 0 1 2	
KITPR303	Ø300 cm	120 cm	7.418 l	94 kg	1/80x40	3,8m³/h	✓	15	12	8 4 1 2 0 8 1 2 3 3 9 0 1	

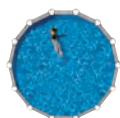
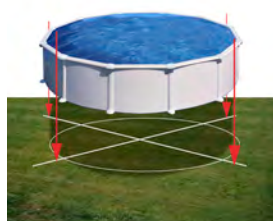

MEDIDA PISCINA  
POOL SIZE  
DIMENSIONS PISCINE  
MISURA PISCINA

ESPACIO NECESARIO  
NECESSARY SPACE  
ESPACE NECESSAIRE  
SPAZIO NECESSARIO

	Pool Size	Necessary Space
KITPR453	Ø 460 cm	500x500 cm
KITPR353	Ø 350 cm	400x400 cm
KITPR303	Ø 300 cm	350x350 cm



Filtro de cartucho  
(3,8 m³/h)  
Cartidge filter  
(3,8 m³/h)  
Filtre à cartouche  
(3,8 m³/h)  
Filtro a cartuccia  
(3,8 m³/h)

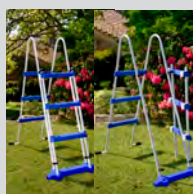

Escalera de seguridad  
2x3 Peldaños  
Safety Ladder  
2x3 Steps  
Échelle sécurité  
2x3 Marches  
Scala di sicurezza  
2x3 Gradini

dream pool serie

# LANZAROTE

KITWPR452E



EAN 13

Model	Ø	Height	Capacity	Weight	Box Size	Flow Rate	Filter	Steps	Accessories	Barcode
KITWPR452E	Ø450 cm	90 cm	12.717 l	56 kg	8/120x80	2m³/h	√	3,5	3,5	8 4 1 2 0 8 1 2 4 1 4 1 8
KITWPR352E	Ø350 cm	90 cm	7.693 l	47 kg	8/120x80	2m³/h	√	3,5	3,5	8 4 1 2 0 8 1 2 4 1 4 0 1
KITWPR302	Ø300 cm	90 cm	6.358 l	44 kg	8/120x80	2m³/h	√	3,5	3,5	8 4 1 2 0 8 1 2 3 1 0 4 4

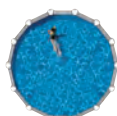
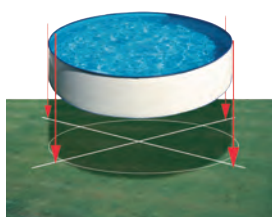

MEDIDA PISCINA  
POOL SIZE  
DIMENSIONS PISCINE  
MISURA PISCINA

ESPACIO NECESARIO  
NECESSARY SPACE  
ESPACE NECESSAIRE  
SPAZIO NECESSARIO

Model	Ø	Required Space
KITWPR452E	Ø 450 cm	500x500 cm
KITWPR352E	Ø 350 cm	400x400 cm
KITWPR302	Ø 300 cm	350x350 cm



Liner PVC azul  
20/100  
PVC blue liner  
20/100  
Liner PVC bleu  
20/100  
Liner PVC blu  
20/100



Filtro de cartucho:  
2 m³/h  
Cartidge filter  
2 m³/h  
Filtre à cartouche  
2 m³/h  
Filtro a cartuccia  
2 m³/h

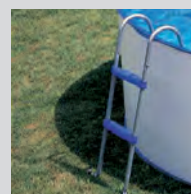

Escalera  
2x2 Peldaños  
Ladder  
2x2 Steps  
Echelle  
2x2 Marches  
Scala  
2x2 Gradini

dream pool serie **TENERIFE**



KITWPR450E



EAN 13

KITWPR450E	Ø450 cm	90 cm	12.717 l	56 kg	8/120x80	2m³/h	√	3,5	3,5	8 4 120 81 24 12 10
KITWPR350E	Ø350 cm	90 cm	7.693 l	47 kg	8/120x80	2m³/h	√	3,5	3,5	8 4 120 81 24 12 03

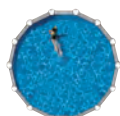
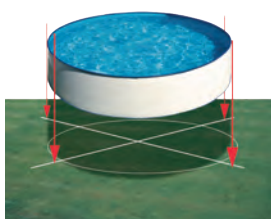

	MEDIDA PISCINA POOL SIZE DIMENSIONS PISCINE MISURA PISCINA	ESPACIO NECESARIO NECESSARY SPACE ESPACE NECESSAIRE SPAZIO NECESSARIO
KITWPR450E	Ø 450 cm	500x500 cm
KITWPR350E	Ø 350 cm	400x400 cm



## Leyenda Legend Légende Legenda

### **BX**

caja  
box  
box  
scatola

### **BXL**

caja con etiqueta  
box and label  
carton avec étiquette  
scatola con etichetta

### **CB**

cartoncillo  
cardboard wrap  
bande carton  
cartone

### **CBX**

caja litografiada  
colour box  
boîte de couleur  
scatola serigrafata

### **PB**

bolsa de plástico  
polybag  
sac plastique  
busta di plastica

### **PBH**

bolsa de plástico con cartoncillo  
polybag with header  
sac plastique avec bande carton  
sacchetto di plastica con cartone

### **BL**

blister  
blister  
blister  
blister

### **CS**

doble burbuja  
clamshell  
double coque  
doppio rivestimento

### **DIS**

display  
display  
display  
display



# complementos complements

COMPLEMENTOS	78	COMPLEMENTS
Cubiertas isotérmicas para piscinas de madera	80	Wooden pool isothermic covers
Cubiertas de invierno para piscinas de madera	81	Wooden pool winter covers
Cubiertas isotérmicas para piscinas de composite	82	Composite pool isothermic covers
Cubiertas de invierno para piscinas de composite	82	Composite pool winter covers
Cubiertas isotérmicas para piscinas enterrada	83	In ground pool isothermic covers
Cubiertas isotérmicas	84	Isothermic covers
Cubiertas de invierno	85	Winter covers
Mantas	86	Bottom protective blankets
Enrolladores de cubiertas	87	Telescopic cover rollers
Liners	89	Liners
Protectores	92	Protectors
Reparadores de liner	95	Liner repairs
Escaleras para piscinas enterradas	96	Inground pool ladders
Escaleras para piscina de madera	97	Wooden pool ladder
Escaleras para piscinas sobre suelo	98	Above-ground pool ladders
Monoblocs de filtración	100	Filtration kit
Bombas	102	Pumps
Locales técnicos	104	Technical rooms
Cargas filtrantes	105	Filter media
Mangueras de filtración	106	Filtration hoses
Adaptadores	107	Adapters
Skimmers	108	Skimmers
Repuestos de filtración	108	Filtration spare parts
Filtros de Cartucho	111	Cartridge filter
Cartuchos	111	Cartridges
Tratamiento de agua	112	Water treatment
Electrolisis de sal	112	Electrolysis of salt
Blue Connect	113	Blue Connect
Sistemas de dosificación	114	Dosing systems
Seguridad piscina	115	Pool security
Iluminación	116	Lighting
Calefacción	120	Heating systems
Calefacción solar	122	Solar heating system
Duchas	123	Showers
Racordería	128	PVC Fittings

# complements complementi

COMPLEMENTS	78	COMPLEMENTI
Couvertures isothermes pour piscines bois	80	Coperture isotermiche per piscine in legno
Couvertures pour l'hiver pour piscines bois	81	Copertura invernale per piscine in legno
Couvertures isothermes pour piscines composite	82	Coperture isotermiche per piscine composite
Couvertures pour l'hiver pour piscines composite	82	Copertura invernale per piscine composite
Couvertures pour l'hiver pour piscines enterrées	83	Copertura invernale per piscine interrata
Couvertures isothermes	84	Coperture isotermiche
Couvertures pour l'hiver	85	Copertura invernale
Tapis de sol	86	Telo di protezione fondi
Enrouleurs de bâches	87	Avvolgitore
Liners	89	Liners
Protecteurs	92	Protezioni
Réparation liner	95	Riparazione liner
Échelles pour piscines enterrées	96	Scaletta per piscina interrata
Échelle pour piscines bois	97	Scaletta per piscina in legno
Échelles pour piscines hors sol	98	Scaletta per piscina fuori terra
Filtre a sable	100	Filtro monoblocco
Pompes	102	Pompe
Local technique	104	Locale tecnico
Médias filtrants	105	Carico filtrante
Tuyaux pour épurateurs	106	Tubi di filtraggio
Adaptateurs	107	Adattatori
Skimmers	108	Skimmers
Accessoires pour filtration	108	Filtraggio parti
Epurateur à cartouche	111	Filtri a cartuccia
Cartouches	111	Cartucce
Traitement d'eau	112	Trattamento acqua
Electrolyse au sel	112	Elettrolisi salina
Blue Connect	113	Blue Connect
Système de dosage	114	Sistemi di dosaggio
Protection pour piscine	115	Protezione per piscine
Éclairage	116	Illuminazione
Chauffage	120	Riscaldamento
Chauffage solaire	122	Riscaldamento solare
Douches	123	Docce
Raccords PVC	128	Racorderia in PVC

# complementos complements













## CUBIERTAS ISOTÉRMICAS PARA PISCINAS DE MADERA WOODEN POOL ISOTHERMIC COVERS BÂCHES ÉTÉ POUR PISCINES BOIS COPERTURE ISOTHERMICH PER PISCINE IN LEGNO



**Material: Polietileno**  
**Material: Polyethylene**  
**Matériau: Polyéthylène**  
**Materiale: Polietilene**

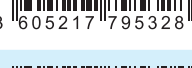
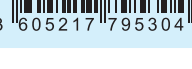
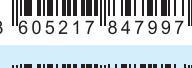
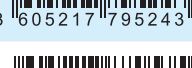

**EAN 13**

<b>786642</b> CARDAMON	1113x375	400 µ	-	-	-	1118x380	-	BXL pack 1	 3 605217 866424
<b>786641</b> MINT	965x375	400 µ	-	-	-	970x380	-	BXL pack 1	 3 605217 866417
<b>786640</b> ANISE	865x275	400 µ	-	-	-	870x280	-	BXL pack 1	 3 605217 866400
<b>788922</b> BRAGA	747x347	400 µ	-	-	-	752x352	-	BXL pack 1	 3 605217 889225
<b>788921</b> EVORA	547x347	400 µ	-	-	-	552x352	-	BXL pack 1	 3 605217 889218
<b>788453</b> MARBELLA	374x224	400 µ	-	-	-	379x229	-	BXL pack 1	 3 605217 884534
<b>788920</b> CARRA	262x262	400 µ	-	-	-	-	267x267	BXL pack 1	 3 605217 889201
<b>786637</b> AVILA	889x539	400 µ	894x544	-	-	-	-	BXL pack 1	 3 605217 866370
<b>786636</b> SEVILLA	818x418	400 µ	823x423	-	-	-	-	BXL pack 1	 3 605217 866363
<b>786634</b> VERMELA	618x418	400 µ	623x423	-	-	-	-	BXL pack 1	 3 605217 866349
<b>784800</b> SAFRAN	585x360	400 µ	-	590x365	-	-	-	BXL pack 1	 3 605217 848000
<b>779532</b> CANNELLE	498x298	400 µ	-	503x303	-	-	-	BXL pack 1	 3 605217 795328
<b>779530</b> GRENADE	398x298	400 µ	-	403x303	-	-	-	BXL pack 1	 3 605217 795304
<b>784799</b> VIOLETTE	453 ø	400 µ	-	-	460 ø	-	-	BXL pack 1	 3 605217 847997
<b>779524</b> VANILLE	350 ø	400 µ	-	-	355 ø	-	-	BXL pack 1	 3 605217 795243
<b>787057</b> LILLI	250 ø	400 µ	-	-	255 ø	-	-	BXL pack 1	 3 605217 870575





## CUBIERTAS DE INVIERNO PARA PISCINAS DE MADERA **WOODEN POOL WINTER COVERS** BÂCHES HIVER POUR PISCINES BOIS **COPERTURE INVERNALE PER PISCINE IN LEGNO**



**Material: PVC armado**  
**Material: Armed PVC**  
**Matériau: PVC armé**  
**Materiale: PVC armato**

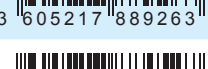

**EAN 13**

<b>778042</b> CARDAMON	1258x467	580 g/m <sup>2</sup>	-	-	-	1218x427	-	BXL pack 1	
<b>778041</b> MINT	1058x467	580 g/m <sup>2</sup>	-	-	-	1018x427	-	BXL pack 1	
<b>778040</b> ANISE	958x367	580 g/m <sup>2</sup>	-	-	-	918x327	-	BXL pack 1	
<b>788927</b> BRAGA	840x440	580 g/m <sup>2</sup>	-	-	-	800x400	-	BXL pack 1	
<b>788926</b> EVORA	640x440	580 g/m <sup>2</sup>	-	-	-	600x400	-	BXL pack 1	
<b>788452</b> MARBELLA	467x317	580 g/m <sup>2</sup>	-	-	-	427x277	-	BXL pack 1	
<b>788925</b> CARRA	340x340	580 g/m <sup>2</sup>	-	-	-	-	300x300	BXL pack 1	
<b>790001</b> CITY	250x250	580 g/m <sup>2</sup>	-	-	-	-	225x225	BXL pack 1	
<b>786639</b> AVILA	982x632	580 g/m <sup>2</sup>	942x592	-	-	-	-	BXL pack 1	
<b>621104</b> SEVILLA	912x512	580 g/m <sup>2</sup>	872x472	-	-	-	-	BXL pack 1	
<b>621103</b> VERMELA	712x512	580 g/m <sup>2</sup>	672x472	-	-	-	-	BXL pack 1	
<b>779537</b> SAFRAN	677x452	580 g/m <sup>2</sup>	-	637x412	-	-	-	BXL pack 1	
<b>786754</b> CANNELLE	591x391	580 g/m <sup>2</sup>	-	551x351	-	-	-	BXL pack 1	
<b>779531</b> GRENADE	476x376	580 g/m <sup>2</sup>	-	436x336	-	-	-	BXL pack 1	
<b>784801</b> VIOLETTE	551 ø	580 g/m <sup>2</sup>	-	-	511 ø	-	-	BXL pack 1	
<b>779525</b> VANILLE	452 ø	580 g/m <sup>2</sup>	-	-	412 ø	-	-	BXL pack 1	
<b>787058</b> LILLI	335 ø	580 g/m <sup>2</sup>	-	-	295 ø	-	-	BXL pack 1	

**NEW**

# complementos complements

## CUBIERTAS ISOTÉRMICAS PARA PISCINAS DE COMPOSITE COMPOSITE POOL ISOTHERMIC COVERS BÂCHES ÉTÉ POUR PISCINES COMPOSITE COPERTURE ISOTHERMICHE PER PISCINE COMPOSITE



**Material: Polietileno**  
**Material: Polyethylene**  
**Matériau: Polyéthylène**  
**Materiale: Polietilene**



EAN 13

<b>CVKPCOR60</b>	560x280	400 µ	-	-	-	606x326	BXL pack 1	8 4 1 2 0 8 1 2 7 3 7 0 9
<b>CVKPCOR28</b>	275x275	400 µ	-	-	326x326	-	BXL pack 1	8 4 1 2 0 8 1 3 0 2 6 9 0
<b>CVKPC080</b>	753x333	400 µ	-	758x338	-	-	BXL pack 1	8 4 1 2 0 8 1 2 7 0 6 6 1
<b>CVKPC066</b>	613x333	400 µ	-	618x338	-	-	BXL pack 1	8 4 1 2 0 8 1 2 7 0 6 5 4
<b>CVKPC052</b>	473x333	400 µ	-	478x338	--	-	BXL pack 1	8 4 1 2 0 8 1 2 7 0 6 4 7
<b>CVKPC041</b>	Ø 361	400 µ	Ø 366	-	-	-	BXL pack 1	8 4 1 2 0 8 1 2 7 0 6 3 0

NEW

## CUBIERTAS DE INVIERNO PARA PISCINAS DE COMPOSITE COMPOSITE POOL WINTER COVERS BÂCHES HIVER POUR PISCINES COMPOSITE COPERTURE INVERNALE PER PISCINE COMPOSITE

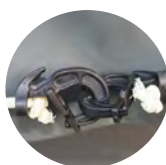

**Material: PVC armado**  
**Material: Armed PVC**  
**Matériau: PVC armé**  
**Materiale: PVC armato**



EAN 13

<b>CIKPCOR60</b>	640x360	580 g/m <sup>2</sup>	-	-	-	606x326	BXL pack 1	8 4 1 2 0 8 1 2 7 3 7 2 3
<b>CIKPCOR28</b>	360x360	580 g/m <sup>2</sup>	-	-	326x326	-	BXL pack 1	8 4 1 2 0 8 1 3 0 2 7 0 6
<b>CIKPC080</b>	828x408	580 g/m <sup>2</sup>	-	804x386	-	-	BXL pack 1	8 4 1 2 0 8 1 2 7 0 7 0 8
<b>CIKPC066</b>	688x408	580 g/m <sup>2</sup>	-	664x386	-	-	BXL pack 1	8 4 1 2 0 8 1 2 7 0 6 9 2
<b>CIKPC052</b>	548x408	580 g/m <sup>2</sup>	-	524x386	-	-	BXL pack 1	8 4 1 2 0 8 1 2 7 0 6 8 5
<b>CIKPC041</b>	Ø 480	580 g/m <sup>2</sup>	Ø 410	-	-	-	BXL pack 1	8 4 1 2 0 8 1 2 7 0 6 7 8

NEW

**CUBIERTAS ISOTÉRMICAS PARA PISCINAS ENTERRADAS IN-GROUND POOLS ISOTHERMIC COVERS**  
**BÂCHES ÉTÉ POUR PISCINES ENTERRÉE COPERTURE ISOTHERMICHE PER PISCINE INTERRATA**



**Material: Polietileno**  
**Material: Polyethylene**  
**Matériau: Polyéthylène**  
**Materiale: Polietileno**



**EAN 13**

<b>CVPE800</b>	795x395	300 µ	-	800x400	-	BXL pack 1	8 4 1 2 0 8 1 2 7 3 9 0 7
<b>CVPE700</b>	695x315	300 µ	-	700x320	-	BXL pack 1	8 4 1 2 0 8 1 2 7 3 9 1 4
<b>CVPE600</b>	595x315	300 µ	-	600x320	-	BXL pack 1	8 4 1 2 0 8 1 2 7 3 9 2 1
<b>CVPE500</b>	495x295	300 µ	-	500x300	-	BXL pack 1	8 4 1 2 0 8 1 2 7 3 9 3 8
<b>CVPE420</b>	Ø 415	300 µ	Ø 420	-	-	BXL pack 1	8 4 1 2 0 8 1 2 7 3 9 4 5
<b>CVPE350</b>	Ø 345	300 µ	Ø 350	-	-	BXL pack 1	8 4 1 2 0 8 1 2 7 3 9 5 2
<b>CPERT105</b>	995x495	180 µ	-	-	1000x500	BXL pack 1	8 4 1 2 0 8 1 2 6 8 3 5 4
<b>CPERT95</b>	895x495	180 µ	-	-	900x500	BXL pack 1	8 4 1 2 0 8 1 2 6 8 3 4 7
<b>CPERT84</b>	795x395	180 µ	-	-	800x400	BXL pack 1	8 4 1 2 0 8 1 2 6 8 3 3 0
<b>CPERT63</b>	595x295	180 µ	-	-	600x300	BXL pack 1	8 4 1 2 0 8 1 2 6 8 3 2 3
<b>CPERT53</b>	495x295	180 µ	-	-	500x300	BXL pack 1	8 4 1 2 0 8 1 2 6 8 3 1 6

# complementos complements

## CUBIERTAS ISOTÉRMICAS ISOTHERMIC COVERS COUVERTURES ISOTHERMES COPERTURE ISOTHERMICHE

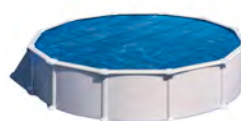
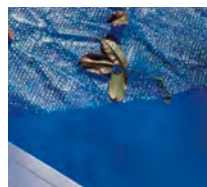

**Material: Polietileno**  
**Material: Polyethylene**  
**Matériau: Polyéthylène**  
**Materiale: Polietilene**



**EAN 13**

<b>CPROV1020</b>	995x545	180 μ	-	1000x550	-	-	-	PBH pack 1	8 4 1 2 0 8 1 2 2 0 5 3 6
<b>CPROV915</b>	910x460	180 μ	-	915x470	-	-	-	PBH pack 1	8 4 1 2 0 8 1 9 8 0 3 2 4
<b>CPROV810</b>	805x460	180 μ	-	810x470	-	-	-	PBH pack 1	8 4 1 2 0 8 1 2 0 5 9 8 4
<b>CPROV730</b>	725x370	180 μ	-	730x375	-	-	-	PBH pack 1	8 4 1 2 0 8 1 9 8 0 3 3 1
<b>CPROV610</b>	605x370	180 μ	-	610x375	-	-	-	PBH pack 1	8 4 1 2 0 8 1 2 0 5 9 9 1
<b>CPROV510</b>	485x335	180 μ	-	500x350	-	-	-	PBH pack 1	8 4 1 2 0 8 1 2 6 8 8 1 1
<b>CPROV505</b>	495x295	180 μ	-	500x300	-	-	-	PBH pack 1	8 4 1 2 0 8 1 2 2 1 8 2 3
<b>CPROV700</b>	672x445	180 μ	-	-	710x475	-	-	PBH pack 1	8 4 1 2 0 8 1 2 0 5 8 3 0
<b>CPROV600</b>	620x370	180 μ	-	-	640x390	-	-	PBH pack 1	8 4 1 2 0 8 1 2 0 5 8 4 7
<b>CPROV500</b>	472x305	180 μ	-	-	500x340	-	-	PBH pack 1	8 4 1 2 0 8 1 2 0 5 8 5 4
<b>CPR650</b>	635 ø	180 μ	-	-	-	ø 640	-	PBH pack 1	8 4 1 2 0 8 1 9 5 0 3 0 3
<b>CPR550</b>	545 ø	180 μ	-	-	-	ø 550	-	PBH pack 1	8 4 1 2 0 8 1 9 4 0 6 0 1
<b>CV450</b>	455 ø	180 μ	ø 550	-	-	ø 460	ø 450/460	PBH pack 1	8 4 1 2 0 8 1 2 0 2 5 2 5
<b>CPR400</b>	395 ø	180 μ	-	-	-	-	ø 400	PBH pack 1	8 4 1 2 0 8 1 9 4 0 6 2 5
<b>CV350</b>	345 ø	180 μ	ø 450	-	-	ø 350	ø 350	PBH pack 1	8 4 1 2 0 8 1 2 0 2 5 3 2
<b>CV300</b>	295 ø	180 μ	ø 350	-	-	ø 300	ø 300	PBH pack 1	8 4 1 2 0 8 1 2 0 2 5 4 9
<b>CV250</b>	245 ø	180 μ	ø 300	-	-	ø 240	-	PBH pack 1	8 4 1 2 0 8 1 2 0 8 5 6 5
<b>773326</b>	730x370	267 μ	-	735x375	-	-	-	PBH pack 1	3 6 0 5 2 1 7 7 3 3 2 6 9
<b>773324</b>	610x370	267 μ	-	615x375	-	-	-	PBH pack 1	3 6 0 5 2 1 7 7 3 3 2 4 5
<b>773322</b>	500x300	267 μ	-	505x305	-	-	-	PBH pack 1	3 6 0 5 2 1 7 7 3 3 2 2 1
<b>773320</b>	Ø 550	267 μ	Ø 555	-	-	Ø 550	-	PBH pack 1	3 6 0 5 2 1 7 7 3 3 2 0 7
<b>772999</b>	Ø 460	267 μ	Ø 465	-	-	Ø 460	-	PBH pack 1	3 6 0 5 2 1 7 7 2 9 9 9 6
<b>772997</b>	Ø 360	267 μ	Ø 365	-	-	Ø 360	-	PBH pack 1	3 6 0 5 2 1 7 7 2 9 9 7 2













## CUBIERTAS DE INVIERNO WINTER COVERS COUVERTURES POUR L'HIVER COPERTURA INVERNALE



**Material: Polietileno**  
**Material: Polyethylene**  
**Matériau: Polyéthylène**  
**Materiale: Polietilene**



**EAN 13**

<b>CIPROV1001</b>	1115x660	120 g/m <sup>2</sup>	-	-	1000x550	-	-	-	CBX pack 3	
<b>CIPROV911</b>	1030x560	120 g/m <sup>2</sup>	-	-	915x470	-	-	-	CBX pack 3	
<b>CIPROV821</b>	930x560	120 g/m <sup>2</sup>	-	-	800x470	710x475	-	-	CBX pack 3	
<b>CIPROV731</b>	820x460	120 g/m <sup>2</sup>	-	-	730x375	640x390	-	-	CBX pack 3	
<b>CIPROV611</b>	680x460	120 g/m <sup>2</sup>	-	-	610x375	500x340	-	-	CBX pack 3	
<b>CIPROV501</b>	610x410	120 g/m <sup>2</sup>	-	-	500x300	-	-	-	CBX pack 3	
<b>CIPR651</b>	730 ø	120 g/m <sup>2</sup>	-	-	-	-	ø 640	-	CBX pack 3	
<b>CIPR551</b>	640 ø	120 g/m <sup>2</sup>	-	-	-	-	ø 550	-	CBX pack 5	
<b>CIPR451</b>	540 ø	120 g/m <sup>2</sup>	-	ø 550	-	-	ø 460	ø 450 ø 460	CBX pack 5	
<b>CIPR401</b>	480 ø	120 g/m <sup>2</sup>	ø 440	ø 450	-	-	-	ø 400	CBX pack 5	
<b>CIPR351</b>	440 ø	120 g/m <sup>2</sup>	ø 360	ø 350 ø 360	-	-	ø 350	ø 350	CBX pack 5	
<b>CIPR301</b>	380 ø	120 g/m <sup>2</sup>	-	-	-	-	ø 300	-	CBX pack 5	
<b>CIPR241</b>	330 ø	120 g/m <sup>2</sup>	-	-	-	-	ø 240	-	CBX pack 5	











## MANTAS PROTECTORAS BOTTOM PROTECTIVE BLANKET POUR LE SOL DES PISCINES COUVERTURES DE PROTECTION DU FOND TAPPETO DI PROTEZIONE



Material: Poliéster  
Material: Polyester  
Matériau: Polyester  
Materiale: Poliestere



EAN 13

<b>MPROV1100</b>	1100x600	110 g/m <sup>2</sup>	-	-	-	1000x550	-	-	-	PBH pack 1	 8 4 120 81 214 528
<b>MPROV915</b>	950x500	110 g/m <sup>2</sup>	-	-	-	915x470	-	-	-	PBH pack 1	 8 4 120 81 980 256
<b>MPROV810</b>	825x500	110 g/m <sup>2</sup>	780x400	-	780x400	810x470	710x475	-	-	PBH pack 1	 8 4 120 81 206 004
<b>MPROV730</b>	750x400	110 g/m <sup>2</sup>	660x280	-	660x280	730x375	640x390	-	-	PBH pack 1	 8 4 120 81 980 263
<b>MPROV610</b>	625x400	110 g/m <sup>2</sup>	530x280	-	530x280	610x375	500x340	-	-	PBH pack 1	 8 4 120 81 206 011
<b>MPROV500</b>	525x325	110 g/m <sup>2</sup>	-	-	-	500x300	-	-	-	PBH pack 1	 8 4 120 81 231 075
<b>MPR650</b>	650x650	110 g/m <sup>2</sup>	-	-	-	-	-	ø 640	-	PBH pack 1	 8 4 120 81 960 111
<b>MPR550</b>	550x550	110 g/m <sup>2</sup>	-	-	ø 550	-	-	ø 550	-	PBH pack 1	 8 4 120 81 960 128
<b>MPR450</b>	450x450	110 g/m <sup>2</sup>	-	ø 440	ø 450	-	-	ø 460 ø 450	ø 460	PBH pack 1	 8 4 120 81 960 135
<b>MPR400</b>	400x400	110 g/m <sup>2</sup>	-	ø 360	-	-	-	ø 350	ø 400	PBH pack 1	 8 4 120 81 960 142
<b>MPR350</b>	350x350	110 g/m <sup>2</sup>	-	-	ø 350	-	-	ø 350 ø 300	ø 350	PBH pack 1	 8 4 120 81 960 159
<b>MPR250</b>	250x250	110 g/m <sup>2</sup>	-	-	ø 240	-	-	ø 240	-	PBH pack 1	 8 4 120 81 208 572



**ENROLLADORES DE CUBIERTAS TELESCOPIC COVER ROLLERS**  
**ENROULEURS DE BÂCHES AVVOGLITORE PER PISCINE**

REF. 90171

BXL PACK 1



**Enrollador piscinas enterradas**

Enrollador de cubierta para piscinas enterradas. Ofrece un desarrollo máximo de 5,50m. Ideal para piscinas redondas, cuadradas u ovaladas. Contiene tubos redondos en aluminio anodizado, un volante ergonómico con empuñadura giratoria así como un kit para atar la cubierta.

**Enrouleur pour piscines enterrées**

Enrouleur de bâche pour piscines enterrées. Il offre un développement maximum de 5,50m. Il convient aux piscines rondes, carrées ou ovales. Il est équipé de tubes ronds en aluminium anodisés, d'un volant ergonomique avec poignée tournante et d'un kit d'attache pour bâche. Cet enrouleur est livré en un seul colis, packaging couleur.

**Cover roller for inground pools**

Winder cover for in ground pools. Unfolds to a maximum length of 5.50 m. Suitable for round, square or oval swimming pools. Includes round anodised aluminium tubes, an ergonomic hand wheel with revolving handle as well as a kit to attach it to the cover.

**Avvolgitore per piscine interrate**

Avvolgitore "grandi ruote" per piscine interrate. Si srotola fino a un massimo di 5.50m. Adatto per le piscine tonde, quadrate e ovali. Contiene un tubo in alluminio anodizzato, una ghiera ergonomica con una impugnatura rotatoria e un kit per fissare la copertura. Consegnato in un unico imballo.

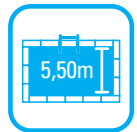

REF. 90172

BXL PACK 1



**Enrollador de cubierta para piscinas enterradas**

Ofrece un desarrollo máximo de 5,50m. Ideal para piscinas redondas, cuadradas u ovaladas. Contiene tubos redondos en aluminio, un volante ergonómico con empuñadura giratoria así como un kit para atar la cubierta.

**Enrouleur de bâche pour piscines enterrées**

Il offre un développement maximum de 5,50m. Il convient aux piscines rondes, carrées ou ovales. Il est équipé de tubes ronds en aluminium, d'un volant ergonomique avec poignée tournante et d'un kit d'attache pour bâche. Cet enrouleur est livré en un seul colis, packaging couleur.

**Cover roller for inground pools**

Unfolds to a maximum length of 5.50 m. Suitable for round, square or oval swimming pools. Includes round aluminium tubes, an ergonomic hand wheel with revolving handle as well as a kit to attach it to the cover.

**Avvolgitore di copertura per piscine interrate**

Si srotola fino a un massimo di 5.50m. Adatto per le piscine tonde, quadrate e ovali. Contiene un tubo in alluminio, una ghiera ergonomica con una impugnatura rotatoria e un kit per fissare la copertura. Consegnato in un unico imballo.

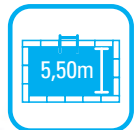

# complementos complements



REF. 40135

CBX PACK 2



### Enrollador piscinas elevadas

El Enrollador ofrece un desarrollo máximo de 6,5m. Se ata fácilmente a las "playas" de la piscina con 2 placas atornilladas. El uso del enrollador permite una mejor conservación de la cubierta. Incluido: Conectores para piscinas tubulares.

### Cover roller for above-ground pools

The Winder unfolds to a maximum length of 6.5 m. It can be easily attached to the "edge" finishing pieces of the pool using 2 bolted plates. The use of the winder enables a better conservation of the cover. Included: Connectors for tubular pools.

### Enrouleur pour piscines hors-sol

Enrouleur offrant un développement maximum de 6,5m. Il se fixe facilement sur les 2 "margelles" de la piscine grâce à ses 2 plaques vissées. L'utilisation de l'enrouleur permet de conserver la bâche dans de bonnes conditions. Inclus: Connecteurs pour piscines tubulaires.

### Avvolgitore per piscine fuoritera

Avvolgitore che si srotola fino a un massimo di 6.5 m. Si fissa facilmente alla "bordo" della piscina con 2 placche con viti. L'utilizzo dell'avvolgitore permette una migliore conservazione della copertura.



REF. 621535

BXL PACK 1



### Enrollador piscinas elevadas Luxe

Enrollador para piscina en superficie de longitud entre 2,44 y 6,32 m. Giro sobre el eje para descubrir la superficie de nado. Travesaño de resina. Sistema de enganche compatible con todas las lonas de verano. Tubos telescópicos de aluminio 3 tubos de 76 mm y 2 tubos de 80 mm. Cinchas de enganche.

### Luxe cover roller for above-ground pools

Roller for pool surface between 2.44 and 6.32 m long. It turns on its axis to reveal the swimming surface. Resin cross member. Hook system compatible with all the summer canvases. Telescopic aluminium tubes: 3 x 76 mm tubes and 2 x 80 mm tubes. Webbing loop.



### Enrouleur pour piscines hors-sol Luxe

Enrouleur pour piscine hors sol d'une largeur de 2,44 à 6,32 m. Pivote sur un axe pour libérer la surface de nage. Piètement en résine. Système d'accroche compatible avec toutes les bâches été. Tubes télescopiques en aluminium : 3 tubes de 76 mm et 2 tubes de 80 mm. Sangles d'accrochage.

### Avvolgitore per piscine fuori terra Luxe

Avvolgitore per piscine fuori terra di lunghezza compresa tra 2,44 e 6,32 m. Ruotare sull'asse per scoprire la superficie di balneazione. Traversa in resina. Sistema di aggancio compatibile con tutti i tessuti estivi. Tubi telescopici in alluminio 3 tubi da 76 mm e 2 tubi da 80 mm. Cinghie di aggancio.

**LINERS PARA PISCINA DE MADERA WOODEN POOL LINERS**  
**LINERS POUR PISCINES BOIS LINERS PER PISCINE IN LEGNO**



Liner azul (AZ)  
 Blue liner (AZ)  
 Liner bleu (AZ)  
 Liner blu (AZ)



Liner beige (BE)  
 Beige liner (BE)  
 Liner beige (BE)  
 Liner beige (BE)



Sistema colgante  
 Hanging system  
 Système d'accroche  
 Con barra di agganciamento



EAN 13

783885	AZ	Ø 511	124cm	75/100	3 605217 838858
786214	BE				3 605217 862143
778689	AZ	Ø 412	119cm	50/100	3 605217 786890
786213	BE				3 605217 862136
786329	AZ	Ø 295	119cm	50/100	3 605217 863294
786337	AZ	942x592	146cm	75/100	3 605217 863379
786219	BE				3 605217 862198
786336	AZ	872x472	146cm	75/100	3 605217 863362
786218	BE				3 605217 862181
786334	AZ	672x472	146cm	75/100	3 605217 863348
786217	BE				3 605217 862174
783809	AZ	637x412	133cm	75/100	3 605217 838094
786216	BE				3 605217 862167
778768	AZ	551x351	119cm	60/100	3 605217 787682
786215	BE				3 605217 862150
778767	AZ	436x336	119cm	60/100	3 605217 787675
785943	AZ	800x400	146cm	75/100	3 605217 859433
785939	AZ	600x400	133cm	75/100	3 605217 859396
785945	AZ	400x250	119cm	75/100	3 605217 859457
788044	AZ	300x300	119cm	60/100	3 605217 880444

## LINERS LINERS LINERS LINERS



Liner azul (AZ)  
Blue liner (AZ)  
Liner bleu (AZ)  
Liner blu (AZ)



Liner gresite (GR)  
Ceramics liner (GR)  
Liner carrelage (GR)  
Liner mosaicato (GR)



Sistema colgante (SC)  
Hanging system (SC)  
Système d'accroche (SC)  
Con barra di agganciamento (SC)



Sistema overlap (OV)  
Overlap system (OV)  
Système à recouvrement (OV)  
Sistema overlap (OV)

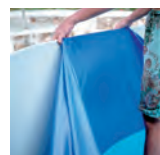

EAN 13

FPR557	GR	SC	Ø 550	132cm	50/100	8 4 1 2 0 8 1 2 5 8 2 4 9
FPR558	AZ				40/100	8 4 1 2 0 8 1 2 1 4 5 0 4
FPR551		120cm	40/100	8 4 1 2 0 8 1 9 5 0 6 4 8		
770398		OV	120cm	75/100	3 6 0 5 2 1 7 7 0 3 9 8 9	
FPR457	GR	SC	Ø 460	132cm	50/100	8 4 1 2 0 8 1 2 5 8 2 5 6
FPR458	AZ				40/100	8 4 1 2 0 8 1 2 2 4 1 2 1
FPR451					120cm	40/100
FSP450	AZ	OV	Ø 450	90cm	20/100	8 4 1 2 0 8 1 9 9 0 2 1 7
FSP400			Ø 400	90cm	20/100	8 4 1 2 0 8 1 9 9 0 2 2 4
FPR357	GR	SC	Ø 350	132cm	50/100	8 4 1 2 0 8 1 2 5 8 2 6 3
FPR358	AZ	SC		132cm	40/100	8 4 1 2 0 8 1 2 3 3 9 1 8
FPR352				120cm	40/100	8 4 1 2 0 8 1 2 0 0 5 7 6
FPR354				90cm	30/100	8 4 1 2 0 8 1 2 0 1 1 7 7
FSP350				OV	90cm	20/100
FPR301	AZ	SC	Ø 300	120cm	40/100	8 4 1 2 0 8 1 2 1 6 0 2 7
FSP300		OV		90cm	20/100	8 4 1 2 0 8 1 2 0 3 2 4 9
FWPR30				65cm	20/100	8 4 1 2 0 8 1 2 0 1 1 9 1
FPR241		SC	Ø 240	120cm	40/100	8 4 1 2 0 8 1 2 0 3 0 1 0

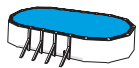

**EAN 13**

<b>FPROV1028</b>	AZ	SC	1000x550	132cm	40/100	 8 412081 224169
<b>FPROV917</b>	GR	SC	915x470	132cm	50/100	 8 412081 258195
<b>FPROV918</b>	AZ	SC		132cm	40/100	 8 412081 214511
<b>FPROV915</b>			120cm	40/100	 8 412081 980270	
<b>FPROV827</b>	GR	SC	800x470	132cm	50/100	 8 412081 258201
<b>FPROV818</b>	AZ	SC		132cm	40/100	 8 412081 224091
<b>FPROV810</b>			120cm	40/100	 8 412081 206059	
<b>FPROV737</b>	GR	SC	730x375	132cm	50/100	 8 412081 258218
<b>FPROV738</b>	AZ	SC		132cm	40/100	 8 412081 224107
<b>FPROV730</b>				120cm	40/100	 8 412081 980287
<b>770399</b>	AZ	OV	730x370	120cm	75/100	 3 605217 703996
<b>FPROV617</b>	GR	SC	610x375	132cm	50/100	 8 412081 258225
<b>FPROV618</b>	AZ	SC		132cm	40/100	 8 412081 224114
<b>FPROV610</b>				120cm	40/100	 8 412081 206066
<b>773486</b>	AZ	OV	610x370	120cm	75/100	 3 605217 734860
<b>FPROV5171</b>	GR	SC	500x350	132cm	50/100	 8 412081 268767
<b>FPROV5071</b>	AZ			120cm	40/100	 8 412081 268750
<b>FPROV517</b>	GR	SC	500x300	132cm	50/100	 8 412081 258232
<b>FPROV500</b>	AZ			120cm	40/100	 8 412081 221878

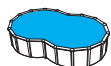

**EAN 13**

<b>FPROV707</b>	AZ	SC	700x450	120cm	40/100	 8 412081 204338
<b>FPROV627</b>	AZ	SC	625x375	120cm	40/100	 8 412081 204345
<b>FPROV507</b>	AZ	SC	500x310	120cm	40/100	 8 412081 204352

## PROTECTORES PROTECTORS PROTECTEURS PROTEZIONE

### FLOOR PROTECTOR - SPECIAL SPA

REF. MPF819GY PB PACK 8 50x50cmx8mm 8 412081 302638



#### PROTECTOR DE SUELO DE PISCINA

Material duradero (Etilvinilacetato (EVA))  
Ofrece una protección adicional para el fondo de la piscina  
Contiene 9 piezas de 50x50cm = 2,25m<sup>2</sup>

#### PROTECTEUR DE SOL DE PISCINE

Matériau durable (Éthylène-acétate de vinyle (EVA))  
Fournit une protection supplémentaire pour les sols de piscines  
L'emballage contient 9 pièces 50x50cm = 2,25m<sup>2</sup>

#### POOL FLOOR PROTECTOR

Durable material (Ethylene-vinyl acetate (EVA))  
Provides added protection for pool floors  
Package contains 9 pieces of 50x50cm = 2,25m<sup>2</sup>

#### PROTEZIONE PER IL FONDO DELLA PISCINA

In materiale resistente (Etilene vinil acetato (EVA))  
Evita che il fondo della piscina si danneggi  
Il package include 9 pezzi, 50x50cm = 2,25m<sup>2</sup>

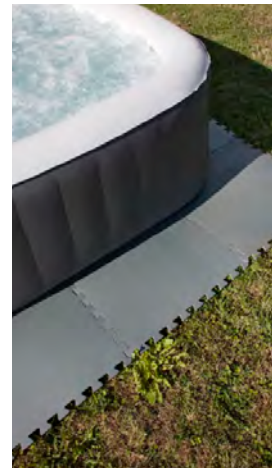

### FLOOR PROTECTOR

REF. MPF819 PB PACK 7 81x81cmx4,5mm 8 412081 268361

#### PROTECTOR DE SUELO DE PISCINA

Material duradero (Etilvinilacetato (EVA))  
Ofrece una protección adicional para el fondo de la piscina  
Contiene 9 piezas de 81x81cm = 5,90m<sup>2</sup>

#### PROTECTEUR DE SOL DE PISCINE

Matériau durable (Éthylène-acétate de vinyle (EVA))  
Fournit une protection supplémentaire pour les sols de piscines  
L'emballage contient 9 pièces 81x81cm = 5,90m<sup>2</sup>

#### POOL FLOOR PROTECTOR

Durable material (Ethylene-vinyl acetate (EVA))  
Provides added protection for pool floors  
Package contains 9 pieces of 81x81cm = 5,90m<sup>2</sup>

#### PROTEZIONE PER IL FONDO DELLA PISCINA

In materiale resistente (Etilene vinil acetato (EVA))  
Evita che il fondo della piscina si danneggi  
Il package include 9 pezzi, 81x81cm = 5,90m<sup>2</sup>

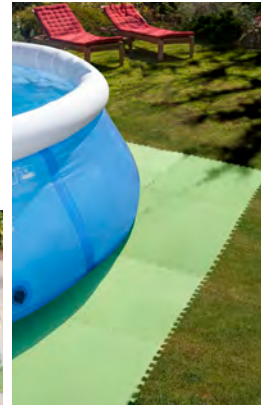

### FLOOR PROTECTOR

REF. MPF509GR PB PACK 8 50x50cmx8mm 8 412081 268521

#### PROTECTOR DE SUELO DE PISCINA

Material duradero (Etilvinilacetato (EVA))  
Ofrece una protección adicional para el fondo de la piscina  
Contiene 9 piezas de 50x50cm = 2,25m<sup>2</sup>

#### PROTECTEUR DE SOL DE PISCINE

Matériau durable (Éthylène-acétate de vinyle (EVA))  
Fournit une protection supplémentaire pour les sols de piscines  
L'emballage contient 9 pièces 50x50cm = 2,25m<sup>2</sup>

#### POOL FLOOR PROTECTOR

Durable material (Ethylene-vinyl acetate (EVA))  
Provides added protection for pool floors  
Package contains 9 pieces of 50x50cm = 2,25m<sup>2</sup>

#### PROTEZIONE PER IL FONDO DELLA PISCINA

In materiale resistente (Etilene vinil acetato (EVA))  
Evita che il fondo della piscina si danneggi  
Il package include 9 pezzi, 50x50cm = 2,25m<sup>2</sup>

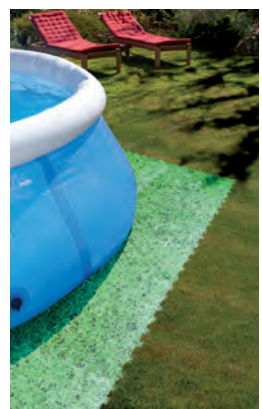
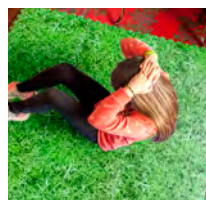

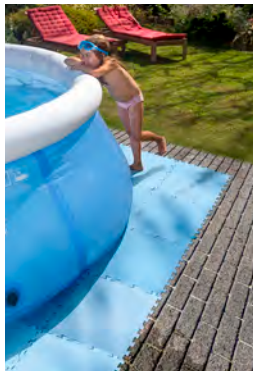

### FLOOR PROTECTOR

REF. MPF509

PB PACK 14

50x50cmx4,5mm



#### PROTECTOR DE SUELO DE PISCINA

Material duradero (Etilvinilacetato (EVA)) Ofrece una protección adicional para el fondo de la piscina  
Contiene 9 piezas de 50x50cm = 2,25m<sup>2</sup>

#### PROTECTEUR DE SOL DE PISCINE

Matériau durable (Éthylène-acétate de vinyle (EVA)) Fournit une protection supplémentaire pour les sols de piscines. L'emballage contient 9 pièces 50x50cm

#### POOL FLOOR PROTECTOR

Durable material (Ethylene-vinyl acetate (EVA)) Provides added protection for pool floors. Package contains 9 pieces of 50x50 = 2,25m<sup>2</sup>

#### PROTEZIONE PER IL FONDO DELLA PISCINA

In materiale resistente (Etilene vinil acetato (EVA)) Evita che il fondo della piscina si danneggi. Il package include 9 pezzi, 50x50cm



### BOX MPF509

REF. MPF509BOX60

PB PACK 60

50x50cmx4,5mm



#### BOX PROTECTOR DE SUELO DE PISCINA

Material duradero (Etilvinilacetato (EVA)) El box contiene 60 unidades

#### BOX PROTECTEUR DE SOL DE PISCINE

Matériau durable (Éthylène-acétate de vinyle (EVA)). L'box contient 60 unités

#### BOX POOL FLOOR PROTECTOR

Durable material (Ethylene-vinyl acetate (EVA)). Box contains 60 units

#### BOX PROTEZIONE PER IL FONDO DELLA PISCINA

In materiale resistente (Etilene vinil acetato (EVA)). Il box include 60 unità

## Delta MS®

REF. 772060

BXL PACK 1

20 x 1,5m



3 605217 720603

### PROTECTOR DE PARED

Rollo de protección y de drenaje alveolar de PEAD (polietileno de alta densidad) para piscina de madera  
1- Pared de piscina de madera  
2- Rollo de protección y de drenaje alveolar de PEAD

### ROULEAU DE PROTECTION

Pour piscine bois  
Rouleau de protection et de drainage alvéolaire en PEHD (polyéthylène haute densité).  
1 - Ossature bois  
2 - Nappe à excroissances type Delta MS®

### WALL PROTECTOR

Protection and alveolar draining roll of HDPE ( High Density Polyethylene) for wooden pool  
1- Wood frame  
2- Roll of alveolar protection an drainage of HDPE

### PROTEZIONE PER PARETE

Rotolo di protezione del drenaggio alveolare di HDPE (polietilene ad alta densità) per piscina in legno  
1- Struttura in legno  
2- Rotolo di protezione del drenaggio alveolare di HDPE

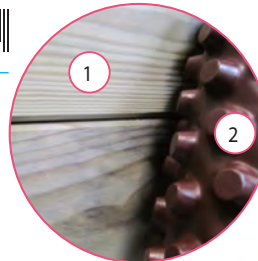

## POOL HOUSE

REF. PH54

CBX PACK 1

5,00 x 4,33 x 2,50 m



8 412081 257532

### TOLDO PISCINA

Dimensiones: 5,00 x 4,33 x 2,50 m  
Material: Poliéster  
Paneles laterales de PVC transparente  
3 puertas con cierre de cremallera

### AUVENT DE PROTECTION

Dimensions : 5,00 x 4,33 x 2,50 m  
Matériau : Polyester  
Parois latérales en PVC transparent  
3 portes avec fermeture éclair

### POOL HOUSE

Assembled size: 5,00 x 4,33 x 2,50 m  
Material: Polyester. Transparent PVC side walls. 3 doors with zipper close. Adaptable to 4m pools.

### GAZEBO DI PROTEZIONE

Dimensioni: 5,00 x 4,33 x 2,50 m  
Materiale: Poliestere  
Pannelli laterali in PVC trasparente  
3 porte con chiusura a zip



**REPARADORES DE LINER LINER REPAIR**  
**RÉPARATION LINER RIPARAZIONE LINER**

REF. 40080

BL PACK 24 DIS



Kit reparación liner  
 Kit réparation liner

Liner repair kit  
 Kit riparazione liner



REF. V12

BL PACK 50



Kit reparador de PVC  
 Kit réparation PVC

PVC repair kit  
 Kit per riparazioni PVC



REF. AR202

BL PACK 96



Film reparador de PVC  
 Film réparation PVC

PVC repair film  
 Pellicola per riparare i liner



**ESCALERAS PARA PISCINA ENTERRADA INGROUND POOL LADDERS**  
**ÉCHELLES POUR PISCINES ENTERRÉES SCALETTA PER PISCINA INTERRATA**



REF. EIE30

BXL PACK 1



Escalera acero inoxidable AISI304 para piscina enterrada  
3 peldaños dobles

AISI304 Stainless steel inground pool ladder  
3 double steps

Échelle acier inoxydable AISI304 pour piscine enterrée  
3 marches double

Scaletta Inox AISI304 per piscina interrata  
3 gradini doppi



Ref. EPE30

BXL PACK 1



Escalera sintética para piscinas enterradas  
4 peldaños

Easy access synthetic ladder for in ground pools  
4 steps

Échelle synthétique d'entrée facile pour piscine enterrée  
4 marches

Scaletta sintetica per piscina interrata  
4 gradini



**STANDARD**

REF. 40272

BXL PACK 1



Escalera STANDARD para piscina enterrada de 4 peldaños Inox.

Stainless steel STANDARD inground pool ladder - 4 steps.

Échelle modèle STANDARD acier inoxydable pour piscine enterrée - 4 marches

Scaletta STANDARD per piscina interrata da 4 gradini - Inox



**STANDARD**

REF. 40110

BXL PACK 1



Escalera STANDARD para piscina enterrada de 3 peldaños Inox.

Stainless steel STANDARD inground pool ladder - 3 steps.

Échelle modèle STANDARD acier inoxydable pour piscine enterrée - 3 marches

Scaletta STANDARD per piscina interrata da 3 gradini - Inox

**WALL**

REF. 40274

BXL PACK 1



Escalera MURO para piscina enterrada de 4 peldaños – Inox

Échelle MURALE acier inoxydable pour piscine enterrée - 4 marches

Stainless steel inground pool WALL ladder - 4 steps

Scaletta MURO per piscina interrata da 4 gradini – Inox



**WALL**

REF. 40273

BXL PACK 1



Escalera MURO para piscina enterrada de 3 peldaños – Inox

Échelle MURALE acier inoxydable pour piscine enterrée - 3 marches

Stainless steel inground pool WALL ladder - 3 steps

Scaletta MURO per piscina interrata da 3 gradini – Inox

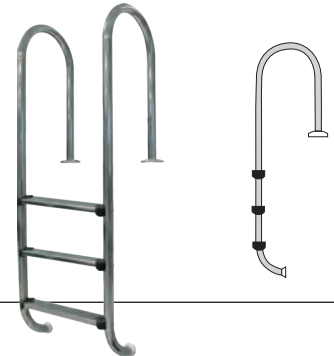

**ESCALERA PARA PISCINA DE MADERA WOODEN POOL LADDER**  
**ÉCHELLE POUR PISCINES BOIS SCALETTA PER PISCINE IN LEGNO**

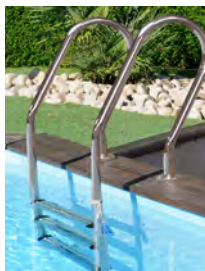

Ref. 126674

CBX PACK 1



Escalera de acero inoxidable partida 3 peldaños antideslizantes  
 Para piscinas de madera

Échelle en acier inoxydable 2 éléments.  
 3 marches antidérapantes.  
 Pour piscines en bois.

Split stainless steel ladder  
 3 non-slip steps  
 For wooden pools

Scaletta in acciaio inox a due elementi  
 3 gradini antiscivolo  
 Per piscine in legno



**ESCALERAS PARA PISCINA SOBRE SUELO ABOVE-GROUND POOL LADDERS**  
**ÉCHELLES POUR PISCINES HORS SOL SCALETTA PER PISCINA FUORI TERRA**



**INOX**

REF. AR11680

BXL PACK 1



Escalera de acero inoxidable 142cm  
2x4 peldaños + plataforma

Échelle acier inoxydable 142cm  
2x4 marches + plateforme

Stainless steel ladder 142cm  
2x4 steps + platform

Scala in acciaio inossidabile 142cm  
2x4 gradini + piattaforma



120cm  
132cm



**SAFETY**

REF. ES1213

BXL PACK 1



Escalera de seguridad  
2x3 peldaños + plataforma

Échelle sécurité 134cm  
2x3 marches + plateforme

Safety ladder  
2x3 steps + platform

Scala di sicurezza  
2x3 gradini + piattaforma



120cm  
132cm



REF. ET1213

BXL PACK 1



Escalera de seguridad  
2x3 peldaños

Échelle sécurité  
2x3 marches

Safety ladder  
2x3 steps

Scala di sicurezza  
2x3 gradini



**STANDARD**

REF. AR109

BXL PACK 1



Escalera tipo tijera 98cm  
2x2 peldaños

Échelle 98cm  
2x2 marches

Ladder 98cm  
2x2 steps

Scala 98cm  
2x2 gradini



**SPA LADDER**

REF. SPAL2

BXL PACK 1



Escalera para SPA  
2 peldaños

Marche pied pour SPA  
2 marches

SPA Ladder  
2 steps

Scala per SPA  
2 gradini



70x65x34cm



## FILTROS DE ARENA SAND FILTERS FILTRE A SABLE FILTRO A SABBIA

Las impurezas quedan retenidas en el medio filtrante en el interior de la cuba. Son muy compactos, fáciles de instalar, utilizar y no requieren especial atención. Incorporan un prefiltro para retener las partículas excesivamente grandes y evitar dañar la bomba. Gracias a su válvula selectora (5/6 vías dependiendo del modelo), permiten realizar diferentes funciones: autolimpiado, filtración, vaciado... Los filtros FA6100 / FS500 / FS400 / FS320 están certificado con la norma europea EN 16713-1:2015 que garantiza que cumple con las normativas de seguridad establecidas.

Impurities are held by the filter media inside the tank. Sand filters are compact sized, easy to install and use and special care is not required. They include a prefilter to hold the largest particles to prevent pump from any damage. Thanks to their multiport valves (5/6 ways depending on the version), different functions can be carried out: self-cleaning, filtration, emptying... Filters FA6100 / FS500 / FS400 / FS320 are certified with the standard europe EN 16713-1:2015 ensuring that they comply with the safety regulations set.



REF. FA6100



REF. FS500



REF. FS400



NEW

REF. FS320



W

HP



EAN 13

<b>FA6100</b>	Ø 600 mm	10.000 l/h	485 W	0,66 CV/HP	±130 kg	6	BXL pack 1	
<b>FS500</b>	Ø 500 mm	8.000 l/h	550 W	0,75 CV/HP	±85 kg	5	BXL pack 1	
<b>FS400</b>	Ø 400 mm	6.000 l/h	230 W	0,31 CV/HP	±40 kg	5	BXL pack 1	
<b>FS320</b>	Ø 320 mm	4.000 l/h	180 W	0,24 CV/HP	±28 kg	5	BXL pack 1	

# compléments **complementi**

Les impuretés sont retenues dans le média filtrant à l'intérieur de la cuve. Ces filtres sont très compacts et très faciles à installer et à utiliser, sans grandes exigences. Le filtre est muni d'un pré filtre qui retient les particules excessivement grandes pour éviter d'endommager la pompe. Sa vanne multivoie (5/6 voies, suivant le modèle), permet de réaliser diverses fonctions: auto nettoyage, filtrage, vidange... Les filtres FA6100 / FS500 / FS400 / FS320 est certifié par la norme européenne EN 16713-1:2015 garantissant qu'ils respectent les réglementations établies en matière de sécurité.







Le impurità rimangono intrappolate nelle carico filtrante all'interno del cestello. Sono molto compatti, facili da installare e da utilizzare e non richiedono cure particolari. Sono composti da un prefiltro per trattenere le particelle eccessivamente grandi ed evitare il danneggiamento della pompa(\*). Grazie alla valvola selettiva della quale sono dotati (5/6/7 uscite a seconda del modello), consentono diverse funzioni: autopulizia, filtrazione, svuotamento... Il filtri FA6100 / FS500 / FS400 / FS320 sono certificati dalla normativa europea EN 16713-1:2015 che garantisce la loro conformità alle normative di sicurezza vigenti.



Ref. 777619  
777620  
777621  
777622



🇫🇷 Références exclusives pour la France

	Ø de la cuve	Débit	W	Puissance	Sand	Valve top		EAN 13
<b>770803</b>	Ø 300 mm	4.000 l/h	220 W	0,25 CV	±19 kg	4	<b>CBX pack 1</b>	 3 605217 708038
<b>777619</b>	Ø 400 mm	6.000 l/h	550 W	0,50 CV	±45 kg	6	<b>BXL pack 1</b>	 3 605217 776198
<b>777620</b>	Ø 485 mm	8.000 l/h	600 W	0,75 CV	±75 kg	6	<b>BXL pack 1</b>	 3 605217 776204
<b>777621</b>	Ø 485 mm	12.000 l/h	1000 W	1,00 CV	±75 kg	6	<b>BXL pack 1</b>	 3 605217 776211
<b>777622</b>	Ø 610 mm	16.000 l/h	1100 W	1,50 CV	±125 kg	6	<b>BXL pack 1</b>	 3 605217 776228

# complementos complements

## BOMBAS PUMPS POMPES POMPE

Gama de bombas autoaspirantes GRE con potencias comprendidas entre 1/3 CV y 2 CV. Se trata de bombas centrifugas de una sola etapa, autocebantes, concebidas para uso con un sistema de filtración de piscina.

Gamme de pompes autoaspirantes GRE, avec des puissances comprises entre 1/3 CV et 2 CV. Il s'agit de pompes centrifuges, auto-amorçantes, conçues pour une utilisation avec un système de filtration de piscine.

The self-priming pump range GRE emits power between 1/3 CV and 2 CV. Centrifugal pumps are single stage, self-priming pumps designed for use in a swimming pool filtration systems.

Gamma di pompe autoaspiranti GRE con potenze comprese tra 1/3 CV e 2 CV. Si tratta di pompe centrifughe monostadio, autoadescenti, concepite per l'uso con un sistema di filtrazione per piscina.

### PREMIUM

- Ref. PP201 CBX PACK 1
- Ref. PP151 CBX PACK 1
- Ref. PP101 CBX PACK 1
- NEW Ref. PP076H CBX PACK 1



Curvas de rendimiento hidráulico  
Hydraulic performance curves  
Courbes de performances hydrauliques  
Curve delle prestazioni idrauliche

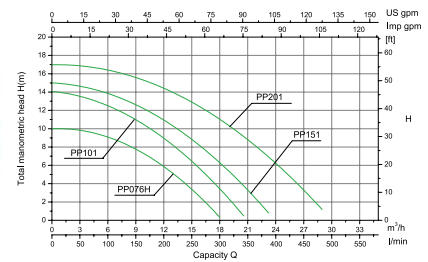

### COMFORT

- Ref. PP076 CBX PACK 1
- Ref. PP051 CBX PACK 1
- Ref. PP031 CBX PACK 1



Curvas de rendimiento hidráulico  
Hydraulic performance curves  
Courbes de performances hydrauliques  
Curve delle prestazioni idrauliche

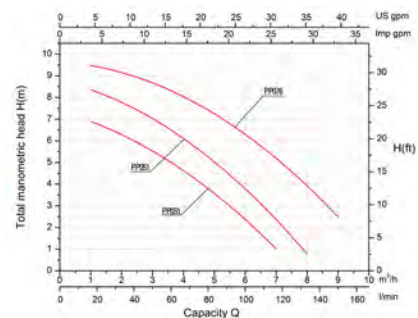

HP

W



EAN 13

Model	HP	W	Flow (l/h)	Capacity (m³)	Ø (mm)	EAN 13
PP201	2 CV/HP	1600 W	27.000 l/h	170m³	Ø 800 mm	8 412081 269535
PP151	1,5 CV/HP	1100 W	22.000 l/h	135m³	Ø 700 mm	8 412081 269542
PP101	1 CV/HP	900 W	20.000 l/h	100m³	Ø 600 mm	8 412081 269559
NEW PP076H	3/4 CV/HP	550 W	17.000 l/h	65m³	Ø 500 mm	8 412081 302737
PP076	3/4 CV/HP	550 W	9.500 l/h	65m³	Ø 500 mm	8 412081 269566
PP051	1/2 CV/HP	450 W	8.500 l/h	50m³	Ø 400 mm	8 412081 269573
PP031	1/3 CV/HP	250 W	7.000 l/h	35m³	Ø 300 mm	8 412081 269580



**FILTROS AQUALOON AQUALOON FILTER**  
**FILTRATION AQUALOON FILTRO MONOBLOCCO**



**FILTRO AQUALOON**

REF. FAQ200

CBX PACK 1



FILTRO AQUALOON  
 Tanque 200 mm. Caudal: 4m<sup>3</sup>/h.  
 Filtra cualquier residuo hasta 3 micras.  
 Conexiones 32 y 38 mm.  
 Incluye 320g de Aqualoon

AQUALOON FILTER  
 200 mm tank. Flow rate: 4m<sup>3</sup>/h.  
 Filters any residue until 3 micron.  
 32 and 38 mm connections.  
 Include 320g Aqualoon

MOYEN DE FILTRATION  
 Cuve 200 mm. Débit 4m<sup>3</sup>/h.  
 Filtre n'importe quel résidu jusqu'à 3 microns. Embouts soudés 32 et 38 mm.  
 Comprend 320g Aqualoon

SISTEMA FILTRANTE  
 Filtro 200 mm. Portata 4m<sup>3</sup>/h.  
 Filtra qualsiasi residuo fino a 3 micron  
 Raccordi 32 e 38 mm.  
 Include 320g di Aqualoon



**FILTRO AQUALOON**

REF. CFAQ35

CBX PACK 1



FILTRO DE CARTUCHO CON AQUALOON  
 Caudal: 3,5m<sup>3</sup>/h.  
 Filtra cualquier residuo hasta 3 micras.  
 Conexiones 32 y 38 mm.

CARTRIDGE FILTER WITH AQUALOON  
 Flow rate: 3,5m<sup>3</sup>/h.  
 Filters any residue until 3 micron.  
 32 and 38 mm connections.

EPURATEUR À CARTOUCHE AVEC AQUALOON  
 Débit 3,5m<sup>3</sup>/h.  
 Filtre n'importe quel résidu jusqu'à 3 microns. Embouts soudés 32 et 38 mm.

FILTRI A CARTUCCIA  
 Portata 3,5m<sup>3</sup>/h.  
 Filtra qualsiasi residuo fino a 3 micron  
 Raccordi 32 e 38 mm.

**MEDIOS FILTRANTES FILTER MEDIA**  
**MÉDIAS FILTRANTS CARICO FILTRO**



**AQUALOON**

REF. AQ700

CBX PACK 36



REF. AQ700B



CBX PACK 12



MEDIO FILTRANTE  
 700gr de AQUALOON = 25kg de ARENA  
 Filtra cualquier residuo hasta 3 micras  
 Polietileno 100% reciclable

FILTER MEDIA  
 700gr AQUALOON = 25kg SAND  
 Filters any residue up to 3 microns  
 Polyethylene 100% recyclable

MOYEN DE FILTRATION  
 700g d'AQUALOON = 25kg de SABLE  
 Filtre n'importe quel résidu jusqu'à 3 microns  
 Polyéthylène 100% recyclable

SISTEMA FILTRANTE  
 700gr de AQUALOON = 25kg de ARENA  
 Filtra qualsiasi residuo fino a 3 micron  
 Polietilene riciclabile al 100%.

## LOCALES TÉCNICOS TECHNICAL ROOMS LOCAL TECHNIQUE LOCALE TECNICO



DESIGNED,  
MACHINED  
AND  
ASSEMBLED  
IN EU



### TECHNICAL ROOM

BXL PACK 1

#### LOCAL TÉCNICO

Pino silvestre autoclave clase III.  
Paneles pre-ensamblados para montaje por usted mismo. Para todos los tipos de piscinas. Abertura superior mediante trampilla. Para adosar a la piscina o a una pared (con fondo).  
L. 100 x a. 88 cm - 3 alturas disponibles.

#### LOCAL TECHNIQUE

En pin Sylvestre autoclave classe III.  
Panneaux pré-assemblés, à monter soi-même. Pour tous types de piscines. Ouverture sur le dessus par une trappe. à adosser à la piscine ou à un mur (avec fond). L. 100 x l. 88 cm - 3 hauteurs disponibles.

#### TECHNICAL ROOM

Autoclave class III pine.  
Pre-assembled panels for you to assemble yourself. For all types of swimming pools.  
Top opening through a flap.  
To fit to a pool or to a wall (with a base).  
L 100 x h 88 cm - 3 heights available.

#### LOCALE TECNICO

Pino silvestre trattamento in autoclave classe III. Pannelli pre-assemblati che è possibile montare da soli. Per tutti i tipi di piscina. Apertura superiore mediante botola. Da appoggiare alla piscina o a una parete (con fondo).  
L. 100 x a. 88 cm - 3 altezze disponibili.

Ref. 787247  
H. 118cm



3 605217 872470

Ref. 787248  
H. 131cm



3 605217 872487

Ref. 787249  
H. 143cm



3 605217 872494



DESIGNED,  
MACHINED  
AND  
ASSEMBLED  
IN EU



REF. TRCP124

BXL PACK 1



3 605217 872494

#### LOCAL TÉCNICO

Local técnico para piscinas de composite en paneles premontados. Cadenado incluido (para la seguridad de los niños).  
Mismo diseño y acabado que las piscinas de composite.

#### LOCAL TECHNIQUE

Local technique pour piscines en composite et panneaux pré-montés. Cadenas inclus (pour la sécurité des enfants).  
Même style et finition que les piscines en composite.

#### TECHNICAL ROOM

Composite technical room which consists of pre-mounted panels. A lock is included (as childrens security).  
Same design and finish as the composite pools.

#### LOCALE TECNICO

Locale tecnico per piscine in materiale composito a pannelli premontati. Lucchetto incluso (per la sicurezza dei bambini).  
Design e finitura identiche a quelle della piscina in materiale composito.

**MEDIOS FILTRANTES FILTER MEDIA**  
**MÉDIAS FILTRANTS CARICO FILTRO**



REF. AR200

PB PACK 1



Arena - Silex 25kg.  
Granulometría 0,4-0,8.  
Sable - Silex 25kg.  
Granulométrie 0,4-0,8.

Sand - Silex 25 kg.  
Grain size 0,4-0,8.  
Sabbia - Silex 25kg.  
Granulometria 0,4-0,8.



REF. VF025

PB PACK 1



Vidrio filtrante saco 25kg  
Granulometría 0,5 - 1 mm  
Verre filtrant 25kg  
Granulométrie 0,5 - 1 mm

Glass filter media 25 kg  
Grain size 0,5 - 1 mm  
Vetro filtrante 25kg  
Granulometria 0,5 - 1 mm



Ref. 622564

Palette de 40 sacs



**Sable pour Filtration Sac de sable - 25 Kg**

Origine France  
Granulométrie : 0,5 à 2 mm  
Sable séché

Remplir la cuve au 3/4 maximum

Compatible avec tout type de traitement des eaux de piscine, y compris la floculation  
Il est conseillé de renouveler le sable tous les 3 ans

Référence exclusives pour la France

## MANGUERAS DE FILTRACIÓN FILTRATION HOSES TUYAUX POUR ÉPURATEURS TUBI DI FILTRAZIONE

Kit mangueras filtración  
Kit tuyaux pour épurateurs

Filtration hoses kit  
Kit tubi di filtraggio

2 ( Ø38mm x 4,5m) + 1 ( Ø38mm x 1,5m) + 1 ( Ø38mm x 0,68m) + 1 ( Ø38mm x 0,58m)  
+ 1 ( Ø38mm x 0,40m) + 7 abrazaderas / clamps / colliers / fascette

REF. AR2100

BX PACK 1



Manguera seccionable 36,5m  
Tuyau sectionnable 36,5m

Sectionable hose 36,5m  
Tubo sezionabile 36,5m

Ø38mm

REF. 90160

BX PACK 1



Ø32mm

REF. 90161

BX PACK 1



Manguera para filtro 4m  
con 2 terminales  
Tuyau pour filtration 4m  
avec 2 embouts

Filter hose 4m  
with 2 cuffs  
Tubo filtrante 4m  
con 2 terminali

Ø38mm

REF. 40180

BX pack 1



Ø32mm

REF. 40181

BX pack 1



Manguera de conexión  
Tuyau de jonction

Connection hose  
Tubo di giunzione

68 cm - Ø38mm

REF. 60222

PB pack 10



58 cm - Ø38mm

REF. 60218

PB pack 10



36 cm - Ø38mm

REF. 60205

PB pack 10

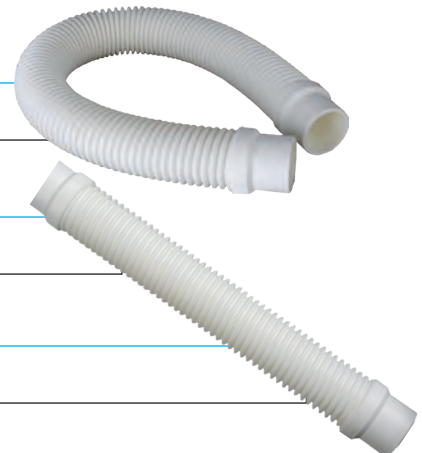

**ADAPTADORES ADAPTERS  
ADAPTEURS ADATTATORI**



Adaptador de mangueras Ø32/38mm    Ø32/38mm hose bard adaptor  
Embout cannelé pour tuyau Ø32/38mm    Adattatore per tubo Ø32/38mm

REF. 778196

BX PACK 12



Quitavueltas para manguera Ø38mm    Ø38mm hose adaptor with threaded connection  
Raccord tournant pour tuyaux Ø38mm    Adattatore per tubo Ø38mm

REF. 40091

BX PACK 30



2 conectores Ø38    2 connectors Ø38  
+ 4 abrazaderas Ø38    + 4 clamps Ø38  
2 manchons pour branchement    2 raccordi Ø38  
tuyaux Ø38 + 4 colliers Ø38    + 4 fascette Ø38

REF. AR509

CS pack 10



2 conectores Ø38/32 +    2 connectors Ø38/32  
4 abrazaderas Ø38/Ø32    + 4 clamps Ø38/ Ø32  
2 manchons pour branchement    2 raccordi Ø38/32 +  
tuyaux Ø38/32 + 4 colliers Ø38/Ø32    4 fascette Ø38/Ø32

REF. AR511

CS pack 10

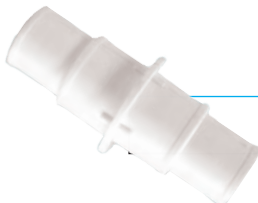

Unión 2 mangueras flotantes    2 vacuum hoses union  
Ø38mm y 32mm    Ø38mm and 32mm  
Liaison pour tuyaux flottants    Raccordo per unire 2 tubi  
Ø38mm et 32mm    Ø32mm – 38mm

REF. 40009

DIS PACK 12



Adaptador de mangueras 38/32mm    38/32mm hose adapter  
Adaptateur de tuyaux Ø38/32mm    Adattatore per tubo 32/38mm

REF. 40095

BX PACK 20



## SKIMMERS PARA PISCINAS DE ACERO STEEL WALL POOLS SKIMMERS SKIMMERS POUR PISCINE PAROI ACIER SKIMMERS PER PISCINA IN ACCIAIO



REF. AR100 BXL PACK 1



Skimmer  
+ boquilla de impulsión  
Skimmer  
+ buse de refoulement

Skimmer  
+ return fitting  
Skimmer  
+ bocchetta



REF. AR100W BXL PACK 1



Skimmer  
+ boquilla de impulsión  
Skimmer  
+ buse de refoulement

Skimmer  
+ return fitting  
Skimmer  
+ bocchetta



REF. AR100G BXL PACK 1



Skimmer  
+ boquilla de impulsión  
Skimmer  
+ buse de refoulement

Skimmer  
+ return fitting  
Skimmer  
+ bocchetta

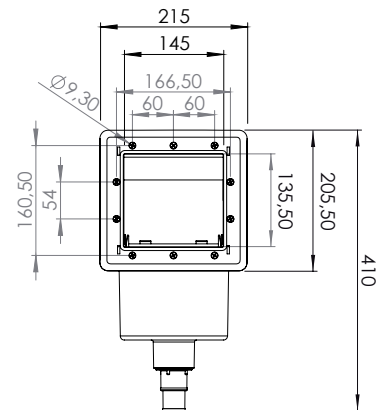

## REPUESTOS DE FILTRACIÓN FILTRATION SPARE PARTS ACCESSOIRES POUR FILTRATION RICAMBI PER FILTRAZIONE



REF. AR500  
CS PACK 6



Cesto para skimmer  
Skimmer Basket  
Panier pour skimmer  
Cesto prefiltro  
Ø ext. 16,2 cm ↑5,5 cm Ø int. 11 cm



REF. AR501  
CS PACK 12



Compuerta para skimmer  
Weir for skimmer  
Volet pour skimmer  
Sportellino  
12 x 14,5 x 2 cm



REF. AR502  
CS PACK 12



Junta doble skimmer  
Skimmer layer  
Joint pour skimmer  
Giunto doppio di stagno  
ext. 20,5 x 19,5 x 0,5 cm  
int. 14,8 x 13,9 x 0,5 cm



REF. AR521  
CS PACK 12



Junta doble skimmer + 2 juntas de  
válvula de retorno  
Double seal for skimmer + 2 seals for  
return valve  
Joint double skimmer + 2 joints  
pour buse de refoulement  
Guarnizione doppia standard Skimmer +  
2 guarnizioni per la valvola di ritorno

# compléments **complementi**



**REF. AR503**  
**CS PACK 6** 8 4 1 2 0 8 1 2 0 6 5 0 9

Boquilla de impulsión  
Return fitting  
Buse de refoulement  
Valvola di impulsione completa



**REF. AR505**  
**CS PACK 8** 8 4 1 2 0 8 1 2 0 8 6 1 9

Tapa para conexión de manguera  
limpiafondos  
Lid for connecting the vacuum  
hose to the skimmer  
Couvercle pour relier le tuyau  
flottant au skimmer  
Adattatore per puliscifondo



**REF. AR506**  
**CS PACK 8** 8 4 1 2 0 8 1 2 0 8 6 0 2

Manómetro  
Pressure gauge  
Manomètre  
Manometro



**REF. AR508**  
**CS PACK 6** 8 4 1 2 0 8 1 2 0 8 5 8 9

Zuncho universal  
Filter ring  
Collier de fixation  
Ghiera filtro



**REF. AR512**  
**CS PACK 12** 8 4 1 2 0 8 1 2 2 1 6 0 1

Válvula apertura/cierre Ø38-Ø32  
Open/close valve Ø38-Ø32  
Vanne ouverture/fermeture Ø38-Ø32  
Valvola di apertura/chisura Ø38-Ø32



**REF. 621702**  
**CBX PACK 1** 3 6 0 5 2 1 6 2 1 7 0 2 9

Válvula cuarto de vuelta  
¼ Turn valve  
Vanne ¼ de tour  
Valvola ¼ di giro



**REF. AR510**  
**CS PACK 24** 8 4 1 2 0 8 1 2 1 5 7 8 5

Cintaflón y 4 abrazaderas  
Cintaflon and 4 clamps  
Teflon et 4 colliers  
Nastro Teflon e 4 fascette



**REF. WFL6**  
**DIS pack 12** 8 4 1 2 0 8 1 2 6 4 4 2 4

Esponjas absorbentes de  
grasa - 6 unidades  
Grease absorbing sponge  
for skimmer - 6 units  
Eponges absorbantes de  
residus gras - 6 unités  
Spugne che assorbe e  
trattiene le sostanze  
grasse - 6 unità

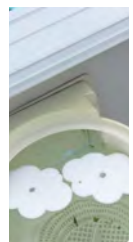

## SKIMMER UNIVERSAL UNIVERSAL SKIMMER SKIMMER UNIVERSEL SKIMMER UNIVERSAL



Ref. 778200

BXL PACK 1



Skimmer de boca ancha para piscina de madera + boquilla de impulsión

Wide mouth skimmer for wooden Pool + return valve

Ensemble skimmer grande ouverture piscine bois + buse de refoulement

Skimmer bocca larga piscina Madera + valvola di ritorno



Ref. 778198

BXL PACK 1



Skimmer universal + boquilla de impulsión

Universal Skimmer + return valve

Ensemble skimmer petite ouverture universel + buse de refoulement

Skimmer universale + valvola di ritorno



Ref. 778193

CS PACK 12



Compuerta para skimmer  
Weir for skimmer  
Volet pour skimmer  
Sportellino



Ref. 625028

CB PACK 1



Tapa para skimmer  
Cover for skimmer  
Couvercle pour skimmer  
Lid per skimmer



Ref. 778194

CS PACK 6



Cesto para skimmer  
Skimmer Basket  
Panier pour skimmer  
Cesto prefiltro  
Dim. Ext. Ø 16cm / Int. Ø 12 cm - H.7,5 cm



Ref. 770359

CS PACK 12



Tapa para conexión de manguera limpiafondos  
Lid for connecting the vacuum hose to the skimmer  
Couvercle pour relier le tuyau flottant au skimmer  
Adattatore per puliscifondo  
Ø 32/38 mm



Ref. FSK10

DIS pack 12



Filtros de skimmer con velcro  
10 unidades  
Prefiltres jetables de skimmer avec velcro. 10 unités.  
Pre-filter fabric bag for use in skimmer using velcro. 10 units.  
Filtri di skimmer con velcro  
10 unità



Ref. 40045

CS PACK 21



10 filtros de skimmer  
10 filter savers  
10 filtres pour skimmer  
10 filtri di skimmer

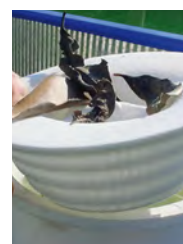



## FILTROS DE CARTUCHO CARTRIDGE FILTER EPURATEUR À CARTOUCHE FILTRI A CARTUCCIA

Están especialmente concebidos para piscinas con un volumen de agua medio-inferior. Son muy sencillos de utilizar y su mantenimiento se limita a la limpieza o sustitución del cartucho o filtro de recambio, cuando éste ha quedado obstruido por la excesiva carga de suciedad.

Ils sont spécialement conçus pour les piscines d'un volume d'eau moyen inférieur. Ils sont très faciles à utiliser et l'entretien se limite au nettoyage ou au remplacement de la cartouche ou du filtre, quand il est bouché par un excès de saletés.

Specially designed for medium-low water volume pools. Cartridge filters are very easy to use and their maintenance is limited to the cartridge cleaning or replacement when dirt is blocking it.

Pensati specialmente per piscine con un volume di acqua medio-basso. Sono molto semplici da usare e la manutenzione si limita alla pulizia o sostituzione della cartuccia o della cartuccia di ricambio, quando questa è ostruita da eccessive impurità.



REF. AR125



REF. AR124  
REF. AR121E



W



EAN 13

AR125	3.800 l/h	70 W	AR82	BXL pack 1	8 4 1 2 0 8 1 9 7 0 3 1 8
AR124	3.800 l/h	70 W	AR82	BXL pack 1	8 4 1 2 0 8 1 2 0 3 1 6 4
AR121E	2.000 l/h	72 W	AR86	BXL pack 1	8 4 1 2 0 8 1 2 1 0 1 9 3

## CARTUCHOS CARTRIDGES CARTOUCHES CARTUCCIA



REF. AR79

Cartucho tipo A piscina autoportante	Type A Cartridge inflatable pool
Cartouche de type A piscine autoportante	Cartuccia tipo A piscina autoportante



REF. AR86

Cartucho	Cartridge
Cartouche	Cartuccia



EAN 13

AR86	AR121/118	CS pack 12	8 4 1 2 0 8 1 2 0 3 4 0 9
AR82	AR125/124/118	CS pack 12	8 4 1 2 0 8 1 9 7 0 3 2 5
AR89	AR11806	CS pack 12	8 4 1 2 0 8 1 2 1 7 0 1 7
AR79	Type A	PB pack 18	8 4 1 2 0 8 1 2 4 1 7 0 8

## ELECTRÓLISIS DE SAL SALT CHLORINATOR ELECTROLYSE AU SEL ELETTROLISI SALINA

Los cloradores por electrolisis de sal generan cloro para la desinfección de la piscina a partir de sal. La electrolisis de sal tiene varias ventajas: genera y dosifica automáticamente el cloro en la piscina, evita el almacenamiento y la manipulación de producto químico y es totalmente seguro, ya que sólo utiliza sal común.

Les chlorinateurs par électrolyse au sel génèrent du chlore pour la désinfection de la piscine grâce au sel. L'électrolyse au sel présente plusieurs avantages : Elle génère et dose automatiquement le niveau de chlore dans la piscine, évite le stockage et la manipulation de produits chimiques et est complètement sûre, étant donné qu'elle n'emploie que du sel commun.

Through electrolysis of salt, the chlorinators generate chlorine and salt to disinfect the swimming pool. The electrolysis of salt has various advantages: Generating and automatically dosing the chlorine in the swimming pool, avoids the handling and storage of chemical products and it completely safe, using only sodium chloride.

I clorinatori per elettrolisi salina producono cloro per la disinfezione della piscina partendo dal sale. L'elettrolisi salina ha diversi vantaggi: produce e provvede al dosaggio automatico del cloro nella piscina, evita l'immagazzinamento e l'uso di prodotti chimici ed è del tutto sicura in quanto fa uso del sale comune.

## PARA PISCINAS ELEVADAS Y ENTERRADAS FOR ABOVE GROUND AND IN GROUND POOLS POUR PISCINES ENTERRÉES ET HORS SOL PER PISCINE INTERRATE E FUORI TERRA

### GRE SALT SYSTEM

REF. SCG100 BXL PACK 1



Hasta 90m<sup>3</sup>  
Producción de cloro: 21 g/h  
Jusqu'à 90m<sup>3</sup>  
Production de chlore: 21 g/h

Until 90m<sup>3</sup>  
Chlorine production: 21 g/h  
Fino a 90m<sup>3</sup>  
Produzione di cloro: 21 g/h

REF. SCG60 BXL PACK 1



Hasta 60m<sup>3</sup>  
Producción de cloro: 12 g/h  
Jusqu'à 60m<sup>3</sup>  
Production de chlore: 12 g/h

Until 60m<sup>3</sup>  
Chlorine production: 12 g/h  
Fino a 60m<sup>3</sup>  
Produzione di cloro: 12 g/h



### GRE SALT SYSTEM + CPH14

REF. SCGPH100 BXL PACK 1



Electrolisis de sal + controlador de pH  
Hasta 90m<sup>3</sup>  
Producción de cloro: 21 g/h  
Electrolyse au sel contrôleur de pH  
Jusqu'à 90m<sup>3</sup>  
Production de chlore: 21 g/h

Salt chlorinator + pH-control  
Until 90m<sup>3</sup>  
Chlorine production: 21 g/h  
Elettrolisi salina + regolatore di pH  
Fino a 90m<sup>3</sup>  
Produzione di cloro: 21 g/h

REF. SCGPH60 BXL PACK 1



Electrolisis de sal + controlador de pH  
Hasta 60m<sup>3</sup>  
Producción de cloro: 12 g/h  
Electrolyse au sel contrôleur de pH  
Jusqu'à 60m<sup>3</sup>  
Production de chlore: 12 g/h

Salt chlorinator + pH-control  
Until 60m<sup>3</sup>  
Chlorine production: 12 g/h  
Elettrolisi salina + regolatore di pH  
Fino a 60m<sup>3</sup>  
Produzione di cloro: 12 g/h



### GRE BALANCE

REF. EESB55 CBX PACK 1



Hasta 55m<sup>3</sup>  
Producción de cloro: 8 g/h  
Fácil instalación, sin mantenimiento  
Jusqu'à 55m<sup>3</sup>  
Production de chlore: 8g/h  
Facile à installer, sans maintenance

Until 55m<sup>3</sup>  
Chlorine production: 8 g/h  
Easy installation, maintenance free  
Fino a 55m<sup>3</sup>  
Produzione di cloro: 8 g/h  
Semplice da installare, non necessita di manutenzione



**ANALIZADOR INTELIGENTE PARA LA PISCINA SMART POOL ANALYSER**  
**ANALYSEUR INTELLIGENT POUR LA PISCINE ANALIZZATORE INTELLIGENTE PER PISCINA**

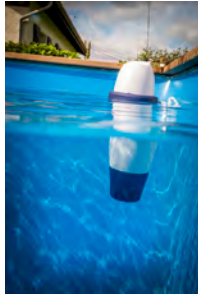

**blue connect**

REF. 70158-R CBX PACK 1



**Sensor innovador todo en uno**  
 Mide los principales parámetros de la piscina: Temperatura, pH, Nivel desinfectante (ORP), Conductividad (nivel de sales disueltas en agua)

**Capteur innovant tout en un**  
 Mesure les principaux paramètres de la piscine : température, pH, niveau désinfectant (ORP), conductivité (niveau de sels dissouts dans l'eau)

**Innovative all-in-one sensor**  
 Measure main parameters of pools: Temperature, pH, Disinfectant level (ORP), Conductivity (level of salts dissolved in water)

**Innovativo sensore tutto in uno**  
 Misura i principali parametri della piscina: Temperatura, pH, livello disinfettante (ORP), conduttività (livello di sali disciolti in acqua)



REF. 7015C001  
 BXL PACK 1



Batería para el Blue Connect. Bateria de litio de cloruro de tionilo.  
 Battery for the Blue Connect. Lithium thionyl chloride battery.  
 Batterie pour le Blue Connect. Batterie en lithium-chlorure de thionyle.  
 Batteria per il Blue Connect. Batteria al litio cloruro di tionile



REF. 7015R001  
 BXL PACK 1



Blue Sensor es un sensor compatible con Blue Connect con vida útil de 2 temporadas  
 Blue Sensor is compatible with Blue Connect with a useful life of 2 seasons  
 Blue Sensor est un capteur compatible avec le Blue Connect dont la durée de vie est de 2 saisons.  
 Blue Sensor è un sensore compatibile con Blue Connect con vita utile pari a 2 stagioni



REF. 7015C004  
 BXL PACK 1



Puente wifi bluetooth  
 Bluetooth WiFi bridge  
 Amplificateur Wi-Fi Bluetooth  
 Connessione wifi bluetooth



**Blue Check**  
 REF. 70971  
 BXL PACK 144



Tiras de prueba para analizar la calidad del agua de la piscina  
 After test to analyse water quality of the pool  
 Bandelettes d'analyse pour analyser la qualité de l'eau de la piscine.  
 Strisce di prova per analizzare l'acqua della piscina

## SAL ESPECIAL PARA PISCINA POOL SALT SEL SPÉCIAL PISCINE SALE PER PISCINE



REF. 90365

PB PACK 1



Sal compacta  
saco 25kg

Sel compacté  
sac 25kg

Compact salt  
bag 25kg

Sale compatto  
25kg

REF. AR2000

BXL PACK 1



Kit Bypass

Contiene: 3 Válvulas apertura/cierre + 2 mangueras Ø38 mm x 1,5 m + 6 piezas de reducción Ø38 - 50 mm para encolar + 4 abrazaderas

Kit Bypass

Comprend: 3 vannes ouverture / fermeture + 2 tuyaux Ø38 cm x 1,5 m + 6 pièces réduction Ø38 - 50 mm à coller + 4 colliers

Bypass kit

Contains: 3 opening/closing valves + 2 hoses Ø38 mm x 1,5 m + 6 reduction parts Ø38 - 50 mm to glue + 4 lamps

Kit Bypass

Contiene: 3 valvole di apertura/chiusura + 2 tubi flessibili Ø38 cm x 1,5 m + 6 pezzi adattatori Ø38 - 50 mm da incollare + 4 fascette

## BOMBA DOSIFICADORA Y CONTROLADOR POOL DOSING SYSTEMS CONTRÔLEUR ET DOSEUSE REGOLATORE E DOSATORE

REF. CPH14

BXL PACK 1



El controlador de pH con bomba peristáltica para piscina enterrada automatiza la regulación del pH, lo que permite estabilizar el pH en el valor ideal para su confort y optimizar la eficacia del tratamiento de desinfección.

Le contrôleur de pH avec pompe péristaltique pour piscine enterrée automatise la régulation du pH, ce qui permet de stabiliser le pH sur la valeur idéale pour votre confort et optimiser l'efficacité du traitement de désinfection.

pH-Control dosing system is a peristaltic pump designed to maintain a chosen pH level on inground pools, allowing stabilize the pH in the ideal value for comfort and to optimize the efficiency of the disinfection treatment.

Il regolatore di pH con pompa peristaltica per piscine interrata automatizza la regolazione del pH consentendo di stabilizzarlo su un valore ideale e ottimizzando l'efficacia del trattamento di disinfezione.

REF. BDP4

BXL PACK 1



Bomba dosificadora peristáltica. Caudal variable 4 l/h y 1,5 Bar. Permite dosificar el producto químico de forma fácil y segura.

Pompe doseuse péristaltique. Vitesse variable 4l/h et 1,5 bar. Permet le dosage de produit chimique de façon facile et précise.

Peristaltic dosing pump. Variable flow rate. 4 l/h and 1,5 Bar. Safe and easy way of dosing of the chemical product UV-C.

Pompa per il dosaggio del prodotto chimico. Pressione variabile 4 l/h e 1,5 Bar

## SEGURIDAD PISCINA Y ACCESORIO POOL SECURITY AND ACCESORY PROTECTION POUR PISCINE ET ACCESSOIRE PROTEZIONE PER PISCINE E ACCESSORIO



REF. 779700

CBX PACK 1



**Barrera de protección para piscinas.**  
Módulo premontado.  
Longitud adaptable.  
Adaptable a diferentes formas de piscina.  
Módulo de 3,66 m de uso individual.  
Altura de la barrera: 1,25 m.  
Tejido efecto transparente que permite una visibilidad excelente de la piscina.

**Safety fence for swimming pool.**  
Ready to install.  
Adjustable in length to answer all configurations.  
3,66m module for individual use.  
Fence height : 1,25m.  
Transparent net witch allows an excellent visibility of the swimming pool.

**Barrière de protection pour piscine.**  
Module pré-monté.  
Adaptable en longueur pour répondre à toutes les configurations.  
Module de 3,66m à usage individuel.  
Hauteur de la barrière : 1,25m.  
Toile effet «transparent» qui permet une excellente visibilité du bassin.

**Barriera di protezione per piscine.**  
Modulo pre installato.  
Lunghezza adattabile in base alle forme della piscina. Modulo di 3,66m ad uso individuale. Altezza della barriera:1,25 Tessuto effetto trasparente che permetta una visibilità eccellente della vasca.



REF. 770270

CBX PACK 1



**Alarma de piscina**  
Vigilancia máxima.  
Detector de inmersión certificado DE CONFORMIDAD con la norma NF P90 307/A1 por el LNE. Sin activación imprevista. Se coloca en modo vigilancia automática 15 minutos después del baño. Información permanente sobre el estado de la vigilancia.

**Pool alarm**  
Maximum surveillance.  
Immersion detector with CONFORMITY certificate with the NF P90 307/A1 Standard by LNE. Without unexpected activation. Automatically enters into surveillance mode 15 minutes after the last use of the pool. Permanent information about the surveillance status.



**Alarme de piscine**  
Surveillance maxi.  
Décteur d'immersion certifié CONFORME à la norme NF P90 307/A1 par le LNE. Aucun déclenchement intempestif. Remise en surveillance automatique 15 minutes après la baignade. Information permanente sur l'état de surveillance.

**Allarme per piscina**  
Massimo livello di vigilanza.  
Rilevatore di immersione certificato IN CONFORMITÀ con la normativa NF P90 307/A1 dell'LNE. Senza attivazione imprevista. Si posiziona in modalità di vigilanza automatica 15 minuti dopo l'utilizzo della piscina. Informazione permanente sullo stato di vigilanza.



### POOL ATHLETE

REF. PTR84

CBX PACK 1



Nueva manera revolucionaria de mantenerse en forma en la piscina. Diseño especial para piscinas sobre el suelo. También apto para piscinas enterradas.

New revolutionary way to keep fit in the pool.  
Special design for above ground pools.  
Also suitable for in-ground pools..

Nouvelle manière révolutionnaire de rester en forme dans la piscine.  
Design special pour piscines hors sol et enterrées.

Nuovo modo rivoluzionario per mantenersi in forma in piscina. Speciale design per piscine fuori terra. Adatto anche per piscine interrate

## ILUMINACIÓN PARA PISCINAS ENTERRADAS IN GROUND POOLS LIGHTING ÉCLAIRAGE POUR PISCINES ENTERRÉES ILLUMINAZIONE PER PISCINE INTERRATE

REF. PLCH144 BL PACK 1



Proyector 144 LEDs COLOR (RGB) piscina enterrada de HORMIGÓN.  
Projecteur de 144 LEDS de COULEUR pour piscine enterrée BÉTON.

Projector with 144 LEDs, colour RGB for CONCRETE pools.  
Faretto Ø 28 x 7, 144 LED MULTICOLOR RGB, per piscine interrate in MURATURA

REF. PLCL144 BL PACK 1



Proyector 144 LEDs COLOR (RGB) piscina enterrada de LINER.  
Projecteur de 144 LEDS de COULEUR pour piscine enterrée avec LINER.

Projector with 144 LEDs, colour RGB for LINER pools.  
Faretto Ø 28 x 7, 144 LED MULTICOLOR RGB, per piscine interrate con LINER.



REF. PLBH144 BL PACK 1



Proyector 144 LEDs blanco piscina enterrada de HORMIGÓN.  
Projecteur de 144 LEDS BLANCHES pour piscine enterrée BÉTON.

Projector with 144 white LEDs for CONCRETE pools  
Faretto Ø 28 x 7, 144 LED color BIANCO, per piscine interrate in MURATURA.

REF. PLBL144 BL PACK 1



Proyector 144 LEDs BLANCO piscina enterrada de LINER.  
Projecteur de 144 LEDS BLANCHES pour piscine enterrée LINER.

Projector with 144 WHITE LEDs for LINER in-ground pools.  
Faretto Ø 28 x 7, 144 LED color BIANCO, per piscine interrate con LINER.



## PISCINAS ENTERRADAS Y PISCINAS MADERA IN GROUND AND WODDEN POOLS POUR PISCINES ENTERRÉES ET BOIS PER PISCINE INTERRATE ED IN LEGNO

REF. PLREB BXL PACK 1



Proyector LED BLANCO para piscina enterrada y de madera  
Projecteur LED BLANCHE pour piscine enterrée et bois

WHITE LED projector for in-ground and wodden pools  
Faretto LED BIANCO per piscina interrata e in legno

REF. PLREC BXL PACK 1



Proyector LED COLOR para piscina enterrada y madera.  
Con control remoto  
Projecteur LED de COULEUR pour piscine enterrée et bois.  
Avec télécommande.

COLOR LED projector for in-ground and wooden pools.  
With remote control.  
Faretto LED MULTICOLOR per piscina interrata e in legno.  
Include telecomando.





REF. LLEDP56W

CBX PACK 1



Lámpara LED BLANCA PAR56 de muy fácil instalación 100% fabricada en EU (fábrica propia). Los LED ofrecen una vida útil de 100.000h y un flujo del 70% transcurridas 60.000h. Importantes ahorros en energía respecto a una lámpara halógena: hasta un 92%. 3 años de garantía.

Ampoule LED BLANCHE PAR56 très facile à installer 100% fabriquée dans la CEE (usine propre). Les ampoules offrent une durée de vie de 100 000 h et un flux de 70% après 60.000h. Importantes économies d'énergie par rapport à une ampoule halogène: jusqu'à 92%. 3 ans de garantie.

Easily installed PAR56 WHITE LED lamp 100% manufactured in EU (own production). LEDs has a useful life of 100,000 h and a 70% flow after 60,000 h. Important energy savings regarding a halogen lamp: up to 92%. 3 years guarantee.

Lampada PAR56 LED BIANCA PAR56 di semplicissima installazione, prodotta al 100% in EU (produzione propria). Offre una durata utile di 100.000 ore e un flusso del 70% dopo 60.000 ore. Ciò consente notevoli risparmi di energia rispetto a una lampada alogena: fino al 92% circa. 3 anni di garanzia.



REF. LLEDP56C

CBX PACK 1



Lámpara LED COLOR PAR56 de muy fácil instalación 100% fabricada en EU (fábrica propia). Los LED e ofrecen una vida útil de 100.000h y un flujo del 70% transcurridas 60.000h. Importantes ahorros en energía respecto a una lámpara halógena: hasta un 88%. 12 colores y 8 secuencias. 3 años de garantía.

Ampoule LED COULEUR PAR56 très facile à installer 100% fabriquée dans la CEE (usine propre). Les ampoules offrent une durée de vie de 100 000 h et un flux de 70% après 60 000 h. Importantes économies d'énergie par rapport à une ampoule halogène: jusqu'à 88%. 12 couleurs et 8 séquences. 3 ans de garantie.

Easily installed PAR56 COLOUR LED lamp 100% manufactured in EU (own production). LED has a useful life of 100,000 h and a 70% flow after 60,000 h. Important energy savings regarding a halogen lamp: up to 88% 12 colors and 8 sequences. 3 years guarantee.

Lampada LED COLOR PAR56 di semplicissima installazione, prodotta al 100% in EU (produzione propria). Offre una durata utile di 100.000 ore e un flusso del 70% dopo 60.000 ore. Ciò consente notevoli risparmi di energia rispetto a una lampada alogena: fino al 88% circa. 12 colori e 8 sequenze. 3 anni di garanzia.



REF. 40710

BX PACK 12



Bombilla 300w para proyector.  
Ampoule 300w pour projecteur.

300w bulb for underwater light.  
Lampada 300w per fero.

## ILUMINACIÓN PARA PISCINAS SOBRE SUELO ABOVE GROUND POOLS LIGHTING ÉCLAIRAGE POUR PISCINES HORS SOL ILLUMINAZIONE PER PISCINE FUORI TERRA

REF. PLWPB

CBX PACK 4



### Proyector led blanco para piscinas de madera y composite

Led de bajo consumo. Potencia 16w. Fácil instalación. Ofrecen una vida útil entre 50.000 y 100.000 horas. Gran calidad: Fabricado en Europa. Incluye 5m de cable + transformador.

Projecteur led blanc pour piscines en bois et composite. Led à basse consommation. Puissance 16w. Facile à installer. Durée de vie : de 50 000 à 100 000 heures. Grande qualité : Fabriqué en Europe. Comprend: 5m câble + transformateur.

### White LED projector for wooden and composite pools.

Low consumption LED. Power: 16 W. Easy installation, since a standard plug is included Long life: 50.000 to 100.000 hours. High quality: Made in Europe. 5m wire + transformer included.

Proiettore a led di colore bianco per piscine in legno e in materiale composito. Led a basso consumo Potenza 16w. Semplice da installare. Offrono una vita utile compresa tra 50.000 e 100.000 ore. Qualità elevata: Prodotto in Europa. 5m cavo + trasformador.



REF. LEDRW

CBX PACK 12



Proyector LED BLANCO de alto rendimiento para conectar a la válvula de retorno. Adaptable a piscinas elevadas tanto autoportantes como de pared rígida. Caudal mínimo necesario: 3.000 l/h. Funciona sin necesidad de batería.

Projecteur LED BLANCHE à haut rendement pour connecter à la buse de refoulement. Adaptable à des piscines hors-sol, aussi bien autoportantes qu'avec des parois rigides. Débit minimum nécessaire : 3 000 l/h. Fonctionne sans nécessité de batterie.

WHITE LED projector for connecting to the return valve. Adaptable for movable above ground pools with rigid walls. High performance WHITE LEDs. Generates light at no cost, does not need batteries. Minimal flow needed: 3000 l/h

Proiettore LED BIANCO a resa elevata per connessione alla valvola di ritorno. Si adatta a piscine fuori terra, sia autoportanti che a parete rigida. Flusso minimo necessario: 3.000 l/h. Funziona senza batteria.



REF. LEDRC

CBX PACK 12



Proyector LED COLOR de alto rendimiento para conectar a la válvula de retorno. Adaptable a piscinas elevadas tanto autoportantes como de pared rígida. Caudal mínimo necesario: 3.000 l/h. Funciona sin necesidad de batería.

Projecteur LED COULEUR à haut rendement pour connecter à la buse de refoulement. Adaptable à des piscines hors-sol, aussi bien autoportantes qu'avec des parois rigides. Débit minimum nécessaire : 3 000 l/h. Fonctionne sans nécessité de batterie.

COLOUR LED projector for connecting to the return valve. Adaptable for movable above ground pools with rigid walls. High performance COLOUR LEDs. Generates light at no cost, does not need batteries. Minimal flow needed: 3000 l/h

Proiettore LED COLOR a resa elevata per connessione alla valvola di ritorno. Si adatta a piscine fuori terra, sia autoportanti che a parete rigida. Flusso minimo necessario: 3.000 l/h. Funziona senza batteria.







Ref. PLPB14

CBX PACK 1



Proyector LED BLANCO para conectar a la válvula de retorno. Hasta un 90% de ahorro de energía. Vida útil de 50,000h. 1.600 lumens.

Projecteur LED BLANCHE pour connecter à la buse de refoulement. Jusqu'à 90% d'économie d'énergie. Durata utile di 50,000. 1.600 lumens.

WHITE LED projector to connect to the return valve. Up to 90% energy saving. Useful life of 50,000h. 1.600 lumens.

Proiettore LED BIANCO per connessione alla valvola di ritorno. Fino al 90% di risparmio di energia. Durata utile di 50.000 ore. 1.600 lumens.



REF. PLED1C

BL PACK 12



Proyector LED COLOR para piscina elevada de acero. Fácil instalación, se pega a la chapa mediante un imán. Incorpora mando a distancia para fácil manejo. Tecnología Led de bajo consumo.

Projecteur LED de COULEUR pour piscine hors sol. Ils sont spécialement conseillés pour les piscines hors sol en tôle. Se fixe simplement sur la tôle grâce à un aimant. Ils incorporent une télécommande très simple à utiliser. Technologie LED à faible consommation.

COLOR LED projector for above ground pools. Stick to the sheet with a magnet and ready to use. Includes remote control for easy operation. Energy-saving LED technology.

Faretto LED MULTICOLOR per piscina fuoriterra. Foglio adesivo con un magnete pronto all'uso. Include telecomando a distanza per un facile funzionamento. Risparmio energetico tecnologia al LED.



REF. PLED2

CS PACK 4



Conjunto de 2 proyectores LED BLANCOS para piscina elevada de acero. Fácil instalación, se pega a la chapa mediante un imán. Incorpora mando a distancia para fácil manejo. Tecnología Led de bajo consumo.

Ensemble de 2 projecteurs LED pour piscine hors sol. Ils est spécialement conseillé pour les piscines hors sol en tôle. Se fixe simplement sur la tôle grâce à un aimant. Il incorpore une télécommande très simple à utiliser. Technologie LED à faible consommation.

Set of 2 WHITE LED projectors for above ground pools. Stick to the sheet with a magnet and ready to use. Includes remote control for easy operation. Energy-saving LED technology.

2 Faretto LED per piscina fuoriterra. Foglio adesivo con un magnete pronto all'uso. Include telecomando a distanza per un facile funzionamento. Risparmio energetico tecnologia al LED.

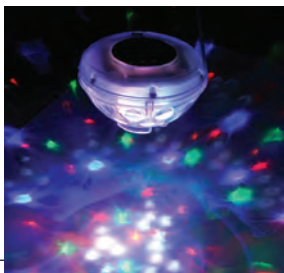

REF. 90173

CBX PACK 12



**Lámpara fantasía**  
7 programas de luz diferentes.

**Lampe fantasie**  
sept jeux de lumière sur les parois et le fond de la piscine.

**Fancy lamp**  
7 different lighting programmes.

**Lampada fantasia**  
sette giochi di luce differenti ai lati della piscina e sul fondo.

## CALEFACCIÓN HEATING SYSTEMS CHAUFFAGE RISCALDAMENTO

La bomba de calor es el método más eficiente para calentar una piscina y además permite alargar la temporada de baño. Las bombas de calor mueven la energía térmica en la dirección opuesta a la transferencia de calor espontánea, al absorber el calor de un espacio frío y liberarlo a uno más cálido.

The heat pump is the most efficient method for heating a pool and in addition allows extending the bathing season. Heat pumps move thermal energy in the opposite direction to spontaneous heat transfer, by absorbing heat from a cold space and releasing it into a hotter one.

La pompe à chaleur est la méthode la plus efficace pour chauffer une piscine, et permet en outre d'allonger la saison des baignades. Les pompes à chaleur déplacent l'énergie thermique dans le sens opposé au transfert de chaleur spontanée, en absorbant la chaleur d'un espace froid et en la libérant dans un espace plus chaud.

La pompa di calore rappresenta il metodo più efficace per riscaldare la piscina e consente di utilizzarla tutto l'anno. Le pompe di calore muovono l'energia termica in direzione opposta rispetto al trasferimento spontaneo di calore, assorbendo calore da uno spazio freddo e rilasciandolo in uno più caldo.

## BOMBAS DE CALOR MINI PARA PISCINAS SOBRE SUELO ABOVE GROUND POOLS MINI HEAT PUMPS POMPES DE CHALEUR MINI POUR PISCINES HORS SOL POMPA DI CALORE MINI PER PISCINE FUORI TERRA

### MINI HEAT PUMPS

REF. HPM30 BXL PACK 1



Bomba de calor Mini para pequeño volumen de agua: hasta 30m<sup>3</sup>. No necesita bypass. Conexiones 32 y 38 mm.

Mini heat pumps for reduced water volumes: up to 30 m<sup>3</sup>. Bypass not necessary. 32 and 38 mm connections.

Pompe à chaleur Mini pour petit volume d'eau : jusqu'à 30m<sup>3</sup>. Il n'a pas besoin de bypass. Embouts soudés 32 et 38 mm.

Pompa di calore Mini per piscine a ridotto volume di acqua: fino a 30m<sup>3</sup>. Non ha bisogno di un bypass. Raccordi 32 e 38 mm.

REF. HPM20 BXL PACK 1



Bomba de calor Mini para pequeño volumen de agua: hasta 20m<sup>3</sup>. No necesita bypass. Conexiones 32 y 38 mm.

Mini heat pumps for reduced water volumes: up to 20 m<sup>3</sup>. Bypass not necessary. 32 and 38 mm connections.

Pompe à chaleur Mini pour petit volume d'eau : jusqu'à 20 m<sup>3</sup>. Il n'a pas besoin de bypass. Embouts soudés 32 et 38 mm.

Pompa di calore Mini per piscine a ridotto volume di acqua: fino a 20m<sup>3</sup>. Non ha bisogno di un bypass. Raccordi 32 e 38 mm.



#### Configurador de bombas de calor

Encuentra la bomba de calor ideal para tu piscina.

#### Heat pump configuration

Find the ideal heat pump for your pool.

#### Configurateur de pompes à chaleur

Trouver le modèle le plus adapté à votre piscine

#### Configuratore di pompa di calore

Trova la pompa di calore ideale per la tua piscina



Más información sobre las bombas mini en el siguiente video.

More information about heat pumps in the following video.

Plus d'informations sur les pompes Mini dans la vidéo suivante.

Maggiori informazioni sulle pompe di calore sono disponibili nel video riportato a continuazione.

**BOMBAS DE CALOR GRE**  
**GRE HEAT PUMPS**  
**POMPES DE CHALEUR GRE**  
**POMPA DI CALORE GRE**



Volumen max. Volume max	Max. volume Volume massimo	15 m <sup>3</sup>	30 m <sup>3</sup>	60 m <sup>3</sup>	80 m <sup>3</sup>	120 m <sup>3</sup>
Referencia Référence	Reference Codice articolo	<b>777590</b>	<b>777591</b>	<b>778375</b>	<b>778392</b>	<b>778393</b>
Temperatura min/max Plage fonctionnement	Min/max temperature Temperature min.max	- 5 + 43 °C	- 5 + 43 °C	- 5 + 43 °C	- 5 + 43 °C	- 5 + 43 °C
Potencia calorífica Puissance de chauffage	Heating power Potenza di riscaldamento	3,5 Kw	5 Kw	8,7 Kw	12 Kw	24 Kw
COP COP	COP COP	5,8 W/W	5,6 W/W	6,0 W/W	6,0 W/W	6,0 W/W
Potencia enfriamiento Puissance refroidissement	Coolness power Potenza di raffreddamento	2,4 kW	3,3 kW	6,0 kW	8,0 kW	15,0 kW
Potencia de absorción Puissance absorbée	Absorption power Potenza assorbimento	0,6 kW	0,9 kW	1,45 kW	2 kW	2,6 kW

Compresor de rotación Hitachi. Rotation compressor of Hitachi.  
 Compresseur à rotation Hitachi. Compresore di rotazione Hitachi

Carga Charge	Charge Peso	800 g	800 g	1100 g	1200 g	2500 g
Alimentación eléctrica monofásica Alimentation électrique monophasée	Electrical source power single-phase Alimentazione elettrica monofase	220-240/50 V/Hz				
Conexión eléctrica Raccordement électrique	Electrical connection connessione elettrica	Toma tierra earth ground Avec terre messa a terra	Diferencial (no incluido) Dfferential (not included) Boite de dérivation (non fournie) differenziale(non incluso)			
Resistencia titanio Résistance en titane	Titanium resistance Resistenza in titanio	Titanio Titanium Titane Titanio				
Flujo de salida mínimo Débit minimum à la sortie	Minimal flow of exit Flusso minimo in uscita	2,5m <sup>3</sup> /h	2,8m <sup>3</sup> /h	5,2m <sup>3</sup> /h	6,9m <sup>3</sup> /h	12m <sup>3</sup> /h
Conex Raccords	Conexión Connessione	50 mm				
Nivel de ruido del 1 al 10 Niveau sonore de 1 à 10 m	Sound level from 10m to 1m Livello sonoro da 1 a 10	35/42 dB(A)	35/44 dB(A)	36/45 dB(A)	36/45 dB(A)	47/56 dB(A)

Visualización de los parámetros de funcionamiento por pantalla LED. Display of operating parameters through LED screen.  
 Affichage des paramètres de fonctionnement par écran LED. Visualizzazione dei parametri di funzionamento mediante LED

Medida producto Dimensions l'appareil	Product size Misura prodotto	750 x 500 x 290 mm	750 x 500 x 325 mm	930 x 550 x 360 mm	1000 x 620 x 360 mm	1045 x 855 x 410 mm
Medida con caja Dimensions du carton	Packaging size Misura imballaggio	850 x 530 x 330 mm	855 x 530 x 330 mm	1060 x 600 x 380 mm	1065 x 670 x 380 mm	1140 x 955 x 430 mm
Peso net/bru Poids net/brut	Net/brut weight Peso net/brut	32/37 kg	37/42 kg	50/56 kg	65/72 kg	110/117 kg

Código EAN  
Gencod

EAN Code  
Codice a barrie



**CALEFACCIÓN SOLAR SOLAR HEATING SYSTEM  
CHAUFFAGE SOLAIRE RISCALDAMENTO SOLARE**

Sistemas para calentamiento del agua de la piscina mediante la acción solar. Solar pool water heating systems.  
Chauffage solaire pour piscine. Fabriqué en polyéthylène. Sistema per il riscaldamento dell'acqua della piscina per mezzo dell'azione del sole.



REF. AR2069 CBX PACK 1



Fabricado en polietileno. Aumenta la Temperatura del agua hasta 6°C. Mas de 12 kw/h de calor al dia. 600x60 cm. Peso 7 kg. Potencia de la bomba mínima recomendada: 1/3 CV.

Made of polythene. Water temperature can be increased up to 6 °C. 600x60 cm. Wight: 7 kg. Minimum recommended pump output: 1/3 hp.

Il augmente la température de l'eau jusqu'à 6°C. 600x60 cm. Poids 7 kg. Puissance de la pompe minimale recommandée: 1/3 CV.

In polietilene. Aumenta la temperatura dell'acqua fino a 6°C. 600x60 cm. Peso 7 kg. Potenza minima della pompa raccomandata: 1/3 CV.



REF. AR20693 CBX PACK 1



Calentador solar de agua para piscinas autoportantes. Fabricado con materiales flexibles (nylon y pvc). Medidas: 130x80 cm. Peso 1,2 kg. Aumenta la Temperatura del agua hasta 4°C. Funciona con bomba de piscina desde 2m³/h.

Solar pool water heating system for inflatable pools. Made of flexible materials (nylon and pvc). Dimensions: 130x80 cm. Weight: 1,2 kg. Water temperature can be increased up to 4°C. Minimum water volume: 2m³/h.

Rechauffeur solaire pour piscines autoportantes. Fabriqué avec des matériaux souples (nylon et pvc). Dimensions: 130x80cm. Poids 1,2 kg. Augmente la température de l'eau jusqu'a 4°C. Puissance de la pompe minimum recommandée: 2m³/h.

Sistema di riscaldamento solare di acqua per piscine autoportanti. Fabricato con materiali flessibili (nylon e pvc). Misure: 130x80 cm. Peso 1,2 kg. Aumenta la temperatura dell'acqua fino a 4°C. Funziona con pompe da piscina da 2m³/h.



REF. 90230 CBX PACK 1



Permite aumentar la temperatura de su piscina por la acción del sol. Los calentadores pueden conectarse entre sí en serie. Aumenta la temperatura del agua 3°C en piscinas entre 7,5m³ y 10m³.

Solar pool water heating system. The heaters should be connected in series to heat the pool. Each solar heater increases the temperature of the swimming pool by 3°C due to solar action.

Système pour le chauffage solaire de l'eau de la piscine. Les réchauffeurs peuvent se connecter entre eux en série. Augmente la température de 3°C max. pour les piscines entre 7,5m³ et 10m³.

Permette di aumentare la temperatura della sua piscina tramite l'azione dei raggi solari. Ogni riscaldatore solare permette di aumentare la temperatura della piscina no a 3°C tramite l'azione naturale del sole.

**DUCHAS MINIMAL MINIMAL SHOWERS**  
**DOUCHES MINIMAL DOCCIA MINIMAL**



**REF. DAI43F**  
**BXL PACK 1**



Ducha de acero inoxidable.  
 Tubo Ø43 mm.  
 Rociador antical.  
 Incluye lavapiés.

Stainless steel shower.  
 43 mm diameter tube.  
 Lime-free overhead sprayer.  
 Includes foot tap.

Douche en acier inoxydable.  
 Tube Ø43 mm.  
 Pomme anti-calcaire.  
 Inclut un rince-pieds.

Doccia in acciaio inossidabile.  
 Tubo Ø43 mm.  
 Doccino anticalcare.  
 Include lavapiedi.



**REF. DAI43**  
**BXL PACK 1**



Ducha de acero inoxidable.  
 Tubo Ø43 mm.  
 Rociador antical.

Stainless steel shower.  
 43 mm diameter tube.  
 Lime-free overhead sprayer.

Douche en acier inoxydable.  
 Tube Ø43 mm.  
 Pomme anti-calcaire.

Doccia in acciaio inossidabile.  
 Tubo Ø43 mm.  
 Doccino anticalcare.

**DUCHAS SOLARES SOLAR SHOWERS**  
**DOUCHES SOLAIRES DOCCIA SOLARI**



**REF. DSALR32W**  
**BXL PACK 1**



Ducha solar redonda 32l  
Aluminio aspecto madera  
Con grifo lavapies

Round solar shower 32l  
Aluminium Woodlike  
With footwash tap

Douche solaire ronde 32l  
Aluminium Aspect bois  
Avec robinet lave pieds

Doccia solare round 32l  
Alluminio Imitazione legno  
Rubinetto lavapiedi



**REF. DSALC32W**  
**BXL PACK 1**



Ducha solar cuadrada 32l  
Aluminio Aspecto madera  
Con grifo lavapies

Square solar shower 32l  
Aluminium Woodlike  
With footwash tap

Douche solaire carrée 32l  
Aluminium Aspect bois  
Avec robinet lave pieds

Doccia solare square 32l  
Alluminio Imitazione legno  
Rubinetto lavapiedi

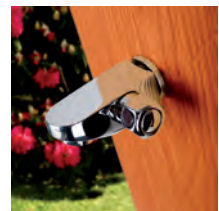
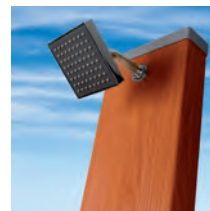

**Ref. DSPS35**  
**BXL PACK 1**



Ducha solar 35l  
PVC-Con grifo lavapies

Solar shower 35l  
PVC. With footwash tap

Douche solaire 35l  
PVC. Avec robinet  
lave pieds

Doccia solare 35l  
PVC. Rubinetto lavapiedi



**REF. AR1130**  
**BXL PACK 1**



Ducha solar de jardín 32l  
Aluminio  
Con nebulizador y grifo  
lavapies

Round solar shower 32l  
Aluminium  
With footwash tap

Douche solaire 32 litres  
avec brumisateur et  
lave-pieds  
Aluminium

Doccia solare 32l  
Alluminio  
Nebulizzatore e rubinetto  
lavapiedi





Ref. AR1035W  
BXL PACK 1



Ducha solar 35l  
PVC aspecto madera  
Douche solaire 35l  
PVC Aspect bois

Solar shower 35l  
Woodlike PVC  
Doccia solare 35l  
PVC Imitazione legno



REF. AR1035  
BXL PACK 1



Ducha solar 38l - PVC  
Douche solaire de jardin  
38l - PVC

Garden solar shower  
38l - PVC  
Doccia solare 38l - PVC



REF. AR1030  
BXL PACK 1



Ducha solar 30l  
PVC  
Douche solaire de  
jardin 30l - PVC

Garden solar  
shower 30l - PVC  
Doccia solare 30l - PVC



REF. AR10250  
BXL PACK 1



Ducha solar 25l  
PVC  
Douche solaire de  
jardin 25l - PVC

Garden solar  
shower 25l - PVC  
Doccia solare 25l - PVC

# complementos complements



**REF. AR1020W**  
**BXL PACK 1**



Ducha solar 20l  
PVC aspecto madera  
Douche solaire 20l  
PVC Aspect bois

Solar shower 20l  
Woodlike PVC  
Doccia solare 20l  
PVC Imitazione legno



**REF. 40664A**  
**BXL PACK 1**



Ducha solar 20l  
PVC  
Douche solaire de  
jardin 20l - PVC

Garden solar  
shower 20l - PVC  
Doccia solare 20l - PVC



**REF. AR1020P**  
**BXL PACK 1**



Ducha solar 20l - PVC  
Douche solaire de jardin  
20l - PVC

Garden solar shower  
20l - PVC  
Doccia solare 20l - PVC



**REF. AR1009**  
**BXL PACK 1**



Ducha solar 9l - PVC  
Douche solaire de jardin  
9l - PVC

Garden solar shower  
9l - PVC  
Doccia solare 9l - PVC







REF. AR104

CBX PACK 6



8 4 1 2 0 8 1 9 5 0 7 1 6

Ducha aluminio. Fácil instalación y conexión

Aluminium shower. Easy installation and connection

Douche en aluminium. Montage et raccordement facile

Doccia alluminio. Facilità di installazione e collegamento



REF. DPE10

CBX PACK 12



8 4 1 2 0 8 1 2 5 7 5 0 1

Ducha para piscina sobre suelo. Con sistema de fijación al pasamanos de la escalera

Above-ground pool shower. With stair railings fixing system. No tools required

Douche pour piscine hors sol. Système de fixation à mâchoire universelle pour échelle tubulaire ou autres supports

Doccia per piscine fuori terra. Con sistema di fissaggio al corrimano della scaletta



REF. LP01

PB PACK 12



8 4 1 2 0 8 1 2 3 7 6 9 5

Lavapiés

Footwash

Pédiluve

Lavapièdi

## RACORDERÍA PVC FITTINGS RACCORDS PVC RACCORDERIA IN PVC



**REF. 40537**  
**BX PACK 15**



Enlace Ø 50 HXH PN16  
PVC screw Ø 50 mm PN16  
Raccord PVC Ø 50 HXH PN16  
Raccordo Ø 50 HXH PN16



**REF. 40538**  
**BX PACK 20**



Enlace 3P. Ø 50 macho 1" 1/2 PN16  
PVC 3 piece union solvent socket  
Ø50mm1"1/2  
Raccord PVC en 3 parties Ø50 macho 1" 1/2  
PN16  
Raccordo 3P. Ø 50 maschio 1" 1/2 PN16



**REF. 40539**  
**BX PACK 15**



Raccordo 3P. Ø 50 macho 2" PN16  
PVC 3 piece union solvent socket  
Ø50mm 2"  
Raccord PVC en 3 parties Ø 50 macho  
2" PN16  
Raccordo 3P. Ø 50 maschio 2" PN16



**REF. 40541**  
**BX PACK 8**



Válvula antiretorno Ø 50 PN16  
Check valve Ø 50 mm  
Valve anti-retour Ø 50 PN16  
Valvola ritorno Ø 50 PN16



**REF. 40543**  
**BX PACK 6**



Válvula Ø 50 PN10 PN10  
PVC ball valve Ø 50 mm PN10  
Valve anti-retour Ø 50 PN10  
Valvola Ø 50 PN10 PN10



**REF. 40555**  
**BX PACK 10**



Racord curva Ø 50 90° PN16  
PVC elbow fitting 90° Ø 50 mm PN16  
Valve anti-retour 90° Ø 50 PN16  
Valvola 90° Ø 50 PN16



**REF. 40590**  
**BX PACK 30**



Codo Ø 50 90° PN16 - para encolar  
PVC 90° elbow solvent socket Ø 50 mm  
Coude PVC à coller Ø 50 90° PN16  
Gomito Ø 50 90° PN16 - da incollare



**REF. 40591**  
**BX PACK 40**



Codo Ø 50 45° PN16  
PVC 45° elbow solvent socket Ø 50 mm  
Coude PVC Ø 50 45° PN16  
Gomito Ø 50 45° PN16



**REF. 40592**  
**BX PACK 24** 8 427370 405921

Te Ø 50 PN16 - para encolar  
PVC-Tee 90° solvent socket Ø 50 mm  
Raccord en T à coller Ø 50 PN16  
Raccordo a T Ø 50 PN16 - da incollare



**REF. 40593**  
**BX PACK 60** 8 427370 405938

Racord Ø 50 PN16 - para encolar  
PVC union solvent socket Ø 50 mm  
Raccord PVC à coller Ø 50 PN16  
Raccordo Ø 50 PN16 - da incollare



**REF. 40646**  
**BX PACK 8** 8 427370 406461

Válvula Ø50 PN10, manguito rosca macho  
Ball valve Ø50 mm  
Vanne Ø50 PN10 embout mal  
Valvola Ø50 PN10, tubo filettato maschio



**REF. 40553**  
**BX PACK 12** 8 427370 405532

Adhesivo para PVC 250 g  
Blue Adhesive for flexible PVC pipes 250 g  
Colle PVC 250gr  
Adesivo per PVC 250 g



**REF. 787104** **BX PACK 1** 3 605217 871046

Manguera semirígida reforzada, transparente, Ø38mm. 25m  
Tuyau semi-rigide reforcé, Transparent, Ø38mm. 25m  
Semi-rigid reinforced hose, transparent, Ø38mm. 25m  
Tubo semirigido inforzato, trasparente, Ø38mm. 25m



**REF. 40557** **PB PACK 1** 8 427370 405570

Tubo PVC semirígido Ø 50, 25m  
Couronne PVC semi-rigide Ø 50, 25m  
Semi-rigid PVC hose Ø 50 mm, 25m  
Tubo PVC semirigido Ø 50, 25m



## Leyenda Legend Légende Legenda

### **BX**

caja  
box  
box  
scatola

### **BXL**

caja con etiqueta  
box and label  
carton avec étiquette  
scatola con etichetta

### **CB**

cartoncillo  
cardboard wrap  
bande carton  
cartone

### **CBX**

caja litografiada  
colour box  
boîte de couleur  
scatola serigrafata

### **PB**

bolsa de plástico  
polybag  
sac plastique  
busta di plastica

### **PBH**

bolsa de plástico con cartoncillo  
polybag with header  
sac plastique avec bande carton  
sacchetto di plastica con cartone

### **BL**

blistér  
blister  
blister  
blister

### **CS**

doble burbuja  
clamshell  
double coque  
doppio rivestimento

### **DIS**

display  
display  
display  
display



manguera  
hose  
tuyau  
tubo



cable  
wire  
câble  
cavo

# material de cleaning limpieza material

MATERIAL DE LIMPIEZA	130	CLEANING MATERIAL
Robots	132	Robots
Limpiafondos eléctricos	136	Electric cleaners
Limpiafondos automáticos	138	Automatic cleaners
Limpiafondos de aspiración	141	Vacuum cleaners
Kits limpiafondos	142	Vacuum cleaners kits
Limpiafondos Ventury	143	Ventury vaccum
Gama Graphite	144	Graphite range
Gama Confort	146	Confort range
Limpiafondos manuales	148	Vacuum heads
Recogehojas	148	Leaf nets and rakes
Cepillos	149	Brushes
Termómetros	150	Thermometers
Mangos telescópicos	151	Telescopic handles
Dosificadores	152	Dispensers
Cardboard range	154	Cardboard range
Gama ECO	157	ECO range
Espojas	160	Sponges
Protección invierno	161	Winter protection
Mangueras flotantes	162	Vacuum hoses

# matériel de nettoyage materiale di pulizia

MATÉRIEL DE NETTOYAGE	130	MATERIALE DI PULIZIA
Robots	132	Robots
Nettoyeurs de fond électriques	136	Pulitore elettrico
Nettoyeurs automatiques	138	Puliscifondi automatici
Nettoyeurs pour aspiration	141	Pulitore fondo ad aspirazione
Kit nettoyeurs	142	Kit Pulitore fondo
Aspirateurs de fond ventury	143	Puliscifondi Ventury
Gamme Graphite	144	Gamma Graphite
Gamme Confort	146	Gamma Confort
Balais manuels	148	Puliscifondo manuale
Épuisettes	148	Raccoglitori
Brosses	149	Spazzole
Thermomètres	150	Termometri
Manches télescopiques	151	Manico telescopico
Doseurs	152	Dosatori
Cardboard range	154	Cardboard range
ECO	157	ECO
Eponges	160	Spugne
Protection hiver	161	Protezione inverno
Tuyaux flottants	162	Tubi galleggianti

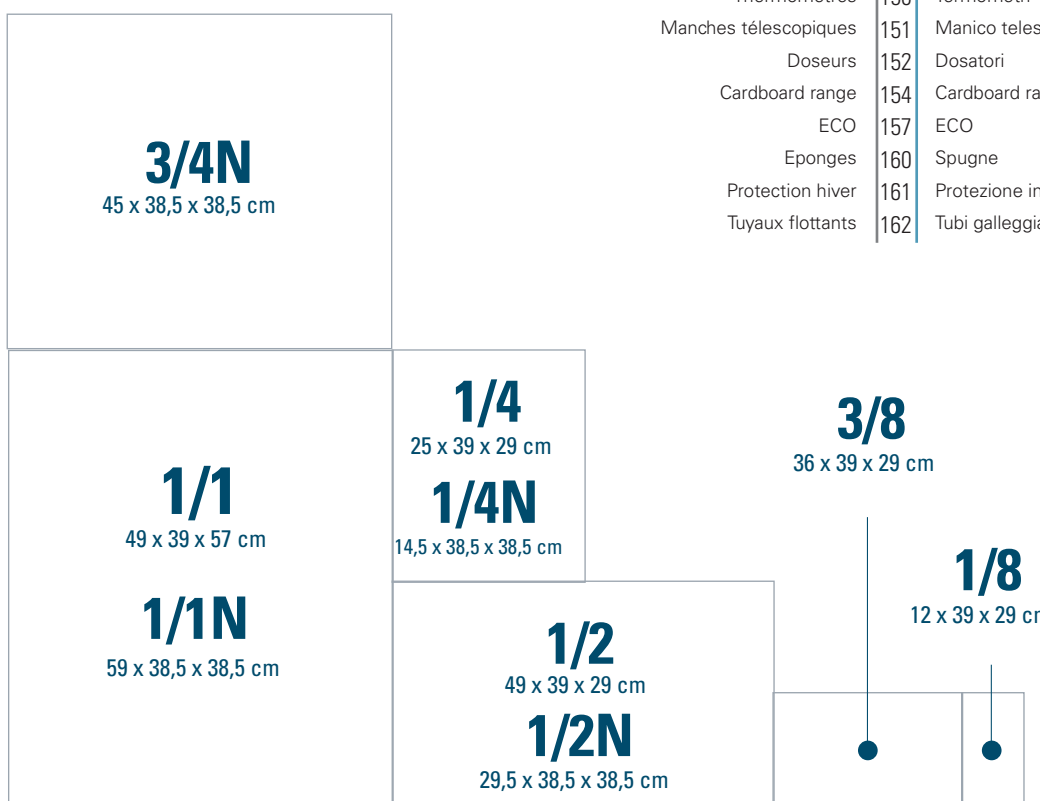

# material de limpieza

# cleaning material

## ROBOTS LIMPIAFONDOS PISCINAS POOL ROBOTS ROBOTS PISCINE ROBOTS PER PISCINA



### KAYAK FUTURE REMOTE CONTROL

REF. RKFA100CR



18 m

CBX PACK 1



8 412081 253312

El Kayak Future CR se adapta a todo tipo de piscinas hasta 120m<sup>2</sup> de superficie y limpia el fondo, las paredes y la línea de agua de su piscina.

Le robot Kayak Future RC convient pour tout type de piscine d'une superficie jusqu'à 120 m<sup>2</sup>. Il nettoie le fond, les parois ainsi que la ligne d'eau.

The Kayak Future CR adapts to all types of pools measuring up to 120m<sup>2</sup> in surface area, cleaning the bottom, walls and water line.

Il Robot Kayak Future CR si adatta a tutti i tipi di piscine fino a 120m<sup>2</sup> di superficie, pulendo il fondo, le pareti e linea dell'acqua.

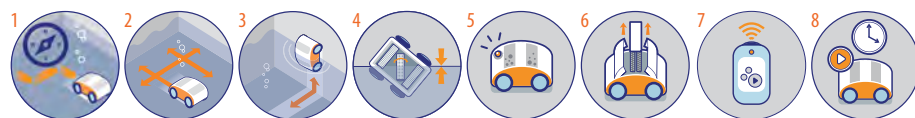

### KAYAK FUTURE

REF. RKFA100



18 m

CBX PACK 1



8 412081 250847

El Kayak Future se adapta a todo tipo de piscinas hasta 120m<sup>2</sup> de superficie y limpia el fondo, las paredes y la línea de agua de su piscina.

Le robot Kayak Future convient pour tout type de piscine d'une superficie jusqu'à 120 m<sup>2</sup>. Il nettoie le fond, les parois ainsi que la ligne d'eau.

The Kayak Future adapts to all types of pools measuring up to 120m<sup>2</sup> in surface area, cleaning the bottom, walls and water line.

Il Robot Kayak Future si adatta a tutti i tipi di piscine fino a 120m<sup>2</sup> di superficie, pulendo il fondo, le pareti e linea dell'acqua.

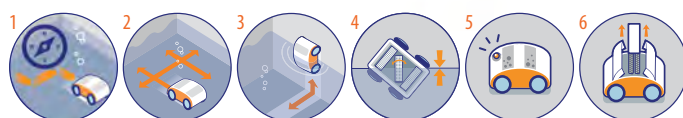

- 1. GYRO:** Nuevo Sistema de Navegación Giroscópica que maximiza el ciclo de lavado y evita que el cable se enrede **New Gyroscopic Navigation System to improve navigation of the robot, maximize efficacy and prevent cable tangling** Nouveau système de navigation qui maximise le cycle de lavage et empêche câble enchevêtrement **Novo sistema di navigazione che massimizza il ciclo di lavaggio e previene l'aggrovigliamento del cavi**
- 2. Aquasmart System:** Algoritmo patentado para limpiar la piscina en menos tiempo **Patented algorithm for covering a pool with less time** La fonction Aquasmart est un algorithme permettant un nettoyage plus rapide et plus efficace **Algoritmo certificato per pulire una piscina in minor tempo**
- 3. Floor & Walls:** Limpia el suelo y las paredes de la piscina **Cleans the bottom and walls** Nettoie le fond et les parois de la piscine **Pulisce fondo e pareti della piscina**
- 4. Water line:** Limpia la línea de flotación **Cleans the water line** Nettoyage de la ligne d'eau **Pulisce la linea dell'acqua**
- 5. Filter check:** Indicador de filtro lleno mediante LED **Full filter LED indicator** Indicateur LED dans le transformateur indiquant que le filtre est plein **Indicatore filtro pieno mediante un LED luminoso**
- 6. Top access:** Filtro de acceso superior **Top access filter** Filtre facile à nettoyer avec le système top access **Accesso al filtro nella parte superiore del robot**
- 7. Remote Control:** Con mando a distancia **With easy remote control** Télécommande de contrôle **Telecomando a distanza**
- 8. Timer:** Ciclo de limpieza programable **Programmable cleaning cycle** Cycle de nettoyage programmable **Ciclo di pulizia programmabile**

# matériel de nettoyage materiale di pulizia



## TRACK 4x4

REF. R44SP

18 m

CBX PACK 1



El Track 4x4 se adapta a todo tipo de piscinas hasta 90m<sup>2</sup> de superficie y limpia el fondo, las paredes y la línea de agua de su piscina.

Le robot Track 4x4 convient pour tout type de piscine d'une superficie jusqu'à 90 m<sup>2</sup>. Il nettoie le fond, les parois ainsi que la ligne d'eau.

The Track 4x4 adapts to all types of pools measuring up to 90m<sup>2</sup> in surface area, cleaning the bottom, walls and water line.

Il Robot Tracks 4x4 si adatta a tutti i tipi di piscine fino a 90m<sup>2</sup> di superficie, pulendo il fondo, le pareti e linea dell'acqua.



## KAYAK ADVENTURE

REF. RKA80

18 m

CBX PACK 1



El Kayak Adventure se adapta a todo tipo de piscinas hasta 100m<sup>2</sup> de superficie y limpia el fondo, las paredes y la línea de agua de su piscina.

Le robot Kayak Adventure convient pour tout type de piscine d'une superficie jusqu'à 100m<sup>2</sup>. Il nettoie le fond, les parois ainsi que la ligne d'eau.

The Kayak Adventure adapts to all types of pools measuring up to 100m<sup>2</sup> in surface area, cleaning the bottom, walls and water line.

Il Robot Kayak Adventure si adatta a tutti i tipi di piscine fino a 100m<sup>2</sup> di superficie, pulendo il fondo, le pareti e linea dell'acqua.



1. **GYRO:** Nuevo Sistema de Navegación Giroscópica que maximiza el ciclo de lavado y evita que el cable se enrede **New Gyroscopic Navigation System to improve navigation of the robot, maximize efficacy and prevent cable tangling** Nouveau système de navigation qui maximise le cycle de lavage et empêche câble enchevêtrement Nuovo sistema di navigazione che massimizza il ciclo di lavaggio e previene l'aggravamento del cavo
2. **Floor & Walls:** Limpia el suelo y las paredes de la piscina **Cleans the floor and the wall of the pool** Nettoie le fond et les parois de la piscine Pulisce fondo e pareti della piscina
3. **Top access:** Filtro de acceso superior **Top access filter** Filtre facile à nettoyer avec le système top access **Acceso al filtro nella parte superiore del robot**
4. **Max scrubber:** Cepillo rotativo de gran velocidad **Fast moving brush** Brosse rotative de grande vitesse **Spazzola rotante di grande velocità**
5. **Easy view:** Ventana transparente para ver el filtro **Transparent window for seeing inside the filters** Système easy view pour avoir un aperçu sur le niveau de remplissage du filtre **Finestrella trasparente per controllare meglio la situazione del filtro**
6. **4x4:** Tecnología 4x4 patentada con un sólo motor de tracción **4x4 patented technology with only one drive motor** Système de traction 4x4 breveté avec 1 seul moteur pour une longévité accrue **Tecnología 4x4 brevettata con un solo motore di trazione**
7. **Plug&Play:** Conectar y listo para usar **Put the robot in the water and it's ready to clean** Prêt à fonctionner **Una volta collegato è pronto per lavorare**
8. **Easy clean:** Filtro fácil y rápido de limpiar **Filter that enables quick and easy cleaning** Facilité d'accès pour nettoyer le robot **Filtro facile e rapido da pulire**
9. **Light:** Robot ligero **Light robot** Robot léger **Leggero**
10. **Filter check:** Indicador de filtro lleno mediante LED **Full filter LED indicator** Indicateur LED dans le transformateur indiquant que le filtre est plein **Indicatore filtro pieno mediante un LED luminoso**

# material de limpieza

# cleaning material

## KAYAK ADVENTURE COMPACT

REF. RKA80C

15 m

CBX PACK 1



El Kayak Adventure Compact se adapta a todo tipo de piscinas hasta 100m<sup>2</sup> de superficie. Limpia el fondo y las paredes de su piscina.

Le robot Kayak Adventure Compact convient pour tout type de piscine d'une superficie jusqu'à 100m<sup>2</sup>. Il nettoie le fond et les parois.

The Kayak Adventure Compact adapts to all types of pools measuring up to 100m<sup>2</sup> in surface area, cleaning the bottom and walls.

Il Robot Kayak Adventure Compact si adatta a tutti i tipi di piscine fino a 100m<sup>2</sup> di superficie, pulendo il fondo e le pareti.

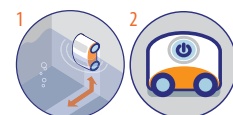

**1. Floor & Walls:** Limpia el suelo y las paredes de la piscina Cleans the bottom and walls Nettoie le fond et les parois de la piscine Pulisce fondo e pareti della piscina  
**2. Plug&Play:** Conectar y listo para usar Put the robot in the water and it's ready to clean Prêt à fonctionner Una volta collegato è pronto per lavorare

## TRACK 1

REF. RT1S

15 m

CBX PACK 1



El Track 1 se adapta a todo tipo de piscinas hasta 60m<sup>2</sup> de superficie y limpia el suelo y la media caña de piscinas con borde curvo.

Le Track 1 s'adapte à toutes les piscines de jusqu'à 60m<sup>2</sup> de surface et il permet de nettoyer le fond et les bords arrondis des piscines.

The Track 1 adapts to all types of pools measuring up to 60m<sup>2</sup> in surface area, cleaning the floor and the half tube with curved edge.

Il Track 1 si adatta a tutte le tipologie di piscine fino a 60m<sup>2</sup> di superficie e pulisce il fondo e le stonature delle pareti delle piscine a bordo curvo.

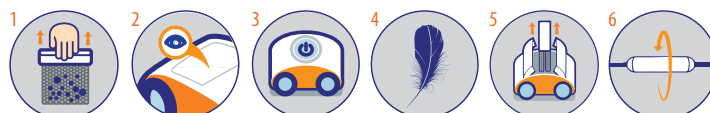

**1. Easy clean:** Filtro fácil y rápido de limpiar Filter that enables quick and easy cleaning Facilité d'accès pour nettoyer le robot Filtro facile e rapido da pulire  
**2. Easy view:** Ventana transparente para ver el filtro Transparent window for seeing inside the filters Système easy view pour avoir un aperçu sur le niveau de remplissage du filtre Finestrella trasparente per controllare meglio la situazione del filtro  
**3. Plug&Play:** Conectar y listo para usar Put the robot in the water and it's ready to clean Prêt à fonctionner Una volta collegato è pronto per lavorare  
**4. Light:** Robot ligero Light robot Robot léger Leggero  
**5. Top access:** Filtro de acceso superior Top access filter Filtre facile à nettoyer avec le système top access Accesso al filtro nella parte superiore del robot  
**6. Anti-tangle system:** Sistema anti-enredo para un funcionamiento óptimo With anti-tangle system allowing optimal performance Système « anti-emmêlement » pour un rendement optimal Sistema "anti-impigliamento" che consente un'ottima resa



# matériel de nettoyage materiale di pulizia



## KAYAK CLEVER

REF. RKC100J

12 m

CBX PACK 1



El Kayak Clever limpia el fondo inclinado o plano de piscinas hasta 60m<sup>2</sup> de superficie.

Le robot Kayak Clever RKC100J convient pour tout type de piscine à fond plat ou pente douce d'une superficie jusqu'à 60m<sup>2</sup>.

The Kayak Clever adapts to all types of pools measuring up to 60m<sup>2</sup> in surface area, cleaning the bottoms whether they are flat or inclined.

Il Robot Kayak Clever RKC100J si adatta a tutti i tipi di piscine fino a 60m<sup>2</sup> di superficie, pulendo il fondo in piano che inclinato.



## KAYAK JET BLUE

REF. RKJ14

12 m

CBX PACK 1



El Kayak Jet Blue limpia el fondo inclinado o plano de piscinas hasta 60m<sup>2</sup> de superficie.

Le robot Kayak Jet Blue convient pour tout type de piscine à fond plat ou pente douce d'une superficie jusqu'à 60m<sup>2</sup>.

The Kayak Jet Blue adapts to all types of pools measuring up to 60m<sup>2</sup> in surface area, cleaning the bottoms whether they are flat or inclined.

Il Robot Kayak Jet Blue si adatta a tutti i tipi di piscine fino a 60m<sup>2</sup> di superficie, pulendo il fondo in piano che inclinato.

**1. Plug&Play:** Conectar y listo para usar Put the robot in the water and it's ready to clean Prêt à fonctionner Una volta collegato è pronto per lavorare

**2. Light:** Robot ligero Light robot Robot Léger Leggero

**3. Top access:** Filtro de acceso superior Top access filter Filtre facile à nettoyer avec le système top access Accesso al filtro nella parte superiore del robot

## RECAMBIOS BOLSA FILTRANTE SPARE FILTRATION BAGS RECHARGES SAC POUR ROBOTS RICAMBI SACCO FILTRO

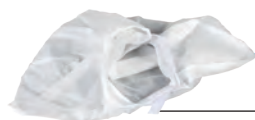

3 bolsas recambio desechables para robot  
Sac jetable pour robot - carton de 3 pièces

Non-returnable spare filtration bag - 3 units  
Busta per robot usa e getta - scatola di 3 unità

REF. 40684

CBX pack 8



## LIMPIAFONDOS ELÉCTRICOS ELECTRIC CLEANERS

### NETTOYEUR DE FOND ÉLECTRIQUE PULITORE ELETTRICO PER FONDO PISCINA

Los limpiafondos eléctricos son una solución cómoda y sencilla para la limpieza de la piscina. Son recargables, sin necesidad de cables y muy manejables debido a su tamaño y forma.

Les nettoyeurs de fond électriques sont une solution pratique et simple pour le nettoyage des piscines. Ils sont rechargeables, sans besoin de câbles et très faciles à utiliser en raison de leur taille et de leur forme.

Electric cleaners are a convenient and simple solution for cleaning the pool. They are rechargeable, wirelessly and very manageable because of its size and shape.

I pulitori elettrici per fondo piscina rappresentano una soluzione comoda e semplice per la pulizia della piscina. Sono ricaricabili, non necessitano di cavi e sono maneggevoli grazie alle loro dimensioni e alla forma.



#### ELECTRIC VAC PLUS

REF. VCB50

CBX PACK 1



8 4 1 2 0 8 1 2 7 2 5 2 8

Limpiafondos eléctrico autónomo - Potencia: 36 W. Se puede utilizar con su propio mango o conectado a un mango telescópico estándar para facilitar su uso en piscinas más profundas. Recargable, sin cables. Incluye 3 baterías recargables litio (4000mah/11,1V). Potencia de succión: 90 l/h. Tiempo de trabajo: 90 minutos. Ligero, fácil de manejar.

Nettoyeur électrique autonome -Puissance: 36 W. Il peut être utilisé avec sa propre poignée ou attaché à une poignée télescopique standard pour faciliter son utilisation dans des bassins plus profonds. Rechargeable, sans câbles. Comprend 3 batteries rechargeables au lithium (4000mah / 11.1V). Puissance d'aspiration: 90 l / h. Temps de travail: 90 minutes. Léger, facile à manipuler.

Autonomous electric cleaner – Power: 36 W. Can be used with its own handle or connected to a standard telescopic handle for ease use in deeper pools. Rechargeable, without cables. It includes 3 rechargeable lithium batteries (4000mah/11.1V). Suction power: 90 l/h. Working time: 90 minutes. Lightweight, easy to handle.

Pulitore elettrico autonomo - Potenza: 36 W. Si può usare con il manico in dotazione o collegato ad un'asta telescopica per agevolare il suo utilizzo in piscine più profonde. Ricaricabile, senza cavo. Include 3 batterie ricaricabili litio. (4000mah/11,1V). Potenza di assorbimento: 90 l/h. Tempo di lavoro: 90 minuti. Leggero, facile da maneggiare.



#### ELECTRIC VAC

REF. VCB10

CBX PACK 2



8 4 1 2 0 8 1 2 6 3 2 9 8

Especialmente indicado para piscinas enterradas, limpia las escaleras y esquinas donde el limpiafondos automático no llega. Posee un depósito removible de gran capacidad e incorpora un filtro que retiene partículas de pequeño tamaño. Ligero y de fácil manejo. Recargable y sin cables: funciona con batería de litio recargable de 11,1 V. Posibilidad de uso con su propio asa o conectándolo a una pértiga.

Spécialement conçu pour les piscines enterrées. Il nettoie les escaliers et les angles, contrairement au nettoyeur de fond automatique. Il est muni d'un réservoir amovible de grande capacité et il incorpore un filtre qui retient les particules de petite taille. Léger et facile à manipuler. Rechargeable et sans câbles : il fonctionne avec un accumulateur lithium rechargeable de 11,1 V. Il peut être utilisé avec sa poignée ou bien connecté à une perche.

Especially indicated for embedded pools, cleans stairs and corners where automatic cleaners do not reach. It has a large capacity removable tank and includes a filter to retain small-size particles. Lightweight and easy to use. Rechargeable and without cables: operates with an 11.1 V lithium battery. Possibilities of use with its own handle or connected to a pole.

Particolarmente indicato per piscine interrate, pulisce le scalette e gli angoli che il pulitore automatico non riesce a raggiungere. È dotato di un capiente serbatoio removibile e di un filtro in grado di trattenere le particelle più piccole. Leggero e maneggevole. Ricaricabile e senza fili: funziona con batteria al litio ricaricabile da 11,1V.

# matériel de nettoyage

# materiale di pulizia



## POOL & SPA VAC

REF. CSPA

CBX PACK 6



8 412081 265315

Limpiafondos para piscinas y spas con mango. Recargable y sin cables. Posibilidad de uso con su propio mango o conectado a una pértiga. Ligero y manejable.

Nettoyeur de fonds pour piscines et spas avec manche. Rechargeable et sans câbles. Il peut être utilisé avec sa poignée ou bien connecté à une perche. Léger et facile à manipuler.

Pool and spa vac with handle. Rechargeable and without cables. Possibilities of use with its own handle or connected to a pole. Lightweight and easy to use.

Pulitore per fondo piscina e spa con manico. Ricaricabile e senza fili. Può essere utilizzato con il manico in dotazione o collegato a un'asta.



## STICK VAC

REF. VCB08

CBX PACK 2



8 412081 272535

Limpiafondos eléctrico para piscinas y Spa. Limpiador eléctrico autónomo - Potencia: 10 W. Sin cables. Necesita 8 baterías AA. Poste de extensión de 1,65 m incluido. Peso ligero, fácil manejo. Sin cables.

Nettoyeur de piscine et de spa électrique. Nettoyeur électrique autonome - Puissance: 10 W. Sans câbles. Nécessite 8 piles AA. Poste d'extension de 1,65 m inclus. Poids léger, manipulation facile. Pas de câbles.

Pool and spa electric cleaner. Autonomous electric cleaner - Power: 10 W. Without cables. 8 pieces of AA battery needed. Extension pole of 1,65 m included. Lightweight, easy to handle. Without cables.

Pulitore elettrico per piscine e Spa. Pulitore elettrico autonomo - Potenza: 10 W. Senza cavo. Necessita di 8 batterie AA. Asta estensibile di 1,65 m inclusa. Peso leggero, facile da maneggiare. Senza cavi.



NEW



REF. ABS3

CBX PACK 1



8 412081 265315

Limpiafondos de batería para piscinas y spas con mango telescópico. Sin cables. Pértiga extensible de 133 cm incluida. Ligero y manejable.

Nettoyeur de fond à batterie pour piscines et spas avec manche télescopique. Sans câbles. Perche extensible de 133 cm incluse. Léger et maniable.

Battery powered pool and spa cleaner with telescopic handle. No cables. Extendible handle of 133 cm included. Light-weight and easy to handle.

Puliscifondo a batteria per piscine e spa con manico telescopico. Senza fili. Prolunga per manico estensibile da 133 cm inclusa. Leggero e maneggevole.

## LIMPIAFONDOS AUTOMÁTICOS AUTOMATIC CLEANERS NETTOYEURS AUTOMATIQUES PULISCIFONDI AUTOMATICI

### ACROBAT

REF. ACD10

9m - Ø 38

CBX PACK 1



Limpiafondos automático de membrana. Limpia el fondo y las paredes de cualquier piscina. Funciona con sistemas de filtración de una potencia mínima de 1/2CV.

Nettoyeur automatique avec système unique de membrane. Nettoie le fond et les parois de la piscine. Il fonctionne avec des systèmes de filtration d'une puissance minimum de 1/2cv.

Automatic pool cleaner with membrane system. The Professional Vac cleans the bottom and walls of your pool. Works with 1/2 hp minimum.

Puliscifondo automatico con sistema a membrana. Il Professional Vac pulisce il fondo e le pareti della piscina. Funziona con sistemi di filtrazione che hanno una potenza minima di 1/2cv.



### PROFESSIONAL VAC

REF. 19007

9,6m - Ø 38

CBX PACK 1



Limpiafondos automático de membrana. Limpia el fondo y las paredes de cualquier piscina. Funciona con sistemas de filtración de una potencia mínima de 0,33CV.

Nettoyeur automatique avec système unique de membrane. Nettoie le fond et les parois de la piscine. Il fonctionne avec des systèmes de filtration d'une puissance minimum de 0,33cv.

Automatic pool cleaner with membrane system. The Professional Vac cleans the bottom and walls of your pool. Works with 0,33 hp minimum.

Puliscifondo automatico con sistema a membrana. Il Professional Vac pulisce il fondo e le pareti della piscina. Funziona con sistemi di filtrazione che hanno una potenza minima di 0,33cv.



# matériel de nettoyage materiale di pulizia



Max. 1,80m



## SILENCE VAC

REF. 90397

9,6m - Ø 38

CBX PACK 2



8 427370 903977

Limpiafondos automático más silencioso que los sistemas tradicionales de "martillo". Limpia el fondo y las paredes de su piscina. Funciona con sistemas de filtración de una potencia mínima de ½cv y máxima de 1½cv.

Automatic pool cleaner which is quieter than the traditional "hammer" systems. The Silence Vac cleans the bottom and walls of your pool. Works with ½ hp minimum and 1½hp maximum power filtration systems.

Nettoyeur automatique plus silencieux que les systèmes traditionnels à "marteau". Nettoie le fond et les parois de la piscine. Il fonctionne avec des systèmes de filtration d'une puissance minimum de ½cv et maximale de 1½cv.

Puliscifondo automatico più silenzioso dei sistemi tradizionali a "martello". Il Silence Vac pulisce il fondo e le pareti della piscina. Funziona con sistemi di filtrazione che hanno una potenza minima di ½cv e massima di 1½cv.



## CLASSIC VAC

REF. 19001

8m - Ø 38

CBX PACK 1



8 427370 190018

Limpiafondos automático para piscinas enterradas y elevadas dotadas de un equipo de filtración con una bomba de una potencia mínima de 3/4 cv.

Automatic pool cleaner for in ground and above ground pools equipped with filtering equipment with a minimum power pump of 3/4 hp.

Nettoyeur automatique de piscines enterrées et hors-sol équipé d'une filtration avec une pompe d'une puissance minimum de 3/4cv.

Puliscifondo automatico per piscine interrate e fuori terra dotate di un sistema di filtrazione con una potenza minima di 3/4 cv.



## WIKI VAC

REF. 90399

6m - Ø 32

CBX PACK 2



Limpiafondos automático para piscinas autoportantes y elevadas. Funciona con equipos de filtración de baja potencia: a partir de 0,1cv. Dispone de un prefiltro exclusivo que permite proteger el cartucho y la filtración.

Nettoyeur automatique pour piscines autoportantes et hors-sol. Il fonctionne avec des filtrations de très faible puissance: à partir de 0,1cv minimum. Il dispose d'un préfiltre exclusif qui protège la cartouche et la filtration.

The automatic pool cleaner for inflatable or above ground pools. Works with low-power filtering equipment: ranging from 0.1hp. It has a unique pre-filter which protects the cartridge and filtration.

Puliscifondo per piscine autoportanti e fuoriterra. Funziona con un sistema di filtrazione a partire da 0,1 cv di potenza. È dotato di un prefiltro esclusivo che permette una maggior cura della cartuccia e della filtrazione.



## SMALL CONFORT

REF. AR20682

6m - Ø 32

CBX PACK 4



Limpiafondos automático por aspiración. Se conecta directamente al skimmer y es compatible con bombas a partir de 1/3CV.

Nettoyeur de fond automatique par aspiration. Il se branche directement sur le skimmer et il est compatible avec des pompes à partir de 1/3 de CV.

Automatic suction pool cleaner that is directly connected to the skimmer. Compatible with pumps from 1/3HP.

Puliscifondo automatico ad aspirazione. Si collega direttamente allo skimmer ed è compatibile con pompe a partire da 1/3CV.



REF. PFAC17

CBX PACK 4



Prefiltro para limpiafondos de aspiración. Conector de manguera giratorio incluido. Contenedor transparente que permite saber cuándo está lleno. Capacidad de 1,7 litros.

Préfiltre pour aspirateur. Raccord de tuyau rotatif inclus. Conteneur transparent qui vous permet de savoir quand il est plein. Capacité de 1,7 litres.

Pre-filter to be used with suction cleaners. Swivel hose connector included. Clear container allows to see when basket is full. 1,7 liters capacity.

Prefiltro per Puliscifondo. Connettore per tubo flessibile incluso. Contenitore trasparente che ti consente di sapere quando è pieno. Capacità di 1,7 litri.



**LIMPIAFONDOS DE ASPIRACIÓN MANUAL VACUUM CLEANERS  
NETTOYEURS ASPIRANTS PULITORI AD ASPIRAZIONE MANUALE**

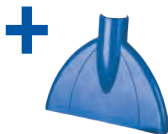

**MEDIUM VAC**

REF. AR20637

9m - Ø 32

CBX PACK 6



8 412081 231099

Kit de mantenimiento para piscinas autoportantes o elevadas. Contiene dos boquillas (una de ellas con cepillo).

Le Kit d'entretien pour piscines autoportantes ou hors-sol. Contient: un aspirateur de fond à aspiration manuelle qui inclut deux embouts.

Maintenance kit for inflatable or above ground pools. The pool cleaner includes: two suction nozzles, one with a brush.

Kit di mantenimento per piscine autoportanti o fuori terra. Contiene due aspiratori, uno con pennello



**LITTLE VAC**

REF. 08011A

5m - Ø 32

CBX PACK 6



8 427370 080111

Kit de mantenimiento para piscinas autoportantes o elevadas.

Le Kit d'entretien pour piscines autoportantes ou hors-sol.

Maintenance kit for inflatable or above ground pools.

Kit di mantenimento per piscine autoportanti o fuori terra.



**REF. PSV51**

CBX PACK 6



8 412081 250137

Pool & Spa Vac: Limpiafondos manual con accesorios Incluye: recogedor superficie, boquilla ancha aspiración, cepillo acoplable, soporte para pared.

Pool & Spa Vac: Nettoyeur de fond manuel avec accessoires Il inclut: un ramasseur de surface, un bec large d'aspiration, une brosse et un support pour le mur.

Pool & Spa Vac: Includes: Leaf net+ Suction nozzle+ Attachable brush + Wall bracket.

Pool & Spa Vac: Puliscifondo manuale con accessori Include: rete foglie, bocchetta di aspirazione, spazzola, staffa per muro.

## KITS LIMPIAFONDOS VACUUM CLEANER KITS

### KIT NETTOYEUR ASPIRANTS KIT PULITORI FONDO AD ASPIRAZIONE

REF. AR20641

CBX PACK 2



Limpiafondos para pértiga + pértiga 3 secciones + recogedor de fondo + termómetro flotante + dosificador oval + cepillo para liner + manguera 6m + bote de tiras reactivas (tester)

Pack d'entretien comprenant: un nettoyeur de fond pour manche + perche 3 sections + épuisette de fond + thermomètre flottant + doseur ovale pour galets de 200gr + brosse pour liner + 6m tuyau + boîte de bandelettes de test (tester)

Bottom cleaner for pole + 3 section pole + leaf rake + floating thermometer + oval dispenser + brush for liner + 6m hose + can of reactive test strips (tester)

Puliscifondi + pertica 3 sezioni + raccogliore di fondo + termometro galleggiante + dosatore ovale + spazzola per liner + 6m tubo + confezione da strisce reattive (tester)



REF. AR2064

CBX PACK 4



Kit limpiafondos + pértiga 3,60m (3x1,20m) + manguera 6m

Kit nettoyeur + manche 3,60m (3x1,20m) + tuyau 6m

Vacuum head kit + handle 3,60m (3x1,20m) + 6m hose

Kit puliscifondo + pertica 3,60m (3x1,20m) + tubo 6m



REF. KMA05

CS PACK 6



Kit mantenimiento piscinas: analizador pH/Cl, cepillo 45 cm, recogehojas superficie, termómetro y limpiafondos

Kit de nettoyage pour piscines: analyse pH/Cl, brosse 45 cm, épuisette de surface, thermomètre et balai manuel

Pool maintenance kit: pH/Cl Test kit, 45 cm Brush, leaf net, thermometer and Vacuum head

Kit di mantenimento per piscine: analizzatore ph/cl, spazzola 45 cm, raccogliore di superficie, termometro e puliscifondo



REF. KMSPA

CS PACK 6



Kit mantenimiento para spa hinchable o rígido. Incluye: Recogehojas · cepillo · Esponja de la línea de flotación · Pértiga

Kit d'accessoires pour spa gonflable ou rigide. Le kit comprend: Une épuisette · Une brosse · Eponge ligne d'eau · Manche

Maintenance kit for Inflatable and rigid spas. Includes: Leaf skimmer · Brush · Water line cleaner sponge · Pole

Mantenimento per spa gonfiabili o parete rigida. Include: Raccogliore · Spazzola · Spugne per la linea di galleggiamento · Pertica





# matériel de nettoyage materiale di pulizia

## LIMPIAFONDOS VENTURY VENTURY VACUUM ASPIRATEURS DE FOND VENTURY PULISCIFONDI VENTURY



REF. 08050

CS PACK 6



Kit piscina autoportante: analizador pH/Cl, cepillo, recogehojas de superficie, mango 1,20m (3 tramos) termómetro tubular, dosificador y jet vac ventury.

Kit spécial piscine autoportante: trousse d'analyse pH/Cl, brosse, époussette de surface, manche 1,20m (3 parties), thermomètre tubulaire, doseur pastilles rétractable and jet vac ventury.

Special inflatable pool kit: pH/chlorine test kit, brush, leaf net, tubular thermometer, 1,20m handle (3 sections), fl oating dispenser and ventury vacuum.

Kit speciale per piscina autoportante: analizzatore pH/Cl, spazzola, Raccogliitore di superficie, manico 1,20m (3 sezioni) termometro tubolare, dosatore e aspiratore jet vac ventury.



REF. 90111

DIS 3/4N PACK 8



Limpiafondos Micro-Ventury.  
Nettoyeur Micro-Venturi.

Micro-Ventury Vacuum.  
Puliscifondi Micro-Ventury.



REF. Y15

CBX PACK 12



Kit limpiafondos Ventury+ pértiga.  
Kit Aspirateur de fond Venturi + manche.

Ventury vacuum kit + handle.  
Aspiratore Ventury+ pertica.



REF. Y12

CS PACK 50



2 filtros para limpiafondos ventury  
2 filtres pour aspirateur de fond

2 filters for ventury bottom cleaner  
2 filtri per puliscifondo venturi

material de limpieza

cleaning material

**SERIE GRAPHITE GRAPHITE SERIE**  
**GAMME GRAPHITE GAMMA GRAPHITE**



Recogehojas de superficie  
Époussette de surface

Leaf net  
Raccoglitore di superficie

REF. LSP40

CB PACK 6



Recogehojas de fondo  
Époussette de fond

Leaf rake  
Raccoglitore di fondo

REF. LRP40

CB PACK 6



Limpiafondos triangular  
Balai triangulaire

Triangular suction pool cleaner  
Puliscifondo triangolare

REF. VHTR40

CB PACK 6



Limpiafondos rectangular  
Balai rectangulaire

Vacuum head rectangular  
Puliscifondo rettangolare

REF. VHTR40

CB PACK 6



Ø 5x360 cm  
Mango telescópico de aluminio  
Manche télescopique argenté

Telescopic aluminium handle  
Manico telescopico argentato

REF. TPP360

CB PACK 6



# matériel de nettoyage materiale di pulizia



Cepillo 45 cm  
Brosses 45 cm

45 cm brushes  
Spazzole 45 cm

REF. WBP45

CS PACK 6



8 412081 302812



Cepillo 25 cm  
Brosses 25 cm

25 cm brushes  
Spazzole 25 cm

REF. WBP25

CS PACK 6



8 412081 302829



Dosificador flotante  
pastillas 250gr  
Doseur pastilles  
flottant 250 g

Tablets floating  
dispenser 250gr  
Dosatore galleggiante  
pastiglie da 250 g

REF. FDP250

CB PACK 12



8 412081 302843



Dosificador flotante  
pastillas 20gr  
Doseur pastilles  
flottant 20 g

Tablets floating  
dispenser 20gr  
Dosatore galleggiante  
pastiglie da 20 g

REF. FDP20

CB PACK 12



8 412081 302850



Cepillo manual  
multifunción  
Brosse manuelle  
multifonction

Multi-function  
manual brush  
Spazzola manuale  
multifunzione

REF. HBP20

CS PACK 6



8 412081 302805



Termómetro digital  
flotante  
Thermomètre digital  
flottant

Floating digital  
thermometer  
Termometro digitale  
galleggiante

REF. THP24

CS PACK 24



8 412081 302836

material de limpieza

cleaning material

**GAMA CONFORT CONFORT RANGE**  
**GAMME CONFORT GAMMA CONFORT**

Recogehojas de superficie  
Gama confort  
Époussette de surface  
Gamme confort

Confort range  
Leaf net  
Raccogliatore di superficie  
Gamma confort



REF. 40030N

DISPACK 12



8 4 12081 272962

Recogehojas de fondo  
Gama confort  
Époussette de fond  
Gamme confort

Confort range  
leaf rake  
Raccogliatore di fondo  
Gamma confort



REF. 40032N

DIS PACK 12



8 4 12081 272955

Recogehojas superficie  
aluminio  
Époussette de surface  
aluminium

Aluminium  
Leaf net  
Raccogliatore di superficie  
alluminio



REF. RHSALN

DIS PACK 12



8 4 12081 272979

Recogehojas fondo  
aluminio  
Époussette de fond  
aluminium

Aluminium  
Leaf rake  
Raccogliatore di fondo  
alluminio



REF. RHFALN

DIS PACK 12



8 4 12081 272986

Termómetro UFO  
Thermomètre UFO

UFO thermometer  
Termometro UFO



REF. TTUFO

DIS PACK 12



8 4 12081 273068

Colgador metálico para  
material de limpieza  
Cintre en métal pour le  
rangement du matériel

Metalic hanger for  
cleaning material  
Portautensili metallico per  
attrezzi di pulizia



REF. BHM5

BX PACK 6



8 4 12081 273075

# matériel de nettoyage materiale di pulizia



Cepillo 45 cm  
Brosses 45 cm

45 cm brushes  
Spazzole 45 cm

REF. 40041N

DIS PACK 12



8 4 1 2 0 8 1 2 7 3 0 1 3



Cepillo 25 cm  
Brosses 25 cm

25 cm brushes  
Spazzole 25 cm

REF. 40041SN

DIS PACK 12



8 4 1 2 0 8 1 2 7 3 0 2 0



Cepillo aluminio  
Gran formato 45 cm  
Brosse aluminium  
Grand Format 45 cm

Big Format 45 cm  
Aluminium brush  
Spazzola alluminio  
Gran Formato 45 cm

REF. 40046N

DIS PACK 12



8 4 1 2 0 8 1 2 7 2 9 9 3



Limpiafondos triangular  
rotativo con cepillos  
Balai triangulaire  
rotatif avec brosses

Triangular swivelling vac  
head with brushes  
Puliscifondo triangolare  
rotante con spazzole

REF. 40016N

DIS PACK 4



8 4 1 2 0 8 1 2 7 3 0 4 4



Limpiafondos ovalado  
rotativo con cepillos  
Balai oval rotatif avec  
brosses

Oval swivelling vac head  
with brushes  
Puliscifondo ovale rotante  
con spazzole

REF. 40017N

DIS PACK 6



8 4 1 2 0 8 1 2 7 3 0 3 7



Limpiafondos manual rotativo 8  
ruedas con cepillos laterales  
Balai manuel rotatif 8 roues  
avec brosses latérales

Swivelling vacuum head 8  
wheels with lateral brushes  
Puliscifondo manuale con 8  
ruote e spazzole laterali

REF. 40018N

DIS PACK 6



8 4 1 2 0 8 1 2 7 3 0 5 1



Cepillo manual  
multifunción  
Brosse manuelle  
multifonction

Multifunctional manual  
brush  
Spazzola manuale  
multifunzione

REF. 40040N

DIS PACK 12



8 4 1 2 0 8 1 2 7 3 0 0 6

material de limpieza

cleaning material

## RECOGEHOJAS LEAF NETS AND RAKES ÉPUISETTES RACCOGLITORI

Recogehojas de fondo  
+ mango telescópico  
Épuiette de fond  
+ manche télescopique

Leaf rake  
+ telescopic handle  
Raccoglitore di fondo  
+ Manico telescopico

REF. 40031F

CB PACK 12



Recogehojas de superficie  
+ mango telescópico  
Épuiette de surface  
+ manche télescopique

Leaf net  
+ telescopic handle  
Raccoglitore di superficie  
+ Manico telescopico

REF. 40031

CB PACK 12



## LIMPIAFONDOS MANUALES VACUUM HEADS BALAIS MANUELS PULISCIFONDO MANUALI

Limpiafondos de aluminio  
Balai en aluminium

Aluminium vac head  
Alluminio puliscifondo

REF. 40022

BX PACK 6

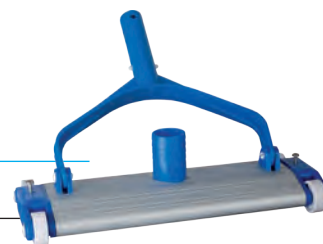

Empuñadura clip Ø28mm  
Poignée clip Ø28mm

Clip handle Ø28mm  
Impugnatura clip Ø28mm

REF. 40092

DIS 1/4N pack 20

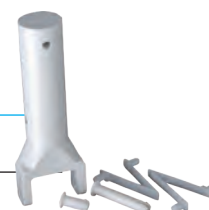

# matériel de nettoyage materiale di pulizia

## CEPILLOS BRUSHES BROSSES SPAZZOLE



Cepillo aluminio para  
eliminar algas  
Brosse aluminium pour  
éliminer les algues

Aluminium brush to  
eliminate the algae  
Spazzola alluminio  
per eliminare le alghe



REF. CAA25

DIS 1/4N pack 16



8 412081 241456



Cepillo aspirante  
Brosse aspirante

Vacuum brush  
Spazzola con attacco per aspirare



REF. 40802

DIS 3/4N pack 10



8 427370 408021



Cepillo aspirador limpia-esquinas  
Brosse aspirante d'angle

Corners-cleaner vacuum brush  
Spazzola aspiratutto per angoli



REF. 40806

DIS 1/4N pack 18



8 427370 408069

**TERMÓMETROS THERMOMETERS**  
**THERMOMÈTRES TERMOMETRI**

Termómetro pez payaso  
Thermomètre de poisson clown

Clown fish thermometer  
Termometro pesce pagliaccio



REF. TBF20

BXL PACK 12



Termómetro bola  
Thermomètre boule

Ball thermometer  
Termometro a sfera



REF. 40055

CB pack 15



Termómetro boya  
Thermomètre bouée

Buoy thermometer  
Termometro galleggiante



REF. 40054

DIS 1/2N pack 10



Termómetro tubular flotante  
Thermomètre flottant tubulaire

Tubular floating thermometer  
Termometro tubolare



REF. 40051

DIS 1/2N PACK 18



Termómetro "Big"  
Doble lectura  
"Big" Thermomètre  
Double lecture

"Big" thermometer  
Double reading  
Termometro "Big"  
Doppio lettura



REF. 40050

CS pack 12





# matériel de nettoyage materiale di pulizia



Box mixto de termómetros pez versión standard y versión Led.

Box mixte de thermomètres poisson version standard et version Led.

Mixed box with standard and LED version fish thermometers.

Contenitore con misto di termometri a forma di pesce in versione standard e led.

REF. BT474

BXL pack 1



## MANGOS TELESCÓPICOS TELESCOPIC HANDLES MANCHES TÉLESCOPIQUES MANICO TELESCOPICO



Mango telescópico de aluminio  
Manche télescopique argenté  
**3,60 m (3 x 1,20m)**

Telescopic aluminium handle  
Manico telescopico argentato

REF. 40014

BX pack 12



Mango telescópico de aluminio  
Manche télescopique argenté  
**4,80 m (2 x 2,40m)**

Telescopic aluminium handle  
Manico telescopico argentato

REF. 40011

BX pack 10



Mango telescópico de aluminio  
Manche télescopique argenté  
**3,60 m (2 x 1,80m)**

Telescopic aluminium handle  
Manico telescopico argentato

REF. 40010

BX pack 10



Mango telescópico de aluminio  
Manche télescopique argenté  
**2,40 m (2 x 1,20m)**

Telescopic aluminium handle  
Manico telescopico argentato

REF. 40013

BX pack 20



material de limpieza

cleaning material

## DOSIFICADORES DISPENSERS DOSEURS DOSATORI

Combi Thermo-dosificador:  
Dosificador Capacidad 1,5 Kg  
(pastillas de 20 a  
500 g) + Termómetro + Visor  
de consumo de producto

Combi Thermo-doseur: Doseur  
Capacité 1,5 Kg (pastilles de  
20 à 500 g) + Thermomètre +  
Témoin de consommation de  
produit

Combi Thermo-dosifier:  
Dosifier Capacity 1,5 kg (20  
500 g tablets) +  
Thermometer + Product  
Consumption Viewer

Combi Thermo-Dosatore  
Capacità 1,5 kg (Tavolette da  
20 a 500 g)  
+ Termometro + Controllo  
livello del prodotto



REF. 40070

DIS 1/2N PACK 5



Combi Thermo-dosificador:  
Dosificador pastillas de 20 g +  
Termómetro + Visor de consumo  
de producto

Combi Thermo-doseur:  
Doseur pastilles de 20 g +  
Thermomètre + Viseur de  
consommation de produit

Combi Thermo-dosifier:  
Dosifier 20g tablets +  
Thermometer + Product  
Consumption Viewer

Combi Thermo-Dosatore  
Tavolette da 20 g +  
Termometro + Controllo  
livello del prodotto



REF. DCT20

DIS 1/2N PACK 36



Dosificador flotante.  
Capacidad: 7 pastillas de 20 g  
Doseur flottant.  
Capacité 7 pastilles de 20 g

Floating dispenser.  
Capacity: 7 tablets 20 g  
Dosatore galleggiante.  
Capacità 7 pastiglie da 20 g



REF. 40071

DIS 1/2N PACK 30



# matériel de nettoyage materiale di pulizia

**BOX**

REF.786498

DIS PACK 1



REF	N°	Descripción. Describe. Désignation. Descrizione	CTD	EAN 13
778191	1	Dosificador. Dispenser. Diffuseur. Desatore	24	3 605217 781918
621201	2	Kit reparación liner. Liner repair kit. Kit réparation liner. Kit riparazione liner	36	3 605216 212017
777580	3	Recogehojas fondo. Leaf rake. Épuisette de fond. Raccogliatore di fondo	20	3 605217 775801
770311	4	Aspirador efecto venturi+bolsa. Jet vac with brush+bag. Aspirateur effet venturi +beutel. Aspiratore effetto venturi	6	3 605217 703118
783810	5	Recogehojas superficie. Leaf net. Épuisette surface. Raccogliatore superficie	12	3 605217 838100
772804	6	Recogehojas superficie PVC. PVC Leaf net. Épuisette surface PVC. Raccogliatore superficie PVC	20	3 605217 728043
778201	7	Termómetro 16 cm. thermometer 16 cm. Thermomètre 16 cm. Termometro 16 cm.	33	3 605217 782014
770340	8	Cepillo manual. Hand brush. Brosse à main. Spazzola manuale	21	3 605217 703408
770326	9	Termómetros animal. Animals thermometer. Thermomètre animaux. Termometro animale	12	3 605217 703262
772876	10	Cepillo de pared 45 cm. 45 cm wall brush. Brosse de paroi 45 cm. Spazzola parete 45 cm	12	3 605217 728760
777917	11	Lavapiés. Footwash. Pédiluve. Lavapiedi	24	3 605217 779175
770342	12	Mango telescópico. Telescopic handle. Manche télescopique. Manico telescopico	16	3 605217 703422

material de limpieza

cleaning material

## CARDBOARD RANGE

Recogehojas de superficie  
clásico

Époussette de surface  
classique

Classic  
Leaf net

Raccogliatore di superficie  
classico

REF. 772804

CB PACK 12



Recogehojas de superficie  
profesional

Époussette de surface  
professionnelle

Professional  
Leaf net

Raccogliatore di superficie  
professionale

REF. 772868

CB PACK 12



Recogehojas de superficie +  
mango aluminio

Époussette de surface + manche  
aluminium

Leaf net + aluminium  
telescopic handle

Raccogliatore di superficie  
+ Manico telescopico alluminio

REF. 772869

CB PACK 12



Recogehojas fondo  
clásico

Époussette de fond  
classique

Classic  
Leaf rake

Raccogliatore di fondo  
classico

REF. 777580

CB PACK 12



Recogehojas fondo  
profesional

Époussette de fond  
professionnelle

Professional  
Leaf rake

Raccogliatore di fondo  
professionale

REF. 772872

CB PACK 12



# matériel de nettoyage materiale di pulizia



Limpiafondos triangular rotativo con cepillos  
Balai triangulaire rotatif avec brosses

Triangular swivelling vac head with brushes  
Puliscifondo triangolare rotante con spazzole



REF. 777584

CS PACK 6



3 605217 775849



Limpiafondos ovalado rotativo con cepillos  
Balai oval rotatif avec brosses

Oval swivelling vac head with brushes  
Puliscifondo ovale rotante con spazzole

REF. 770306

CS PACK 6



3 605217 703064



Limpiafondos rotativo 8 ruedas con cepillos laterales  
Balai rotatif 8 roues avec brosses latérales

Swivelling vacuum head 8 wheels with lateral brushes  
Puliscifondo con 8 ruote e spazzole laterali



REF. 777573

CS PACK 6



3 605217 775733



Limpiafondos media luna clásico  
Tête de Balai demi-lune classique

Half moon vacuum head classic  
Puliscifondo mezza luna



REF. 777970

CS PACK 6



3 605217 779700



Cepillo aluminio Gran formato 45 cm  
Brosse aluminium Grand Format 45 cm

Big Format 45 cm Aluminium brush  
Spazzola alluminio Gran Formato 45 cm



REF. 772877

CB PACK 6



3 605217 728777



Cepillo de pared clásico de 45 cm  
Brosse de paroi classique 45 cm

45 cm classic wall brush  
Spazzola parete classico 45 cm

REF. 772876

CB PACK 12



3 605217 728760

# material de limpieza

# cleaning material



Kit mantenimiento  
7 accesorios  
Kit entretien  
7 accessoires

Maintenance kit  
7 accessories  
Kit manutenzione  
7 accessori

REF. 784880

CS PACK 6



3 605217 848802



Termómetro digital  
flotante  
Thermomètre digital  
flottant

Floating digital  
thermometer  
Termometro digitale  
galleggiante



REF. 778204

CS PACK 12



3 605217 782045



Termómetros animal  
Thermomètre animaux

Animals thermometer  
Termometro animale

REF. 770326

DIS PACK 12



3 605217 703262



Esponja de la línea de  
flotación  
Eponges ligne  
d'eau

Water line cleaner  
sponges  
Spugne per la linea di  
galleggiamento

REF. 770334

CB PACK 6



3 605217 703347



Aspirador cepillo media luna  
efecto venturi + bolsa  
Aspirateur brosse demi-lune  
effekt venturi +beutel

Jet vac with brush  
and bag  
Aspiratore con spazzola a  
mezzaluna effetto venturi



REF. 772794

CS PACK 6



3 605217 727947



Bolsa de recambio aspirador  
venturi modelo pequeño  
Sac de recharge pour  
aspirateur venturi petit modèle

Replacement bag  
for jet vac  
Sacca di ricambio per aspiratore  
venturi modello piccolo

REF. 770344

PB PACK 24



3 605217 703446

# matériel de nettoyage materiale di pulizia

## BOX ECO

REF. 90197

DIS PACK 1



REF	N°	Descripción. Describe. Désignation. Descrizione	CTD	EAN 13
90128	1	Cepillo linea de agua. Waterline brush. Brosse ligne d'eau. Spazzola per bordo acqua	36	
90141	2	Dosificador de pastillas 20 gr. Tablets dispenser 20 gr. Doseur de pastilles 20gr. Dosatore pastiglie 20 gr	40	
90181	3	Recambio para analizador (Oto / Phenol). Test kit (Oto/Phenol). Recharge pur kit d'analyse (Oto/Phenol) Ricarica Oto/Phenol	60	
90140	4	Dosificador flotante de tabletas 200 gr. Tablets floatin dispenser 200 gr. Doseur de galets 200gr. Dosatore galleggiante pastiglie 200 gr	12	
90120	5	Recogehojas de fondo. Leaf rake. Epuisette de fond. Raccogliitore di fondo	16	
90115	6	Recogehojas de superficie. Leaf net. Epuisette de surface. Raccogliitore di superficie	24	
90180	7	Analizador de cloro/bromo +pH (Oto / Phenol). Test kit chlorine/bromine + pH (Oto/Phenol). Kit d'analyse chlore/brome + pH (Oto/Phenol). Kit analisi cloro/bromo + pH (Oto/Phenol)	60	
90125	8	Cepillo 20 cm. 20 cm brush. Brosse 20 cm. Spazzola 20 cm	16	
90132	9	Termómetro animal. Animal thermometer. Thermomètre animal. Termometro animale	30	
90130	10	Termómetro universal. Universal thermometer. Thermomètre universel. Termometro universale	60	

# material de limpieza

# cleaning material



## ECO RANGE

Recogehojas de superficie  
Époussette de surface

Leaf net  
Raccogliatore di superficie

REF. 90115

DIS 3/4N PACK 24



Recogehojas de superficie +  
mango 122cm  
Époussette de surface +  
manche 122cm

Leaf net + handle  
122cm  
Raccogliatore di superficie  
+ manico 122cm

REF. 90117

CB PACK 24



Recogehojas fondo  
Époussette de fond

Leaf rake  
Raccogliatore di fondo

REF. 90120

DIS 3/4N PACK 16



Recogehojas de superficie +  
mango 5secciones 160 cm  
Époussette de surface + perche  
5 sections 160cm

Leaf net + 5 section  
pole 160 cm  
Raccogliatore di superficie +  
manico sezionabile 160cm

REF. 90184

CB PACK 12



Mango telescópico  
3 x 120 cm  
Manche télescopique  
3 x 120 cm

Telescopic handle  
3 x 120 cm  
Manico telescopico  
3 x 120 cm

REF. 90100

CB PACK 10

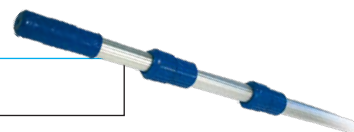

Limpiafondos 1/2 luna  
Balai demi-lune

Vacuum head  
Puliscifondo

REF. 90105

DIS 1/2N PACK 12



Aspirador cepillo media luna  
Aspirateur brosse  
demi-lune

Jet vac with brush  
Aspiratore con spazzola a  
mezzaluna

REF. 90110

DIS 3/4N PACK 8



Manguera limpiafondos 9m  
Ø38mm  
Tuyau pour nettoyeur 9m  
Ø38mm

Vacuum hose 9m  
Ø38mm  
Tubo puliscifondo 9m  
Ø38mm

REF. 90135

BX pack 1





# matériel de nettoyage materiale di pulizia



Cepillo de 45 cm Brosse 45 cm	45 cm brush Spazzola 45 cm	<b>REF. 90127</b>	<b>DIS 3/4N PACK 24</b>	 8 427370 901270
----------------------------------	-------------------------------	-------------------	-------------------------	--



Cepillo de 20 cm Brosse 20 cm	20 cm brush Spazzola 20 cm	<b>REF. 90125</b>	<b>DIS 1/4N PACK 16</b>	 8 427370 901256
----------------------------------	-------------------------------	-------------------	-------------------------	--



Cepillo línea de agua Brosse ligne d'eau	Waterline brush Spazzola per bordo acqua	<b>REF. 90128</b>	<b>DIS 1/4N PACK 36</b>	 8 427370 901287
---	---	-------------------	-------------------------	--



Termómetro universal Thermomètre universel	Universal thermometer Termometro universale	<b>REF. 90130</b>	<b>DIS 1/4N PACK 30</b>	 8 427370 901300
---	--	-------------------	-------------------------	---





Termómetros animal Thermomètre animaux	Animals thermometer Termometro animale	<b>REF. 90132</b>	<b>DIS 1/4N PACK 60</b>	 8 427370 901324
---	---	-------------------	-------------------------	--





Dosificador flotante. tabletas 200 gr Doseur de galets 200 gr	Tablets floating dispenser 200 gr Dosatore galleggiante. pastiglie 200 gr	<b>REF. 90140</b>	<b>DIS 3/4N PACK 12</b>	 8 427370 901409
--	--	-------------------	-------------------------	--



Dosificador de pastillas 20 gr Doseur de pastilles 20 gr	Tablets dispenser 20 gr Dosatore pastiglie 20 gr	<b>REF. 90141</b>	<b>DIS 3/4N PACK 40</b>	 8 427370 901416
---	---	-------------------	-------------------------	--



Analizador de cloro/bromo + pH (Oto/Phenol) Trousse chlore/brome + pH (Oto/Phénol)	Test kit chlorine/bromine + pH (Oto/Phenol) Kit analisi cloro/bromo + pH (oto/Phenol)	<b>REF. 90180</b>	<b>DIS 1/4N PACK 32</b>	 8 427370 901805
---	--	-------------------	-------------------------	--



Recambio Oto/Phenol Recharge Oto/Phénol	Test kit Oto/Phenol Ricambio Oto/Phenol	<b>REF. 90181</b>	<b>DIS 1/4N PACK 60</b>	 8 427370 901812
--	--	-------------------	-------------------------	--

material de limpieza

cleaning material

**PRODUCTOS COMPLEMENTARIOS COMPLEMENTARY PRODUCTS**  
**PRODUITS COMPLÉMENTAIRES PRODOTTI COMPLEMENTARI**



Guante con esponja  
para limpiar la línea de  
flotación

Gant avec éponge pour le  
nettoyage de la ligne de  
flottaison sur le liner

Glove with cleaning  
sponge for water line

Guanto in spugna  
per pulire la linea di  
galleggiamento

REF. GFL5

CB pack 24



8 4 1 2 0 8 1 2 6 4 4 0 0



Esponjas mágicas para  
la línea de flotación  
4 unidades

Eponges magiques  
nettoyant ligne d'eau  
4 unités

Water line cleaner  
magic sponges  
4 units

Spugne magiche per la  
linea di galleggiamento  
4 unità

REF. PGL4

DIS pack 12



8 4 1 2 0 8 1 2 6 4 4 3 1



protection hiver

protezione per l'inverno

**PROTECCIÓN INVIERNO WINTER PROTECTION**  
**PROTECTION HIVER PROTEZIONE PER L'INVERNO**



Flotador de hibernaje  
Flotteur d'hivernage

Winterising float  
Galleggiante inverno

REF. 40580

BX PACK 10



Gizmo - protección del skimmer  
Gizmo - protection du skimmer

Gizmo - skimmer protection  
Gizmo - protezione per skimmer

REF. 40581

BX PACK 12



Tapón de invernaje 1,5"  
Bouchon d'hivernage 1,5"

Winterising plug 1,5"  
Tappo inverno 1.5"

REF. 40582

BX PACK 6



Tapón de invernaje 2"  
Bouchon d'hivernage 2"

Winterising plug 2"  
Tappo inverno 2"

REF. 40583

BX PACK 6



material de limpieza

cleaning material

**MANGUERAS VACUUM HOSES**  
**TUYAUX FLOTTANTS TUBI GALLEGGIANTI**

Manguera limpiafondos 15m  
con 2 terminales Ø38mm  
Tuyau pour nettoyeur de fond 15m  
avec 2 embouts soudés Ø38mm

Vacuum hose 15m  
with 2 cuffs Ø38mm  
Tubo puliscifondo 15m  
con 2 terminali da Ø38mm

REF. 40004

BX pack 1



Manguera limpiafondos 12m  
con 2 terminales Ø38mm  
Tuyau pour nettoyeur de fond 12m  
avec 2 embouts soudés Ø38mm

Vacuum hose 12m  
with 2 cuffs Ø38mm  
Tubo puliscifondo 12m  
con 2 terminali da Ø38mm

REF. 40003

BX pack 1



Manguera limpiafondos 10m  
con 2 terminales Ø38mm  
Tuyau pour nettoyeur de fond 10m  
avec 2 embouts soudés Ø38mm

Vacuum hose 10m  
with 2 cuffs Ø38mm  
Tubo puliscifondo 10m  
con 2 terminali da Ø38mm

REF. 40002

BX pack 1



Manguera limpiafondos 8m  
con 2 terminales Ø38mm  
Tuyau pour nettoyeur de fond 8m  
avec 2 embouts soudés Ø38mm

Vacuum hose 8m  
with 2 cuffs Ø38mm  
Tubo puliscifondo 8m  
con 2 terminali da Ø38mm

REF. 40001

BX pack 1



Manguera limpiafondos 6m  
con 2 terminales Ø38mm  
Tuyau pour nettoyeur de fond 6m  
avec 2 embouts soudés Ø38mm

Vacuum hose 6m  
with 2 cuffs Ø38mm  
Tubo puliscifondo 6m  
con 2 terminali da Ø38mm

REF. AR210

BX pack 1



# matériel de nettoyage materiale di pulizia



Manguera limpiafondos 4m  
con 2 terminales Ø38mm  
Tuyau pour nettoyeur de fond 4m  
avec 2 embouts soudés Ø38mm

Vacuum hose 4m  
with 2 cuffs Ø38mm  
Tubo puliscifondo 4m  
con 2 terminali da Ø38mm

REF. AR212

BXL pack 1



8 412081 240824



Manguera limpiafondos 12m  
con 2 terminales Ø32mm  
Tuyau pour nettoyeur de fond 12m  
avec 2 embouts soudés Ø32mm

Vacuum hose 12m  
with 2 cuffs Ø32mm  
Tubo puliscifondo 12m  
con 2 terminali da Ø32mm

REF. 770323

BXL pack 1



3 605217 703231



Manguera limpiafondos 7m  
con 2 terminales Ø32mm  
Tuyau pour nettoyeur de fond 7m  
avec 2 embouts soudés Ø32mm

Vacuum hose 7m  
with 2 cuffs Ø32mm  
Tubo puliscifondo 7m  
con 2 terminali da Ø32mm

REF. 770322

BXL pack 1



3 605217 703224



Enrollador de mangueras  
flotantes hasta 15m.  
(Manguera no incluida)

Vacuum hoses roller  
maximum 15m.  
(Vacuum hoses not included)

Enrouleur de tuyaux  
flottants. Jusqu'à 15m.  
(Tuyau non inclus)

Avvolgitore per tubo  
galleggiante fino a 15 m.  
(Tubo non incluso)

REF. 90165

CBX PACK 1



8 427370 901652



Terminal manguera flotante - Ø38mm  
Embout tuyau flottant - Ø38mm

Hose cuff - Ø38mm  
Raccordo per tubo Ø38 mm

REF. 40012

BX PACK 20



8 427370 400124



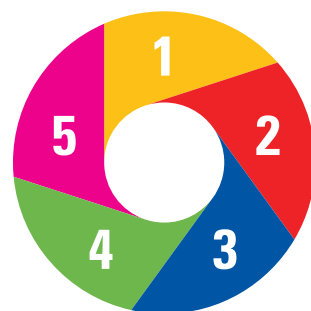

producto químico chemicals  
produits d'entretien prodotti chimici



**MADE  
IN  
EU**

**PASOS PARA CUIDAR DE SU PISCINA STEPS TO TAKE CARE OF YOUR SWIMMING POOL**  
**ÉTAPES À SUIVRE POUR PRENDRE SOIN DE VOTRE PISCINE INDICAZIONI PER IL TRATTAMENTO DELLA PISCINA**



Regular el pH  
 pH regulation  
 Réguler le pH  
 Correttori di pH

Higienizar el agua  
 Water sanitizing  
 Higiéniser l'eau  
 Igienizzazione dell'acqua

**1**

**2**

**3a 3b 3c**

¿Cómo?  
**How?**  
 ¿Comment?  
 ¿Come?

Minorador de pH  
 pH reduce  
 Baisse le pH  
 Riduttore di pH

Incrementador de PH  
 pH increase  
 Augmente le pH  
 Incrementatore pH

Cloro choque  
 Shock chlorine  
 Chlore choc  
 Cloro shock

Cloro lento  
 Slow chloration  
 Chlore lent  
 Cloro lento

Bromo  
 Bromine  
 Brome  
 Bromine

Oxígeno activo  
 Active oxygen  
 Oxygène actif  
 Ossigeno attivo

¿Para qué?  
**Why?**  
 ¿Pourquoi?  
 ¿Perché?

Obtener un pH entre 7,2 y 7,6  
 To have a pH value between 7,2 and 7,6

Obtenir un pH entre 7,2 et 7,6

Stabilizzare pH tra 7.2 e 7.6

Higienizar rápidamente y destruir los organismos, hongos y bacterias  
 To sanitize quickly and to eliminate all the organisms and bacteria

Higiéniser rapidement et détruire les organismes, champignons et bactéries

igienizzare rapidamente e distruggere tutti gli organismi, funghi e batteri

Desinfectar permanentemente  
 To have a permanent disinfection

Désinfecter en permanence

Disinfezione permanente

¿Cuándo?  
**When?**  
 ¿Quando?  
 ¿Quando?

A diario  
 Daily  
 Chaque jour  
 Trattamento quotidiano

Al inicio de temporada / Después de condiciones climáticas extremas / Uso intensivo de la piscina  
 At the beginning of the swim season / After bad weather conditions / High use level

Début de saison / Après des conditions climatiques extrêmes / Usage intensif de la piscine

Inizio stagione / Dopo che si sono verificate cambiamenti climatici molto forti / Uso intensivo della piscina

A diario  
 Daily  
 Chaque jour  
 Trattamento quotidiano

Resultado  
**Result**  
 Résultat  
 Risultato

pH ideal para la piel y los ojos. Instalaciones en perfecto estado  
 Ideal pH for skin and eyes. Good conditions equipment

pH idéal pour la peau et les yeux. Installations en parfait état

pH stabile non genera fastidi ad occhi e alla pelle

Agua limpia y libre de posibles contagios  
 Clean water without contagious risk

Eau propre et libre de possibles contagions

Acqua pulita e libera da ogni impurità

Agua limpia y libre de posibles contagios  
 Clean water without contagious risk

Eau propre et libre de possibles contagions

Acqua pulita e libera da ogni impurità





Tratamiento antialgas  
Anti-algae treatment  
Traitement anti-algues  
Trattamento antialghe

Floculación  
Flocculation  
Floculation  
Floculante

Complet 4  
Actions

Total 5 Actions

Total 10 Actions

4

5

Antialgas concentrado  
Concentrated algaecide  
Anti-algues concentré  
Antialghe concentrato

Antialgas Extra  
Extra anti-algae  
Anti-algues Extra  
Antialghe extra

Floculante  
Flocculant  
Floculant  
Floculante

Fórmula innovadora que permite en una sola aplicación, eliminar bacterias, virus y microorganismos en general

Thanks to its new formula, you can eliminate bacteria, virus and microorganisms

Formule innovatrice, il permet avec une seule application, d'éliminer bactéries, virus et microorganismes en général

Formula innovativa che permette in una sola applicazione eliminare i batteri, virus e microorganismi in generale

Prevenir la aparición de algas  
To avoid algae apparition  
Prevenir l'apparition des algues  
Prevenire la comparsa delle alghe

Eliminar las algas existentes  
To eliminate the algae  
Éliminer les algues existantes  
Eliminare la presenza di alghe

Eliminar las partículas en suspensión  
To eliminate particles in suspension  
Éliminer les particules en suspension  
Elimina le impurità

**4 funciones:**  
- Cloro  
- Antialgas  
- Estabilizante  
- Floculante

**4 functions:**  
- Chlorine  
- Antialgae  
- Stabiliser  
- Flocculant

**4 fonctions:**  
- Chlore  
- Anti-algues  
- Stabilisant  
- Floculant

**4 funzioni:**  
- Cloro  
- Antialghe  
- Stabilizzante  
- Floculante

**5 funciones:**  
- Cloro  
- Antialgas  
- Estabilizante  
- Floculante  
**Anticalcáreo**

**5 functions:**  
- Chlorine  
- Antialgae  
- Stabiliser  
- Flocculant  
**- Antilime**

**5 fonctions:**  
- Chlore  
- Anti-algues  
- Stabilisant  
- Floculant  
**- Anticalcaire**

**5 funzioni:**  
- Cloro  
- Antialghe  
- Stabilizzante  
- Floculante  
**- Anticalcare**

**10 funciones:**  
- Bactericida - Regulador de pH  
- Floculante - Estabilizante de cloro  
- Coagulante - Anticalcáreo  
- Algicida - Viricida  
- Algistático - Fungicida

**10 functions:**  
- Germicide - pH regulator  
- Flocculent - Chlorine stabilizer  
- Coagulant - Anti-Limescale Agent  
- Algicide - Virucide  
- Algistatic - Fungicide

**10 fonctions:**  
- Bactéricide - Régulateur de pH  
- Floculant - Stabilisant de chlore  
- Coagulant - Anticalcaire  
- Algicide - Virucide  
- Algistatique - Fongicide

**10 funzioni:**  
- Battericida - Regolatore de pH  
- Floculante - Stabilizzante del cloro  
- Coagulante - Anticalcare  
- Alghicida - Virucida  
- Alghistatico - Funghicida

Según convenga  
Depending on water quality  
Selon convenance  
Quando necessario

Semanalmente  
Weekly  
Chaque semaine  
Settimanalmente

Agua sin algas  
Water without algae

Agua cristalina  
Crystalline water

**New! • ¡Novedad!**  
 New single-dose format more comfortable  
 Nuevo formato en monodosis más cómodo



**MINORADOR DE pH pH REDUCE**  
**BAISSE LE pH RIDUTTORE pH**

**pH MINUS**

MONODOSIS SINGLE-DOSE ECODOSES MONODOSI

Ref. **PPHME** 650 g DIS 5 412081 303055

Ref. **PPHM** 650 g DIS 5 412081 302966



**INCREMENTADOR DE pH pH INCREASE**  
**AUGMENTE LE pH INCREMENTATORE pH**

**pH PLUS**

MONODOSIS SINGLE-DOSE ECODOSES MONODOSI

Ref. **PPHPE** 750 g DIS 5 412081 303048

Ref. **PPHP** 750 g DIS 5 412081 302959



**CLORO CHOQUE SHOCK CHLORINE**  
**CHLORE CHOC CLORO SHOCK**

**CLORCHOC**

MONODOSIS SINGLE-DOSE ECODOSES MONODOSI

Ref. **PCLSCHE** 300 g DIS 5 412081 303062

Ref. **PCLSCH** 300 g DIS 5 412081 302973



**COMPLET 4 ACCIONES COMPLET 4 ACTIONS**  
**COMPLET 4 ACTIONS COMPLET 4 AZIONI**

**CHLORE 4 ACTIONS**

MONODOSIS SINGLE-DOSE ECODOSES MONODOSI

Ref. **PCLMULE** 5x250 g DIS 6 412081 303079

Ref. **PCLMUL** 5x250 g DIS 6 412081 302980

**Nouveauté! • Nuovo!**

Nouveau format en écodoses très facile à utiliser  
Nuovo formato monodosi più confortevole



**ANTIALGAS ANTI ALGAE**  
**ANTI-ALGUES ANTIALGHE**

**ANTI - ALGUES**

MONODOSIS SINGLE-DOSE ECODOSES MONODOSI

Ref. **PALGE** 8x20 g DIS 6 412081 303086

Ref. **PALG** 8x20 g DIS 6 412081 302997



**FLOCULANTE FLOCCULANT**  
**FLOCCULANT FLOCCULANTE**

**FLOCCULANT**

MONODOSIS SINGLE-DOSE ECODOSES MONODOSI

Ref. **PNATCLE** 4x30 g DIS 8 412081 303093

Ref. **PNATCL** 4x30 g DIS 8 412081 303000



Antialgas + Floculante + Antical + Agua libre de aceites y espuma  
Antialgae + Floculant + Anti lime + Water free of oils and foam  
Anti-algues + Floculant + Anti-calcaire + Eau sans huile ni mousse  
Antialghe + Floculante + Anticalcare + Acqua priva di oli e schiuma

**MULTIPROTECT**

MONODOSIS SINGLE-DOSE ECODOSES MONODOSI

Ref. **PCPMPE** 8x35 g DIS 5 412081 303109

Ref. **PCPMP** 8x35 g DIS 5 412081 303017

Filtro de cartucho Cartridge filter Epurateur à cartouche Filtri a cartuccia

Ref. **PCPMPCE** 8x35 g DIS 5 412081 303116

Ref. **PCPMPC** 8x35 g DIS 5 412081 303024



**INVERNADOR WINTERISER**  
**HIVERNAGE TRATTAMENTO PER L'INVERNO**

**COMPLET 4 ACTIONS**

MONODOSIS SINGLE-DOSE ECODOSES MONODOSI

Ref. **PWINTCE** 350 g DIS 6 412081 303123

Ref. **PWINTC** 350 g DIS 6 412081 303031



**PRODUCTO QUÍMICO SIN BÓRICO BORIC FREE CHEMICALS**  
**PRODUIT CHIMIQUE SANS BORIQUE PRODOTTO CHIMICO SENZA BORICO**



*smartcare*  
**tecnology**

 **BORIC ACID FREE**       **LONG LASTING**       **CLEANER**

**Producto más sano.** Nuestro aditivo no es en ningún caso perjudicial para la salud.

**Healthier product.** Our additive is not harmful to health in any way.

**Produit plus sain.** Notre additif n'est pas nocif pour la santé.

**Prodotto più sano.** Il nostro additivo non è dannoso per la salute in alcun modo.

**Más eficaz.** Permite una disolución más lenta y homogénea de la pastilla.

**More effective.** It allows a slower and more homogeneous dissolution of the tablet.

**Plus efficace.** Cela permet une dissolution plus lente et plus homogène du comprimé.

**Più efficace.** Permette una dissoluzione più lenta e omogenea della compressa.

**Más limpio.** No deja ningún residuo: reduce el consumo de otros químicos y el de agua por limpiezas del filtro.

**Cleaner.** It does not leave any residue: it reduces the consumption of other chemicals and water.

**Plus propre.** Il ne laisse aucun résidu: il réduit la consommation d'autres produits chimiques et celle d'eau par le nettoyage du filtre.

**Cleaner.** Non lascia alcun residuo: riduce il consumo di altri prodotti chimici e quello dell'acqua mediante pulizia del filtro.



**CLORO LENTO TRICHLORINE  
CHLORE LENT CLORO LENTO**

Para conseguir una higienización preventiva y continua del agua, es necesario mantener una tasa de cloración libre. Por ello, conviene efectuar una cloración permanente o "cloración lenta".





To have a preventive and continue sanitizing, it is necessary to keep a free chloration value. For this reason, people must do a permanent chloration or a "slow chloration".

Pour avoir une hygiénisation préventive et continue, il est nécessaire de maintenir un taux de chloration libre. Pour cette raison, il faut effectuer une chloration permanente ou «chloration lente».

Per ottenere una igienizzazione preventiva e continua dell'acqua, è necessario mantenere un valore di cloro "libero". Per questo è bene effettuare una clorazione continua o una "clorazione lenta".

**CLORLENT**

TABLETAS 250g 250g TABLETS GALETS 250g PASTIGLIE 250g

	Ref. <b>76087</b>	1,5 Kg	pack 20	
	Ref. <b>76086</b>	4 Kg	pack 4	



**COMPLET 4 ACCIONES COMPLET 4 ACTIONS  
COMPLET 4 ACTIONS COMPLET 4 AZIONI**

Cloro + Antialgas + Estabilizante + Floculante  
Chlorine + Antialgae + Stabiliser + Flocculant  
Chlore + Anti-algues + Stabilisant + Flocculant  
Cloro + Antialghe + Stabilizzante + Floculante

**COMPLET 4 ACTIONS**

TABLETAS 250g 250g TABLETS GALETS 250g PASTIGLIE 250g





	Ref. <b>76090</b>	1,5 Kg	pack 20	
	Ref. <b>76088</b>	4 Kg	pack 4	
	Ref. <b>76089</b>	4 Kg	pack 60	

**TOTAL 5 ACCIONES TOTAL 5 ACTIONS  
TOTAL 5 ACTIONS TOTAL 5 AZIONI**

Cloro + Antialgas + Estabilizante + Floculante + Antical  
Chlorine + Antialgae + Stabiliser + Flocculant + Anti lime  
Chlore + Anti-algues + Stabilisant + Flocculant + Anti-calcaire  
Cloro + Antialghe + Stabilizzante + Floculante + Anticalcare

**TOTAL 5 ACTIONS**

TABLETAS 250g 250g TABLETS GALETS 250g PASTIGLIE 250g

	Ref. <b>76092</b>	1,5 Kg	pack 20	
	Ref. <b>76091</b>	4 Kg	pack 4	

## Cálculo de volumen de agua

Para un correcto suministro del producto químico, es importante calcular el volumen de agua de la piscina.

## Calculate the pool water volume

It is important to calculate the pool water volume to do a correct chemical treatment.

## Calcul de volume d'eau

Pour un bon dosage du produit chimique, il est nécessaire de calculer le volume d'eau de la piscine.

## Calcolo del volume d'acqua

Per un corretto dosaggio del prodotto chimico è importante calcolare il volume d'acqua di una piscina.

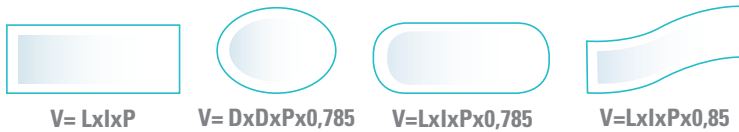

<b>V</b>	Volumen en m <sup>3</sup>	Volume in m <sup>3</sup>	Volume en m <sup>3</sup>	Volume in m <sup>3</sup>
<b>L</b>	Longitud en m	Length in m	Longueur en m	Lunghezza in m
<b>I</b>	Anchura en m	Width in m	Largeur en m	Larghezza in m
<b>D</b>	Diámetro en m	Diameter in m	Diamètre en m	Diametro in m
<b>P</b>	Profundidad en m	Depth in m	Profondeur en m	Profondità media in m

### Ejemplo Example Exemple Esempio

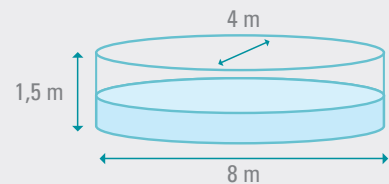

$$1,5 \text{ m} \times 8 \times 4 \times 0,785 = 37,68 \text{ m}^3$$

## LEYENDA LEGEND LÉGENDE LEGENDA

	500 g				1 L
	1 Kg		10 Kg		
	1 Kg / 1,5 Kg		1 L		1 kg
	3 kg		3 L		1 L / 0,5 L
	5 Kg		5 L		1/2 BOX PALET
	5 Kg		10/20 L		

**REGULADORES DE PH PH REGULATORS**  
**RÉGULATEURS DE PH CORRETTORI DI PH**

- El pH indica la acidez o la basicidad del agua. En una piscina debe mantenerse ajustado entre los valores 7.2 y 7.6, ya que además de conservar las instalaciones en óptimas condiciones, es el ideal para la piel y los ojos de los bañistas.
- pH shows if water is acid or basic. Pool water pH must be between 7.2 and 7.6, because it helps to conserve the equipment in good conditions and it is ideal for swimmer eyes and skin.
- Le pH indique l'acidité ou la basicité de l'eau. L'eau de la piscine doit se maintenir entre les taux 7.2 et 7.6, car il aide à mieux conserver les installations et est l' idéal pour la peau et les yeux des baigneurs.
- Il pH indica la acidità e la basicità dell' acqua. In una piscina il valore di riferimento deve essere sempre tra 7.2 e 7.6, dal momento che, oltre a favorire il trattamento chimico che viene effettuato, è il valore ideale affinché la pelle e gli occhi dei bagnanti non si irritino.

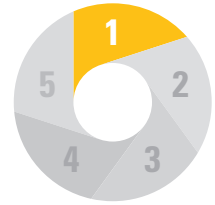



**INCREMENTADOR DE pH pH INCREASE**  
**AUGMENTE LE pH INCREMENTATORE pH**

**pH PLUS**

GRANULADO GRANULES GRANULÉS GRANULATO

 Ref. **76018** 1 Kg pack 20 

 Ref. **76001** 5 Kg pack 4 



Incrementador de pH: para aumentar y estabilizar el pH  
pH increase: to increase and stabilize pH  
Augmente le pH: pour augmenter et stabiliser le pH  
Per aumentare e stabilizzare il pH

**MINORADOR DE pH pH REDUCE**  
**BAISSE LE pH RIDUTTORE pH**

**pH MINUS**

GRANULADO GRANULES GRANULÉS GRANULATO

 Ref. **76019** 1,5 Kg pack 20 

 Ref. **76002** 5 Kg pack 4 

  Ref. **76083** 20 l pack 1  
Minorador de pH: para bajar y estabilizar el pH  
pH reduce: to lower and stabilize pH  
Baisse le pH: pour baisser et stabiliser le pH  
Per abbassare e stabilizzare il pH

7.2

7.6



use pH+

use pH-

# producto químico chemicals



## CLORO CHOQUE SHOCK CHLORINE CHLORE CHOC CLORO SHOCK

El Cloro Choque permite destruir rápida y eficazmente todos los organismos, hongos y bacterias. Conviene realizar una cloración de choque: Al inicio de la temporada de baño / Después de condiciones climáticas extremas / En caso de uso intensivo de la piscina.

It eliminates quickly all the organisms and bacteria. It is necessary to do a Shock chlorination: At the beginning of the swim season / After bad weather conditions / High use level.

Le Chlore Choc permet de détruire rapidement tous les organismes, champignons et bactéries. Il convient d'effectuer une chloration choc: Au début de la saison de baignade / Après des conditions climatiques extrêmes / En cas d'usage intensif de la piscine.

Permette di eliminare rapidamente ed efficacemente tutti gli organismi, funghi e batteri. E' utile usare questo tipo di prodotto: All'inizio della stagione / Dopo condizioni climatiche estreme / In caso di un uso intensivo della piscina.

### CLORCHOC

PASTILLAS 20g 20g TABLETS PASTILLES 20g PASTIGLIE 20g

 Ref. **76020** 1 Kg pack 20 

 Ref. **76070** 3 Kg pack 4 



 Ref. **76003** 5 Kg pack 4 



Con un 50% de cloro activo mínimo (tricloro). Disolución instantánea.  
Minimum 50% active chlorine (trichlorine). Instant dissolution.  
50% chlore actif minimum (trichlore). Dissolution instantanée.  
Con un minimo del 50% di cloro attivo (tricloro). Dissoluzione istantanea.

 Referencias para España

PASTILLAS 20g 20g TABLETS PASTILLES 20g PASTIGLIE 20g

 Ref. **76074** 1 Kg pack 20 

 Ref. **76075** 3 Kg pack 4 

 Ref. **76076** 5 Kg pack 4 

Con un 50% de cloro activo mínimo (tricloro). Disolución instantánea.  
Minimum 50% active chlorine (trichlorine). Instant dissolution.  
50% chlore actif minimum (trichlore). Dissolution instantanée.  
Con un minimo del 50% di cloro attivo (tricloro). Dissoluzione istantanea.

 Références pour la France · Referências para Portugal · Referenze per l'Italia



### CLORCHOC

GRANULADO GRANULES GRANULÉS GRANULATO

 Ref. **76021** 1 Kg pack 20 

 Ref. **76062** 1 Kg pack 200 

 Ref. **76069** 3 Kg pack 4 

 Ref. **76004** 5 Kg pack 4 

 Ref. **76064** 5 Kg pack 60 

Con un 55% de cloro activo mínimo. Disolución rápida.

Minimum 55% active chlorine. Quick dissolution.

55% chlore actif minimum. Dissolution rapide.

Con un 55% di cloro minimo attivo. Dissoluzione rapida.



## CLORO LENTO TRICHLORINE CHLORE LENT CLORO LENTO

Para conseguir una higienización preventiva y continua del agua, es necesario mantener una tasa de cloración libre. Por ello, conviene efectuar una cloración permanente o "cloración lenta".

To have a preventive and continue sanitizing, it is necessary to keep a free chloration value. For this reason, people must do a permanent chloration or a "slow chloration".



Pour avoir une hygiénisation préventive et continue, il est nécessaire de maintenir un taux de chloration libre. Pour cette raison, il faut effectuer une chloration permanente ou «chloration lente».

Per ottenere una igienizzazione preventiva e continua dell'acqua, è necessario mantenere un valore di cloro "libero". Per questo è bene effettuare una clorazione continua o una "clorazione lenta".

### CLORLENT

TABLETAS 250g 250g TABLETS GALETS 250g PASTIGLIE 250g

 Ref. **76022** 1 Kg pack 20 

 Ref. **76005** 5 Kg pack 4 

GRANULADO GRANULES GRANULÉS GRANULATO

 Ref. **76023** 1 Kg pack 20 



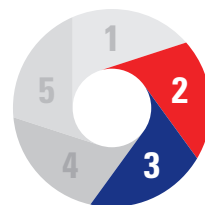

## BROMO BROMINE BROME BROMO

Diferencias respecto al cloro: menos olor, no daña la piel ni el cabello.  
Más eficacia en las aguas calientes y/o calcáreas.

Differences compared to chlorine: less smell, does not dry out skin and hair. More efficient in hot and/or calcareous water.

Différences par rapport au chlore: moins d'odeur, ne dessèche pas la peau ni les cheveux. Plus efficace dans les eaux chaudes et/ou calcaires.

Differenze rispetto al cloro: meno odore, non danneggia la pelle né i capelli. Più efficace con l'acqua molto calda e/o calcarea.

### BROM'LENT

PASTILLAS 20g 20g TABLETS PASTILLES 20g PASTIGLIE 20g

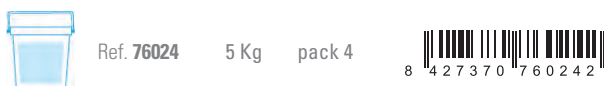

### BROM CHOC

GRANULADO GRANULES GRANULÉS GRANULATO



### BROM MULTI-ACTIONS

PASTILLAS 20g 20g TABLETS PASTILLES 20g PASTIGLIE 20g



Bromo multi-Acciones  
Bromine multi-Actions  
Brome multi-Actions  
Bromo multi funzioni



## OXÍGENO ACTIVO ACTIVE OXYGEN OXYGÈNE ACTIF OSSIGENO ATTIVO

Ofrece muchas ventajas, ya que proporciona una desinfección muy eficaz y a diferencia del cloro, no provoca irritaciones oculares ni desprende olores desagradables. Producto que necesita de un dosificador.

This product offers a lot of advantages. It disinfects pool water and contrary to chlorine, it does not cause eye irritation neither and bad smells. This product needs a dispenser.

Ce produit offre beaucoup d'avantages par rapport au chlore, car il ne provoque aucune irritation oculaire, ôte les mauvaises odeurs et en même temps fait une désinfection très efficace. Il a besoin d'un doseur.

Offre molti vantaggi, dal momento che sviluppa una igienizzazione molto efficace e, a differenza del cloro, non irrita gli occhi e non ha un odore sgradevole. E' un prodotto che necessita del dosatore.

### ACTI OXY

LÍQUIDO LIQUID LIQUIDE LIQUIDO



**Multifunciones Multiactions**  
**Multi-actions Multi funzioni**

Se trata de un producto revolucionario, ya que gracias a su fórmula innovadora permite en una sola aplicación, eliminar las bacterias, virus y microorganismos en general, evitar el desarrollo de algas, al mismo tiempo que mantiene transparente y cristalina el agua.  
Revolution product: Thanks to its new formula, allows in a single application eliminate bacteria, virus and micro organisms, avoid algae and have clear and crystalline water.



**COMPLET 4 ACCIONES COMPLET 4 ACTIONS**  
**COMPLET 4 ACTIONS COMPLET 4 AZIONI**

Cloro + Antialgas + Estabilizante + Floculante  
Chlorine + Antialgae + Stabiliser + Flocculant  
Chlore + Anti-algues + Stabilisant + Flocculant  
Cloro + Antialghe + Stabilizzante + Flocculante



**COMPLET 4 ACTIONS**



TABLETAS 250g 250g TABLETS GALETS 250g PASTIGLIE 250g



 Ref. **76007** 1 Kg pack 20  8 427370 760075

 Ref. **76063** 1 Kg pack 200  8 427370 760631

 Ref. **76067** 3 Kg pack 4  8 427370 760679

 Ref. **76006** 5 Kg pack 4  8 427370 760068

 Ref. **76055** 5 Kg pack 60  8 427370 760556

 Ref. **76031** 10 Kg pack 2  8 427370 760310

PASTILLAS 20g 20g TABLETS PASTILLES 20g PASTIGLIE 20g

 Ref. **76032** 1 Kg pack 20  8 427370 760327

 Ref. **76033** 5 Kg pack 4  8 427370 760334

GRANULADO GRANULES GRANULÉS GRANULATO

 Ref. **76034** 5 Kg pack 4  8 427370 760341

50 BLOQUES 500g 500g 50 BLOCKS 50 BLOCS 500g 50 PASTIGLI 500g

  Ref. **76084** 25Kg pack 50  8 427370 760846

Il s'agit d'un produit révolutionnaire. Grâce à sa formule innovatrice, il permet avec une seule application, d'éliminer les bactéries, virus et micro organismes en général, d'éviter l'apparition d'algues, ainsi que de conserver l'eau transparente et cristalline.

Si tratta di un prodotto rivoluzionario proprio perché, grazie alla sua formula innovatrice, permette, in una sola applicazione, di eliminare i batteri, virus e tutti i microrganismi evitando il proliferare di alghe, mantenendo allo stesso tempo l'acqua trasparente e cristallina.



**COMPLET 4 ACTIONS- SPECIAL LINER**

TABLETAS 250g 250g TABLETS GALETS 250g PASTIGLIE 250g

 Ref. **76039** 1 Kg pack 20  8 427370 760396

 Ref. **76012** 5 Kg pack 4  8 427370 760129

Sin sulfato de cobre  
Without copper sulphate.  
Sans sulfate de cuivre  
Senza solfato di rame

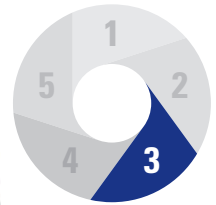

**BOYA MULTIFUNCIÓN  
MULTIACTION FLOAT  
BOUÉE MULTI-ACTION  
TRATTAMENTO GALLEGGIANTE MULTI  
FUNZIONE**

**HIVER FLOAT**

PASTILLAS TABLETS PASTILLES PASTIGLIE



Ref. **76085**

1,75 Kg

pack 8



**TOTAL 5 ACCIONES TOTAL 5 ACTIONS  
TOTAL 5 ACTIONS TOTAL 5 AZIONI**

Cloro + Antialgas + Estabilizante + Floculante + Antical  
Chlorine + Antialgae + Stabiliser + Flocculant + Anti lime  
Chlore + Anti-algues + Stabilisant + Floculant + Anti-calcaire  
Cloro + Antialghe + Stabilizzante + Flocculante + Anticalcare

**TOTAL 5 ACTIONS**

TABLETAS 250g 250g TABLETS GALETS 250g PASTIGLIE 250g



Ref. **76082**

1 Kg

pack 20



Ref. **76068**

3 Kg

pack 4



Ref. **76036**

5 Kg

pack 4



Ref. **76037**

10 Kg

pack 2



**MULTIFUNCIÓN MONODOSES  
MONODOSE MULTI-ACTIONS  
MULTI-ACTIONS MONODOSE  
MULTI FUNZIONI MONODOSI**



Cloro + Antialgas + Estabilizante + Floculante  
Chlorine + Antialgae + Stabiliser + Flocculant  
Chlore + Anti-algues + Stabilisant + Floculant  
Cloro + Antialghe + Stabilizzante + Flocculante

**MULTIACTIONS**

TABLETAS 250g 250g TABLETS GALETS 250g PASTIGLIE 250g



Ref. **76058**

4 Kg

pack 16



16 dosis de 250g. Fácil de usar, dosis exacta. Para piscinas hasta 60m<sup>3</sup>  
250gr 16 dose. Easy to use, accurate dose. Pools up to 60m<sup>3</sup>.

16 doses de 250g. Facile à utiliser, dose précise. Pour piscines de jusqu'à 60m<sup>3</sup>.  
16 dosi da 250 grammi. Semplice da utilizzare: eroga sempre la dose corretta. Per piscine fino a 60 m<sup>3</sup>

**TOTAL 10 ACCIONES TOTAL 10 ACTIONS  
TOTAL 10 ACTIONS TOTAL 10 AZIONI**

Desinfectante + Bactericida + Floculante + Coagulante +  
Algicida + Algistático + Regulador de pH + Estabilizante  
de cloro + Anticalcáreo + Virucida + Fungicida  
Disinfectant+ Germicide + Flocculent + Coagulant +  
Algicide + Algistatic + pH regulator + Chlorine stabilizer +  
Anti-Limescale Agent + Virucide+ Fungicide  
Désinfectant + Bactéricide + Flocculant + Coagulant +  
Algicide + Algistatique + Régulateur de pH + Stabilisant  
de chlore + Anticalcaire + Virucide + Fongicide  
Disinfettante + Battericida + Flocculante + Coagulante +  
Alghicida + Alghistatico + Regolatore del pH + Stabilizzante  
del cloro + Anticalcare + Virucida + Funghicida

**TOTAL 10 ACTIONS**

TABLETAS 250g 250g TABLETS GALETS 250g PASTIGLIE 250g



Ref. **76065**

1 Kg

pack 20



Ref. **76038**

5 Kg

pack 4



## Tratamiento antialgas **Anti-algae treatment** Traitement anti-algues **Trattamento antialghe**





### ANTIALGAS EXTRA EXTRA ANTI ALGAE ANTI-ALGUES EXTRA ANTIALGHE EXTRA

#### ANTIALG XTRA

LÍQUIDO LIQUID LIQUIDE LIQUIDO

 Ref. **76041** 1 L pack 12 

 Ref. **76072** 3 L pack 6 

 Ref. **76042** 5 L pack 4 



3 acciones. Extra: para eliminar todas las algas.  
 3 actions. Extra: to eliminate the algae.  
 3 actions. Extra: pour éliminer la totalité des algues.  
 3 azioni. Extra. Per eliminare tutti i tipi di alghe.

#### ANTIALG

LÍQUIDO LIQUID LIQUIDE LIQUIDO

 Ref. **76009** 1 L pack 12 

 Ref. **76071** 3 L pack 6 

 Ref. **76008** 5 L pack 4 

 Ref. **76056** 5 L pack 48 

Para prevenir la aparición de algas.  
 To prevent the appearance of algae  
 Pour prévenir l'apparition d'algues.  
 Per prevenire la comparsa delle alghe.



Las algas son organismos vegetales unicelulares que pueden desarrollarse y multiplicarse rápidamente en el agua, sobre todo cuando su temperatura es templada.

Algae are vegetal unicellular organisms that can quickly develop and multiply themselves in the water, specially when the temperature of the water is warm.

Les algues sont des organismes végétaux unicellulaires qui peuvent apparaître et se multiplier très rapidement dans l'eau, surtout quand la température de l'eau est tempérée.

Le alghe sono organismi vegetali unicellulari che possono svilupparsi e moltiplicarsi soprattutto quando la temperatura dell'acqua è abbastanza calda.



### ANTIALGAS CONCENTRADO CONCENTRATED ANTI ALGAE ANTI-ALGUES CONCENTRÉ ANTIALGHE CONCENTRATO

#### ANTIALG COMPACT XTRA



LÍQUIDO LIQUID LIQUIDE LIQUIDO

 Ref. **76013** 1 L pack 12 

 Ref. **76014** 0,5 L pack 24 

#### ANTIALG COMPACT

LÍQUIDO LIQUID LIQUIDE LIQUIDO

 Ref. **76015** 1 L pack 12 

 Ref. **76016** 0,5 L pack 24 

**Floculante Flocculant**  
**Floculant Flocculante**

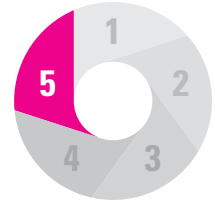

La floculación permite obtener un agua cristalina. Existen dos tipos de floculación: la que se realiza dentro del filtro y la floculación dentro del vaso. La primera permite aumentar la fineza de filtración y eliminar de esta manera las partículas más finas. Ésta se efectúa gracias a los cartuchos floculantes (incompatibles con filtros de cartucho) colocados en el cesto del skimmer. La segunda permite agrupar entre ellas las impurezas que no pueden ser filtradas individualmente y que son el origen de un agua turbia. Esta operación se efectúa con el floculante líquido.

Flocculation allows to obtain a crystalline water. There are two kind of flocculation: inside the filter and in the pool. With the first one we increase the fineness of filtration in order to eliminate smaller particles. For this process we introduce flocculants cartridges (incompatible with cartridge filters) in the skimmer basket. The second one helps us to group all the impurities that are the beginning of brown water thanks to liquid flocculant.

La floculation permet d'obtenir une eau cristalline. Il y a deux types de floculation: celle qui se fait dans le filtre et la floculation dans le bassin. La première permet d'augmenter la finesse de filtration et d'éliminer de cette façon les particules plus fines. S'effectue grâce aux cartouches floculantes (incompatibles avec les filtres à cartouche) dans le panier du skimmer. La deuxième permet de regrouper entre elles les impuretés qui ne peuvent pas être filtrées et qui sont l'origine des eaux troubles. Cette opération se fait avec le floculant liquide.

La flocculazione permette di ottenere un'acqua cristallina. Esistono due tipi di flocculazione: quella che si realizza all'interno del filtro e quella diluendo il prodotto in un contenitore. La prima permette di migliorare la filtrazione ed eliminare le particelle più fini e si effettua grazie alle cartucce floculanti (incompatibili con i filtri a cartuccia) poste dentro il cesto dello skimmer. La seconda permette di raggruppare tra loro le impurità che non possono essere filtrate individualmente e che sono la causa dell'acqua torbida. Questo procedimento si effettua con il floculante liquido.



CARTUCHOS 125g 125g CARTRIDGES CARTOUCHES 125g CARTUCCIA 125g

Ref. 76044 1 Kg pack 14 

Para mejorar la calidad de filtración (filtros de arena únicamente).  
Producto de mantenimiento.  
To increase filtration quality (sand filters only).  
Product Maintenance.  
Pour améliorer la qualité de filtration (filtres à sable uniquement).  
Produit de maintenance.  
Per migliorare la qualità della filtrazione (solo per filtri a sabbia).  
Prodotto di mantenimento.

**FLOCULANTE LÍQUIDO LIQUID FLOCCULANT**  
**FLOCULANT LIQUIDE FLOCCULANTE LIQUIDO**

**FLOCULANT**

LÍQUIDO LIQUID LIQUIDE LIQUIDO

 Ref. 76011 1 L pack 12 

 Ref. 76073 3 L pack 6 

 Ref. 76010 5 L pack 4 

Para clarificar el agua y eliminar las materias en suspensión.  
Recupera el agua turbia.  
To clarify water and eliminate substances in suspension.  
Retrieve the cloudy water.  
Pour clarifier l'eau et éliminer les matières en suspension.  
Récupère l'eau trouble.  
Rende acqua cristallina ed elimina le particelle in superficie.  
Recupera l'acqua torbida.

**PRODUCTOS COMPLEMENTARIOS COMPLEMENTARY PRODUCTS**  
**PRODUITS COMPLÉMENTAIRES PRODOTTI COMPLEMENTARI**



**DESINCRUSTANTE DE SUPERFICIE**  
**SURFACE DESCALER**  
**DÉTARTRANT DE SURFACE**  
**PULITORE SUPERFI CI D'ACQUA**

**DETRATANT SURFACE**

LÍQUIDO LIQUID LIQUIDE LIQUIDO



Ref. **76046** 1 L pack 12 

Para eliminar incrustaciones de cal.  
 To eliminate lime scales.  
 Pour éliminer les incrustations calcaires.  
 Per evitare la incrostazione del calcare.

**LIMPIADOR DE BORDES**  
**WATERLINE CLEANER**  
**NETTOYANT LIGNE D'EAU**  
**PULITORE SUPERFICI D'ACQUA**

**NETTOYANT LIGNE D'EAU**

LÍQUIDO LIQUID LIQUIDE LIQUIDO



Ref. **76047** 1 L pack 12 

Para eliminar la suciedad de la línea de flotación.  
 To eliminate the dirt on the waterline.  
 Pour éliminer la saleté sur la ligne d'eau.  
 Per eliminare particelle in superficie.

**TAC PLUS**

GRANULADO GRANULES GRANULÉS GRANULATO



Ref. **76081** 5 Kg pack 4 

Incrementador de alcalinidad  
 Alkalinity increase  
 Augmente l'alcalinité  
 Elevatore di alcalinità

**ANTICALCÁREO ANTI LIME**  
**ANTI-CALCAIRE ANTICALCARE**

**ANTICALC**

LÍQUIDO LIQUID LIQUIDE LIQUIDO



Ref. **76049** 1 L pack 12 



Ref. **76048** 5 L pack 4 

Para evitar la formación de cal.  
 Secuestrante de metales (hierro, cobre...)  
 To prevent lime formation.  
 Metal Sequestering Agents (iron, copper...)  
 Pour éviter la formation de calcaire.  
 Séquestrant de métaux (fer, cuivre, etc.)  
 Evita la formazione del calcare.  
 Sequestrante di metalli (ferro, rame)

**PRODUCTO QUÍMICO PARA EL INVIERNO CHEMICAL PRODUCTS FOR WINTER**  
**PRODUITS CHIMIQUES POUR L'HIVER PRODOTTI CHIMICI PER L'INVERNO**

Le facilitará la puesta en marcha de la piscina después del invierno, evitando la formación de algas y de cal.  
 Realizar el proceso cuando la temperatura del agua de la piscina sea inferior a 15°C.

- 1) Limpiar la piscina.
- 2) Ajustar el pH entre 7,2 - 7,6
- 3) Realizar una cloración de choque
- 4) Dejar en funcionamiento el fi ltrro hasta el día siguiente 5) Realizar una limpieza del fi ltrro
- 6) Añadir el invernador

It makes easier for you the start-up of the pool after winter, avoiding algae and lime formation.

Please carry out the following if the temperature of the water drops below 15°C.

- 1) Clean the swimming pool
- 2) Set the pH balance between 7.2 – 7.6
- 3) Carry out a chlorine crash course
- 4) Leave the fi ltr running until the following day
- 5) Clean the fi ltr
- 6) Add the winterizing agent



**INVERNADOR WINTERISER**  
**HIVERNAGE TRATTAMENTO PER L'INVERNO**

**HIVERNAGE**

LÍQUIDO LIQUID LIQUIDE LIQUIDO



Ref. **76050** 1 L pack 12 



Ref. **76051** 5 L pack 4 

Vous facilite la mise en route de la piscine après l'hiver en évitant la formation d'algues et de calcaire.  
 Réaliser le processus lorsque la température de l'eau de la piscine est inférieure à 15°C.

- 1) Nettoyer la piscine
- 2) Ajuster le pH entre 7,2 - 7,6
- 3) Réaliser une chloration de choc
- 4) Laisser fonctionner le fi ltrro jusqu'au lendemain
- 5) Nettoyer le fi ltrro
- 6) Ajouter l'hivernant

Renderà più semplice l'inizio della nuova Stagione, dopo l'inverno, evitando la formazione di alghe e calcare.

Realizzare la procedura quando la temperatura dell'acqua della piscina è inferiore a 15°C.

- 1) Pulire la piscina
- 2) Regolare il pH tra 7,2 e 7,6
- 3) Eff ettuate una clorazione d'urto
- 4) Lasciare in funzione il fi ltrro fi no al giorno successivo
- 5) Eff ettuate una pulizia del fi ltrro
- 6) Aggiungere lo svernante



**INVERNADOR CONCENTRADO CONCENTRATED**  
**WINTERISER HIVERNAGE CONCENTRÉ**  
**TRATTAMENTO PER L'INVERNO CONCENTRATO**

**HIVERNAGE CONCENTRÉ**

LÍQUIDO LIQUID LIQUIDE LIQUIDO



Ref. **76017** 1 L pack 12 

**INVERNADOR CON BOYA MULTIFUNCIÓN**  
**MULTIACTION FLOAT WINTERISER**  
**BOUÉE HIVERNAGE MULTI-ACTION**  
**TRATTAMENTO PER L'INVERNO**  
**GALLEGGIANTE MULTI FUNZIONE**

**HIVER FLOAT**

PASTILLAS TABLETS PASTILLES PASTIGLIE



Ref. **76080** 1,75 Kg pack 8 

REF. 90175

DIS PACK 24



Repulsivo Anti Insectos a base de aceites esenciales 100% naturales. Dosis de 3 pastillas de 30g.

Répulsif Anti Insectes à base d'huiles essentielles 100% naturelles. Doseur de 3 pastilles de 30g.

Anti Insect repellent using 100% natural essential oils. 30 g 3 tablet dosifier.

Repellente anti-insetti a base di oli essenziali 100% naturali. Dosatore di 3 pastiglie da 30g.



REF. 90178

DIS PACK 12



Repulsivo Anti Insectos a base de aceites esenciales 100% naturales. Caja de 6 pastillas de 30g.

Répulsif Anti Insectes à base d'huiles essentielles 100% naturelles. Boîte carton de 6 pastilles de 30g.

Anti Insect repellent using 100% natural essential oils. 30g 6 tablet box.

Repellente anti-insetti a base di oli essenziali 100% naturali. Confezione di 6 pastiglie da 30g.



REF. 90147

DIS PACK 12



**Stop Aguas Verdes**

Recupera las aguas verdes gracias a una nueva generación de polimeros hidrosolubles. Caja de 6 pastillas de 20g.

**Stop Eaux Vertes**

Il récupère les eaux vertes grâce à une nouvelle génération de polymères hydrosolubles. Boîte carton de 6 pastilles de 20g.

**Stop Green Waters**

Get back the green waters of your pool thanks to a new generation of water soluble polymers. 20g 6 tablet box.

**Stop Acque Verdi**

Recupera le acque verdi grazie ad una nuova generazione di polimeri idrosolubili. Confezione di 6 pastiglie da 20g.





REF. 90143

DIS PACK 12



**Stop Aguas Turbias**

Recupera las aguas turbias, y consigue un agua limpia y cristalina. Caja de 6 pastillas de 30g.

**Stop Eaux Troubles**

Traite les eaux troubles, et rend l'eau propre et cristalline. Boite carton de 6 pastilles de 30g.

**Stop Cloudy Waters**

Get back the cloudy waters to obtain a cristal-clear water. 30g 6 tablet box.

**Stop Acque Torbide**

Recupera le acque torbide, la sua efficacia permette di avere un'acqua limpida e cristallina. Confezione di 6 pastiglie da 30g.



REF. SATC6

DIS PACK 12



**Stop Aguas Turbias**

Recupera las aguas turbias, y consigue un agua limpia y cristalina. **Para piscinas con filtro de cartucho.** Caja de 6 pastillas de 17g.

**Stop Eaux Troubles**

Traite les eaux troubles, et rend l'eau propre et cristalline. **Pour les piscines avec filtre à cartouche.** Boite carton de 6 pastilles de 17g.

**Stop Cloudy Waters**

Get back the cloudy waters to obtain a cristal-clear water. **For pools with cartridge filter.** 17g 6 tablet box.

**Stop Acque Torbide**

Recupera le acque torbide, la sua efficacia permette di avere un'acqua limpida e cristallina. **Per le piscine con filtro a cartuccia.** Confezione di 6 pastiglie da 17g.

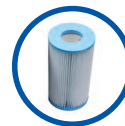

# producto químico **chemicals**

- Solución de tratamiento "Todo en Uno". Ideal piscinas elevadas con o sin filtración. Tratamiento mensual.  
 - 4 Acciones: Higienizante, Antibacterias, Antialgas y Floculante  
 - No hay manipulación directa de producto químico.

No perjudica la filtración gracias a su forma optimizada que deja el circuito de agua intacto. El POOLP'O sube a la superficie una vez acabado el producto químico, avisando de la necesidad de empezar un nuevo tratamiento.

- Solution de traitement "Tout en Un". Idéal Piscines hors-sol avec ou sans filtration. Traitement mensuel.

- 4 Actions: Hygiénisant, Anti-bactéries, Anti-algues, Floculant.  
 - Pas de manipulation directe de produit chimique.

Ne gêne pas la filtration grâce à sa forme optimisée qui laisse le circuit de l'eau intact. Ne gêne pas le volet du skimmer de part sa petite taille. Le POOLP'O remonte à la surface une fois le produit consommé vous avisant de la nécessité de recommencer un traitement.

- Treatment solution "All in One" for Above ground Pools with and without filtration. Monthly treatment.

- 4 actions: Sanitizing, Anti-bacteria, Anti-algae and Flocculant.  
 - No direct handling of chemical product. It does not obstruct filtration thanks to its form optimized – which leaves the circuit of water intact. It goes up once product finished, so you know you should start a new treatment.

- Soluzione "Tutto in uno". Adatto per piscine fuori terra con o senza filtrazione. Trattamento mensile

- 4 azioni: Igienizzanti, Anti-batteri, Antialghe e Floculante  
 - Non c'è contatto diretto con il prodotto chimico. Non danneggia la filtrazione grazie alla sua forma che lascia libero il circuito dell'acqua. Il Poolp'o sale in superficie una volta terminato il prodotto chimico, avvisando della necessità di dover iniziare un nuovo trattamento



REF. 08012

BX PACK 16



**POOLP'O 0-10m<sup>3</sup> (250g)**  
 POOLP'O 0-10m<sup>3</sup> (250g)

**POOLP'O 0-10m<sup>3</sup> (250g)**  
 POOLP'O 0-10m<sup>3</sup> (250g)

REF. 08112

DIS 18



Display **POOLP'O 0-10m<sup>3</sup> (250g)**  
 18 unidades  
**POOLP'O 0-10 m<sup>3</sup> (250g)** Display 18  
 unités

Display **POOLP'O 0-10 m<sup>3</sup> (250g)**  
 18 units  
 Display **POOLP'O 0-10 m<sup>3</sup> (250g)**  
 18 unità



REF. 08013A

BX PACK 16



**POOLP'O 10-20m<sup>3</sup> (500g)**  
 POOLP'O 10-20m<sup>3</sup> (500g)

**POOLP'O 10-20m<sup>3</sup> (500g)**  
 POOLP'O 10-20m<sup>3</sup> (500g)

REF. 08113

DIS 18



Display **POOLP'O 10-20m<sup>3</sup> (500g)**  
 18 unidades  
**POOLP'O 10-20m<sup>3</sup> (500g)** Display  
 18 unités

Display **POOLP'O 10-20m<sup>3</sup> (500g)**  
 18 units  
 Display **POOLP'O 10-20m<sup>3</sup> (500g)**  
 18 unità



REF. 08099A

BX PACK 9



**POOLP'O 10-30m<sup>3</sup> (700g)**  
 Dosificador flotante con tratamiento químico. Duración 3 semanas

**POOLP'O 10-30m<sup>3</sup> (700g)**  
 Chemical treatment floating dispenser.  
 3 weeks

**POOLP'O 10-30m<sup>3</sup> (700g)**  
 Doseur flottant chimique tout en un.  
 Durée 3 semaines.

**POOLP'O 10-30m<sup>3</sup> (700g)**  
 Dispenser galleggiante con  
 trattamento chimici. 3 settimane.

**KITS PISCINA POOL KITS**

**KITS POUR PISCINE KIT PER PISCINE**

REF. 76053

PACK 12



**Kit para piscina de 0 a 5m³**

Cloro lento pastillas de 5 g - 500 g  
+ Dosificador + Pelota

**Kit pour piscine de 0 à 5m³**

Chlore lent pastilles de 5 g - 500 g  
+ Doseur + Ballon

**Kit for 0-5m³ pool**

Trichlorine 5g tablets - 500 g +  
Dispenser + Ball

**Kit per piscine da 0 a 5m³**

Cloro lento pastiglie da 5 g - 500g +  
dosatore + palla gonfiabile



REF. 76054

PACK 6



**Kit para piscina de 5 a 15m³**

Multifunciones pastillas 20g, 1Kg +  
Dosificador + Termómetro + Analizador  
+ Manguitos + Kit reparación liner

**Kit pour piscine de 5 à 15m³**

Multifonction pastilles 20g, 1 kg + Doseur +  
Thermomètre + Trousse  
d'analyse + Brassards + Kit réparation liner

**Kit for 5-15m³ pool**

Multiactions 20g tablets, 1Kg +  
Dispenser + Thermometer + Test kit  
+ Arm-bands + Liner repair kit

**Kit per piscine da 5 a 15m³**

4 azioni pastiglie da 20g, formato 1 Kg  
+ Dosatore + termometro + Kit analisi  
+ Bracciali + Kit riparazione liner



REF. KTSPAE

REF. KTSPA

REF. KTSPAIT



**Kit tratamiento para Spa**

Spa desinfectante 20g x4 + pH plus  
20g x2 + pH menos 30g x2

**Kit traitement pour Spa**

Spa desinfect 20g x4 + augmente  
pH 20g x2 + baisse pH 30g x2

**Kit with chemical treatment for Spa**

Spa disinfect 20g x4 + pH reduce 20g x2 +  
pH increase 30g x2

**Kit trattamento per Spa**

disinfezione Spa 20g x4 + incrementatore  
pH 20g x2+ riduttore pH 30g x2



DIS PACK 12

REF. 778776

PACK 12



**Clean SPA 3 en 1**

Pastillas de 20 gr - 1 Kg.

**Clean SPA 3 in 1**

20g tablets, 1Kg

**Clean SPA 3 en 1**

Pastilles 20g, -1 kg

**Clean SPA 3 in 1**

Pastiglie da 20g, formato 1 Kg



Referencia no disponible para España

### JUNIOR POOL

REF. KKP525

DIS PACK 18



8 4 1 2 0 8 1 2 7 2 5 9 7

**Kit tratamiento químico para piscinas pequeñas sin filtración**  
5 bolsas de 25 ml  
**Kit traitement chimie pour petites bassins sans filtration**  
5 x 25 ml

**Disinfection for small pools without filter**  
5 x 25 ml  
**Kit trattamento per piscina piccola senza filtrazione**  
5 x 25 ml



### TESTERS DIGITALES DIGITAL TESTERS TESTEURS DIGITAL TESTER DIGITALE



REF. 40817

BL PACK 12



0 9 0 9 4 4 0 2 0 8 2 0 8

Recambio para el Aquacheck True Test: 25 tiras analíticas.

Aquacheck True Test refill: 25 test strips.

Recharge pour Aquacheck TruTest.: 25 languettes d'analyse

Ricarica di Aquacheck TruTest: 25 strisce di analisi.



REF. 38813

CS PACK 6



0 9 0 9 4 4 1 0 4 0 0 3 6

**Aquacheck**  
Lector digital de tiras de análisis TruTest. Analiza los niveles de cloro/bromo libre, valor pH y alcalinidad total.

**Aquacheck**  
Digital Test Strip Reader. Tests for: Free Chlorine, pH, Total Alkalinity.

**Aquacheck**  
Lecteur digital de bandelettes d'analyse TruTest. Résultats de Chlore/Brome libre, pH et Alcalinité totale.

**Aquacheck**  
Digital Test striscia lettore TruTest: cloro / bromo-libero, il pH e l'alcalinità totale.

# produits d'entretien | prodotti chimici



REF. 40068

1/8 BL PACK 16



Análisis cloro + pH + alcalinidad  
(50 tiras).

Analyse chlore + pH + alcalinité  
(50 languettes).

Chlorine + pH + alkalinity analysis  
(50 strips).

Analisi cloro + pH + alcalinità  
(50 strisce).



REF. 40069

BX PACK 12



Analiza el nivel de sal en agua  
(16 tiras).

Analyse le niveau de Sel de l'eau  
(16 languettes).

Salt level in water analysis  
(16 strips).

Analizza il livello di sale nell'acqua  
(16 strisce).

## MONODOSIS MONODOSE MONODOSE MONODOSI



REF. UFG90

DIS PACK 36



**Ultraflock**  
Gel floculante en monodosi de 90g.

**Ultraflock**  
Floculant Gel gousse de 90g.

**Ultraflock**  
Flocculant Gel 90g pods.

**Ultraflock**  
90g flocculante gel.

**ANALIZADORES TEST KITS**  
**TROUSSES D'ANALYSE KIT TEST**

REF. 40060

BL PACK 16



Analizador de cloro/bromo + pH (Oto/  
Phenol)

Trousse chlore/brome + pH (Oto/Phénol)

Test kit chlorine/bromine + pH (Oto/  
Phenol)

Kit analisi cloro/bromo + pH (oto/  
Phenol)



REF. 40061

BL PACK 12



Recambio Oto/Phenol  
Recharge Oto/Phénol

Refi II Oto/Phenol  
Ricambio Oto/Phenol



REF. 40062

DIS 1/8 CS PACK 24



Comparador cloro + pH - pastillas DPD1  
Trousse chlore + pH - pastilles DPD1

Test kit chlorine + pH - DPD1 tablets  
Kit analisi cloro + ph - pastiglie DPD1



REF. 40063

DIS 1/8 BL PACK 24



Recambio pastillas DPD1  
Recharge pastilles DPD1

Refi II DPD1 tablets  
Ricarica pastiglie DPD1



# produits d'entretien

# prodotti chimici



REF. 40066

DIS 1/8 CS PACK 24



Kit de análisis de oxígeno/bromo + pH -  
pastillas DPD4

Trousse de oxygène/brome + pH pastilles  
DPD4

Oxygen / bromine + pH test kit - DPD4  
tablets

Kit analisi ossigeno/bromo + pH  
pastiglie DPD4



REF. 40067

DIS 1/8 BL PACK 24



Recambio pastillas DPD4

Recharge pastilles DPD4

Refi II DPD4 tablets

Ricarica pastiglie DPD4

# material plv pos material matériels plv materiale pos



EXPOSITOR PISCINA CHAPA STEEL POOL EXHIBITOR EXPOSANTS PISCINE ACIER EXPOSITORI PISCINE PARETI IN ACCIAIO



TOTEMS CARTÓN CARDBOARD TOTEMS TOTEMS CARTON TOTEMS CARTONE



TOTEM ENTERRADAS  
IN GROUND POOLS TOTEM  
TOTEM PISCINES ENTERRÉES  
TOTEM PISCINE INTERRATA

EXPOSITOR ROBOTS  
ROBOTS EXHIBITOR  
EXPOSANTS ROBOTS  
EXPOSITORI ROBOTS



PISCINA DE EXPOSICIÓN  
EXHIBITOR WOODEN POOL  
EXPOSANT PISCINE BOIS  
EXPOSITORI PISCINA IN LEGNO





Nos reservamos el derecho de cambiar total o parcialmente las características de nuestros artículos o el contenido de este documento sin previo aviso. Fotos e imágenes no contractuales.

We reserve the right to change all or part of the articles or contents of this document without prior notice. Photos and pictures are not contractual.

Nous nous réservons le droit de modifier totalment ou en partie les caractéristiques de nos articles ou le contenu de ce document sans préavis. Photos et images non contractuelles.

Ci riserviamo il diritto di cambiare totalmente o parzialmente le caratteristiche tecniche dei nostri prodotti ed il contenuto di questo documento senza nessun preavviso. La Fotografia o il disegno è solo a scopo illustrativo ed informativo.

**Sede social Headquarters Siège social Sede centrale**

Manufacturas GRE S.A. | Aritz Bidea nº 57 | Belako Industrialdea | Apartado 69 | 48100 Mungia (Bizkaia) Spain  
Tel. (34) 946 741 116 | Fax (34) 946 741 708 | gre@gre.es

**Bureau Commercial France**

Pintor Velazquez nº10 | 08213 Polinyà (Barcelona) | Spain  
Tel : 09 73 32 57 01 | Fax : 09 73 32 57 00 | gre@grefrance.fr

**Servicio Postventa After-sales service Service après vente Servizio post-vendita**

**WWW.SERVICE-GRE.COM**

**www.gre.es**





[www.gre.es](http://www.gre.es)

Manufacturas GRE S.A. | Aritz Bidea nº 57 | Belako Industrialdea | Apartado 69 | 48100 Mungia (Bizkaia) Spain  
Tel. (34) 946 741 116 | Fax (34) 946 741 708 | [gre@gre.es](mailto:gre@gre.es)



**FLUIDRA**