

be  
ha  
ppy



# Es pa ña

Inspired, designed  
and made in Spain





Newgarden emerged by the sea, lying on the beach, where the sun and waves were the protagonists, transmitting peace and happiness. A feeling that will fill any space and connect it with the most pleasant part of the day.

Light, colour, design and sound - a different way of seeing life with a Mediterranean touch



# Newgarden Studio

The design is something complex, unique and unrepeatable, arising from an idea with a touch of heart. At Newgarden we create our designs until they become a member of our family. Each and every one of our products receives the greatest attention from our designers and engineers, making them ahead of their time, innovative and, above all, original.



*Valerio Scammella*

Born in Tuscany, Valerio has always been closely influenced by the Mediterranean, and that is reflected in each of his designs. He has proven to be one of the most innovative international designers. At Newgarden we have had the pleasure of collaborating with him to create unique and original products with a Mediterranean touch.

achodoso®

Difference is clearly Achodoso's key to success. Two young product design students, creating innovative and, above all, simple products. That's why at Newgarden we are delighted to have collaborated with them designing Helga.





FITY	16
CHLOE	18
ROCKET	20
HELGA	22
PANCHO	24
LOLA 110/165/200	26
CARMEN 110/165	28
FREDO 140/170	30
KONIKA 170	32
GRACE 140/170	34
LOLA SLIM	36
KAKTUS	37
BALANS	38
GOA	38
GUFO	40

SAMBA	41
RUDY	42
AMELIO	44
SNOWY 40/100	46
PINUS	48
NOVA 45/60	50
KLAUS	51
NORAI	52
CANDELA	54
NOMADA SOLAR	54
KURBY SOLAR	55
FARALAY SOLAR	55
LOLA 20/30/45	56
CARMEN 45	57
MAFALDA	57

NIPPER	58
PIPA	59
ROBIN PLAY	60
FARALAY PLAY	61
NOMADA PLAY	62
KURBY PLAY	63
CUBY PLAY	64
CUBY WIFI	65
WALL	66
CLAUDY	68
BALBY HANG	70
BULY HANG	71
PETRA HANG	72
PETRA	73
BULY FAMILY	74
CUBY FAMILY	76

# Light & Deco



FORMENTERA	80
NEW ISLAND	82
SET TARIDA	86
CAPRI 75 & MALLORCA	90
ITACA & MALLORCA	91
MENORCA SOFÁ	92
MENORCA BENCH	93
CALVIN & MELVIN	94

CUBY PLAY	95
CUBY	96
BETTY USB	97
BRICKY	98
SICILIA	102
IBIZA & CRETA	104
PALMA BOTTLE RACK	106
WOODY	107

CAPRI 110 & CORFU 74	108
BAHAMA	110
PUFY & TAFY	111
CAPRI 40 & CORFU 40	111

# Furniture

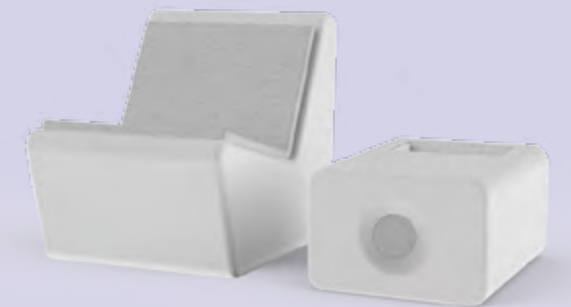

MAGNOLIA FAMILY	114
MELISA 30/40/50	116
FICUS 60/80	118
BAMBÚ 70/90	119
PALMERA	120
JUNCO	121

JARA	122
NARCISO 40/50/60	123
CAMELIA FAMILY	124
PALMA	125
HIEDRA	127
GERBERA	128

VIOLETA	129
---------	-----

# Flower pots

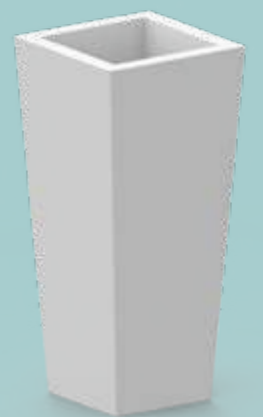

# Light & Deco

Light illuminates us in the dark and shows us the way. Being able to change our mood in just seconds. With our products we strive to make your day brighter. Fill each space with light in a variety of colours and products offered by Newgarden.

Light, technology, colour, design and endless sensations to discover.







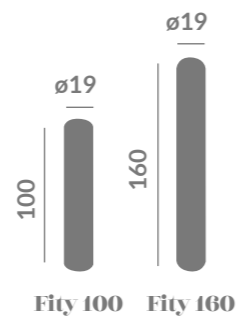

# Fity



Options  
Light

-  Cable
-  Wireless + Solar ☀️

+ Info P. 139



# Chloe

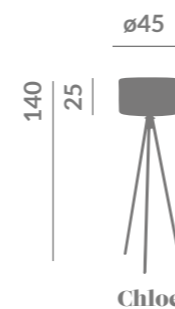

Options  
Light

- Cable
- Wireless + Solar 

+ Info P. 139



# Rocket

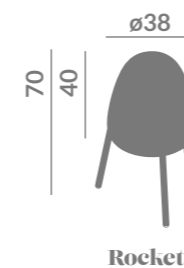

## Options Light

-  Cable
-  Wireless + Solar

+ Info P. 139

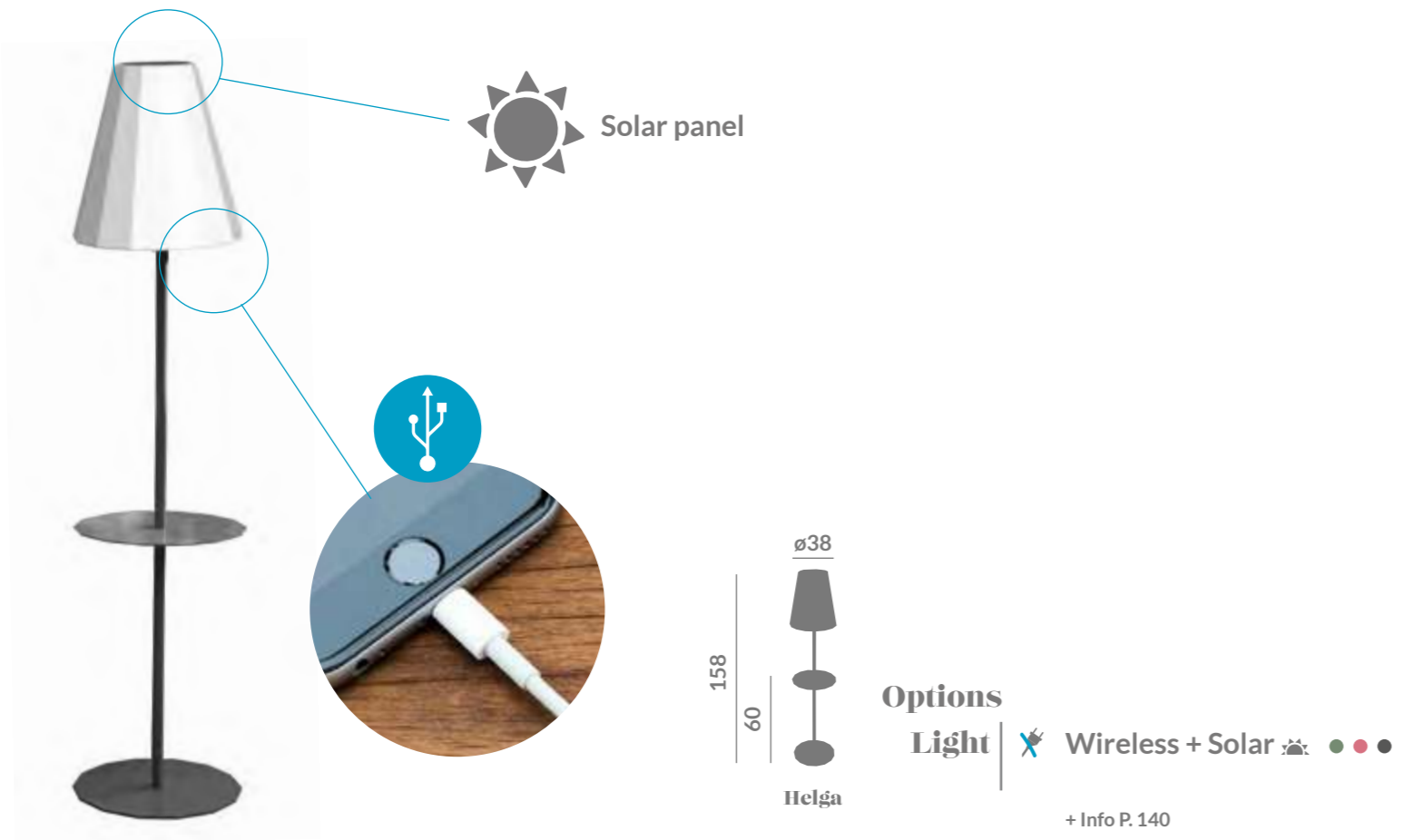

# Pancho

## Options

### Light

- Cable
- Wireless + Solar

140

61x43



Pancho

+ Info P. 141

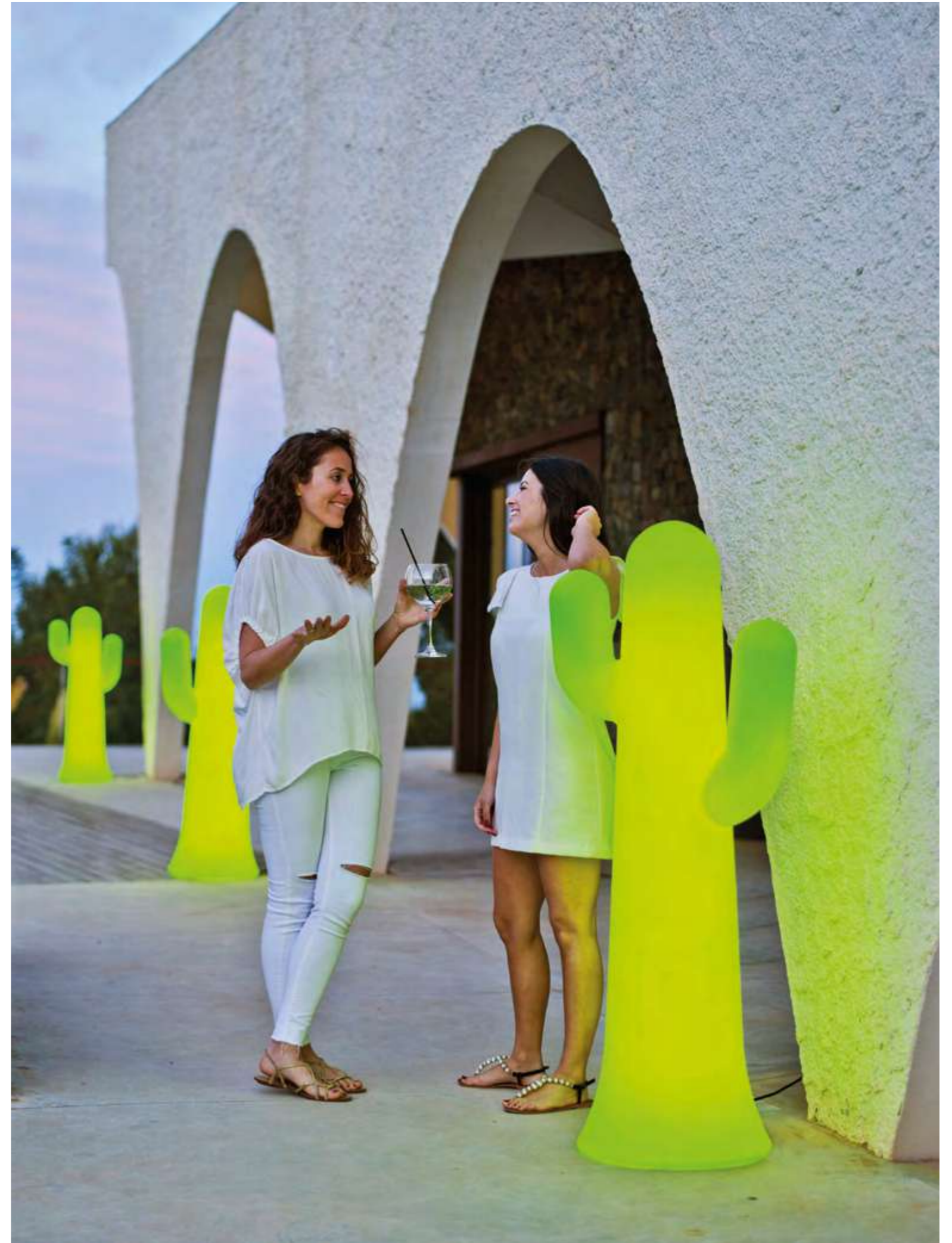

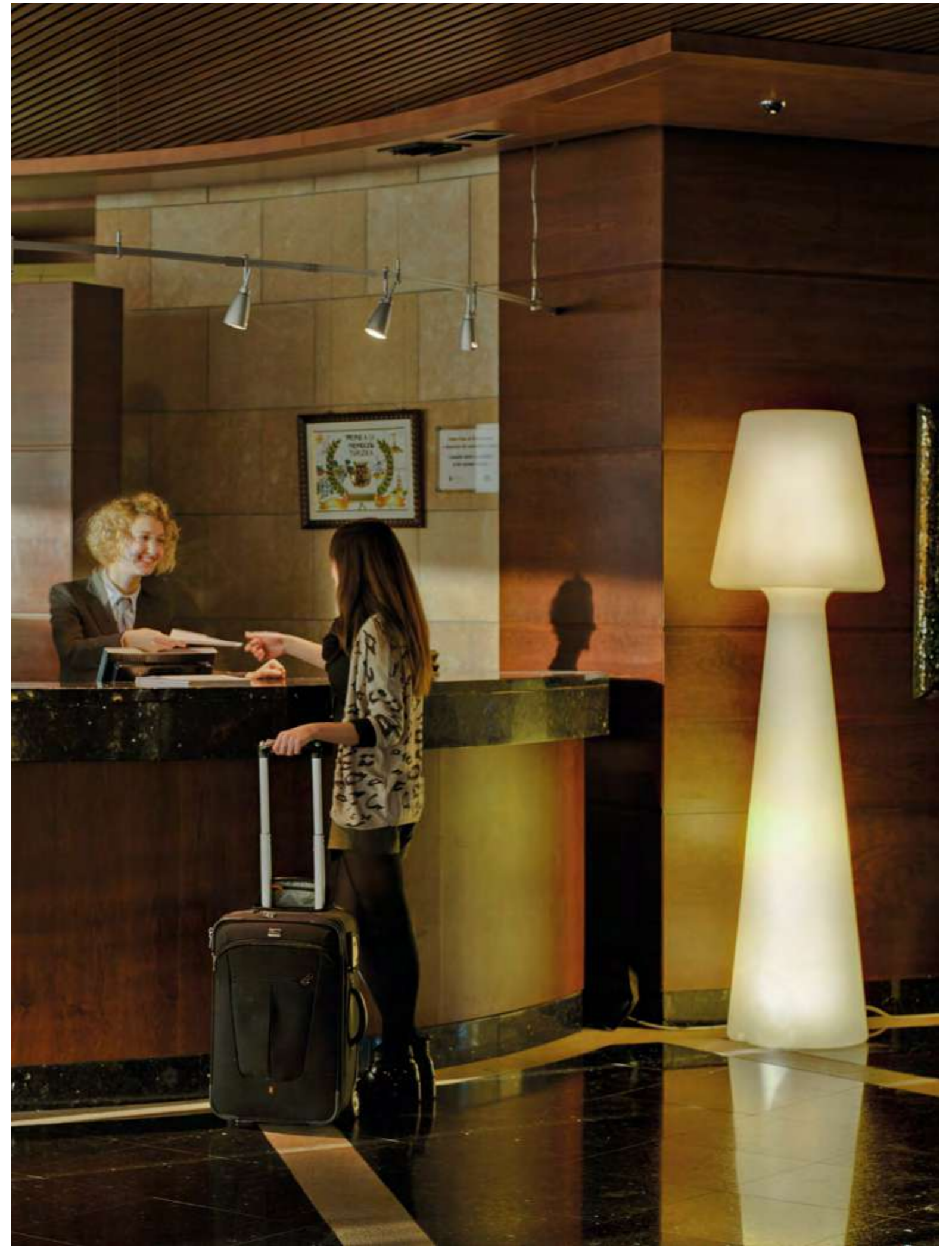

# Lola

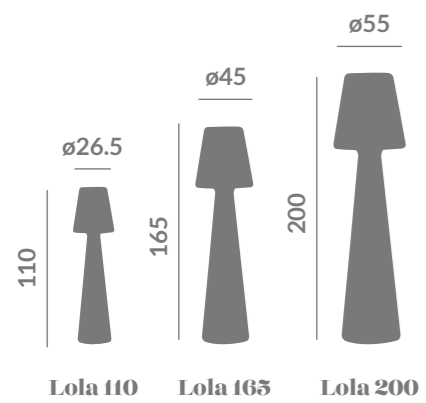

Options  
Light

- Cable
- Wireless

+ Info P. 141





# Carmen

Options

Light



Cable



Wireless

+ Info P. 142

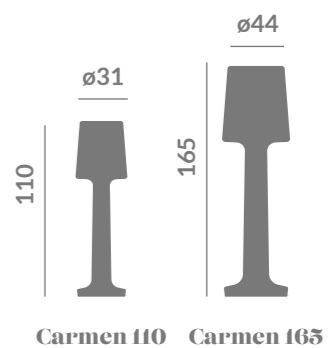



# Fredo



**Options**

Light



Cable



Wireless + Solar

+ Info P. 142

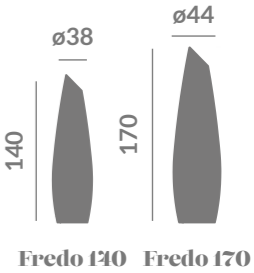



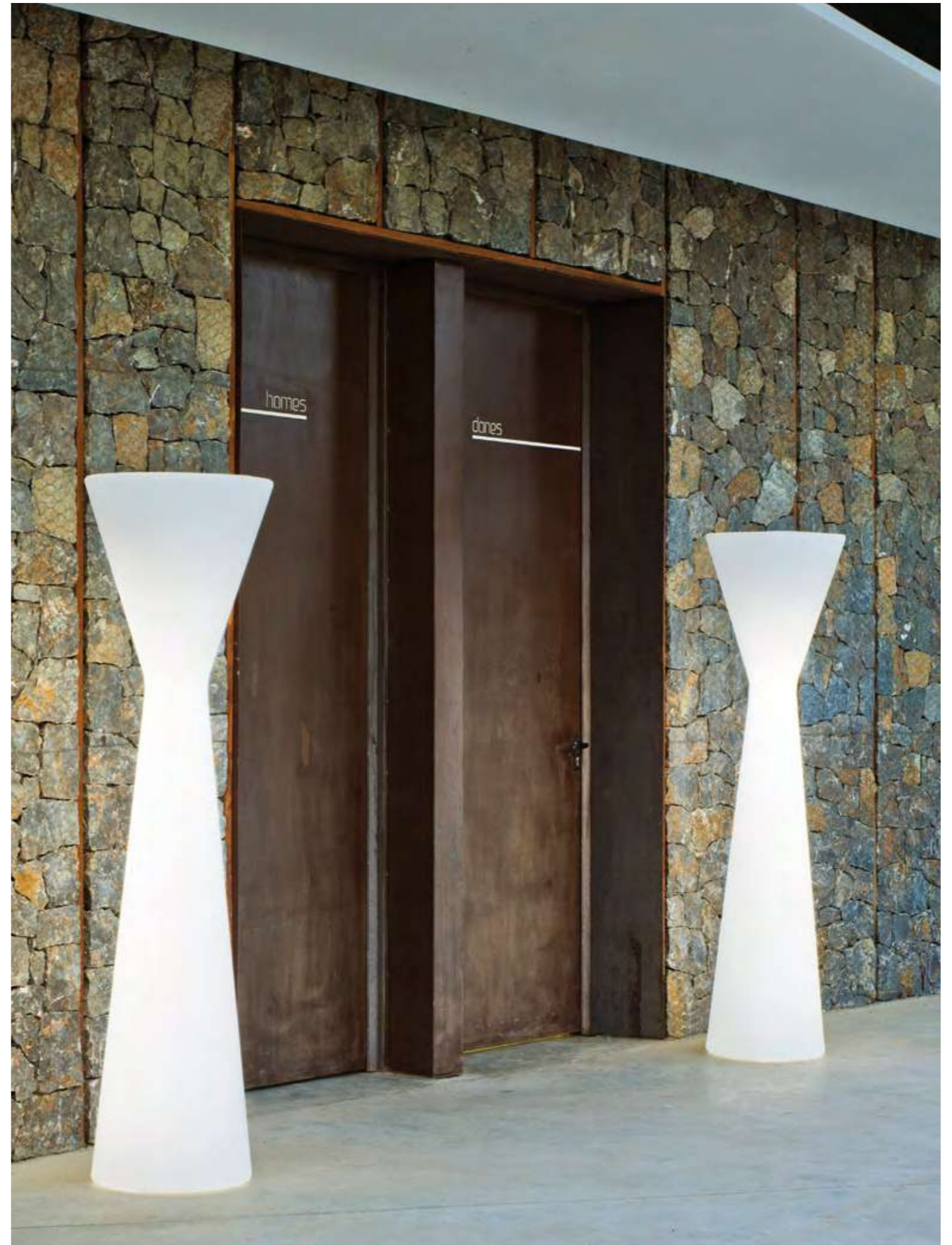

# Konika

Options

- Light |  Cable
- |  Wireless

+ Info P. 142



# Grace



## Options

Light



Cable



Wireless

+ Info P. 140



Grace 140

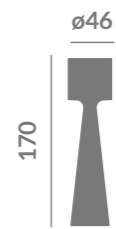

Grace 170





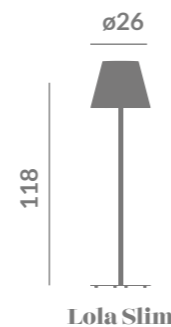

# Lola slim



Options  
Light |  Cable  + Info P. 140



# Kak tus

Options  
Light |  Cable   Wireless + Solar  + Info P. 140

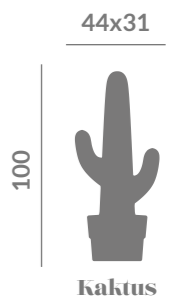

# Balans

## Options

- Light  Cable  Wireless + Solar ☀️

+ Info P. 142



# Goa

## Options

- Light  Cable  Wireless + Solar ☀️

+ Info P. 143



# Gufo

Options  
Light

- Cable
- Wireless + Solar

+ Info P. 143



Gufo 30

# Samba

Options  
Light

- Cable
- Wireless

+ Info P. 143



Samba





# Rudy

Options

Light



Cable



Wireless + Solar



+ Info P. 143

40x30



40

Rudy





# Amelio



**Options**

- Light  Cable
- Wireless + Solar ☀️

+ Info P. 144



Amelio



**Options**

**Light**

- Cable
- Wireless + Solar ☀️

+ Info P. 144, 145

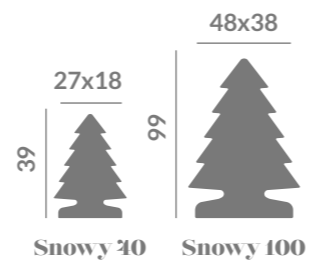



Options  
Light

- Cable ●●
- Wireless + Solar ☀●

+ Info P. 144



# Nova

## Options

Light | Cable  
Wireless + Solar

+ Info P. 145



# Klaus

## Options

Light | Play light&music

+ Info P. 145

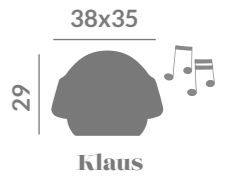



# Norai



Options  
Light

Wireless

+ Info P. 145

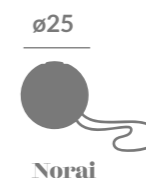



# Can dela

Options

Light |  Cable  
 Wireless  
+ Info P. 146



Candela

# Kur by

Options

Light |  Wireless + Solar ☀️  
+ Info P. 146



Kurby



# Nóma da

Options

Light |  Wireless + Solar ☀️  
+ Info P. 146



Nómada

# Fa ra lay

Options

Light |  Wireless + Solar ☀️  
+ Info P. 146

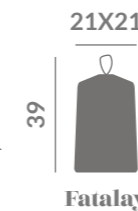

Fatalay



*take me where  
you want!*



Lola 45

# Lola

Options

- Light
- Cable
- Wireless

+ Info P. 146, 147



Lola 20 Lola 30 Lola 45



Lola 20



Lola 30

# Carmen

Options

- Light
- Cable
- Wireless

+ Info P. 147

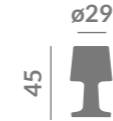

Carmen 45



# Mafalda

Options

- Light
- Cable
- Wireless

+ Info P. 147



Mafalda





**Nipper**

Options  
 Light | Play light&music   
 + Info P. 148

29x26  
 39   
 Nipper

**Pipa**

Options  
 Light | Play light&music   
 + Info P. 147

19x18.5  
 30   
 Pipa

*Nobli Formella*

Light and Deco / Speakers / Pipa - Nipper

# Robin play



Options

Light



Play light&music



+ Info P. 148

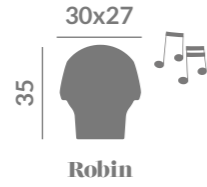

Robin



# Faralay play

Options

Light



Play light&music



+ Info P. 148

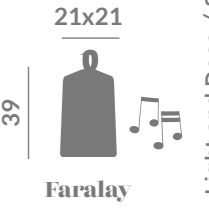

Faralay





# Nómada play

Options  
Light

✦ Play light&music

+ Info P. 148

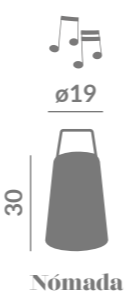

Options  
Light

✦ Play light&music

+ Info P. 148

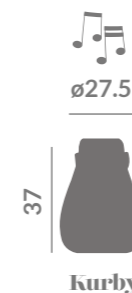

# Kurby play





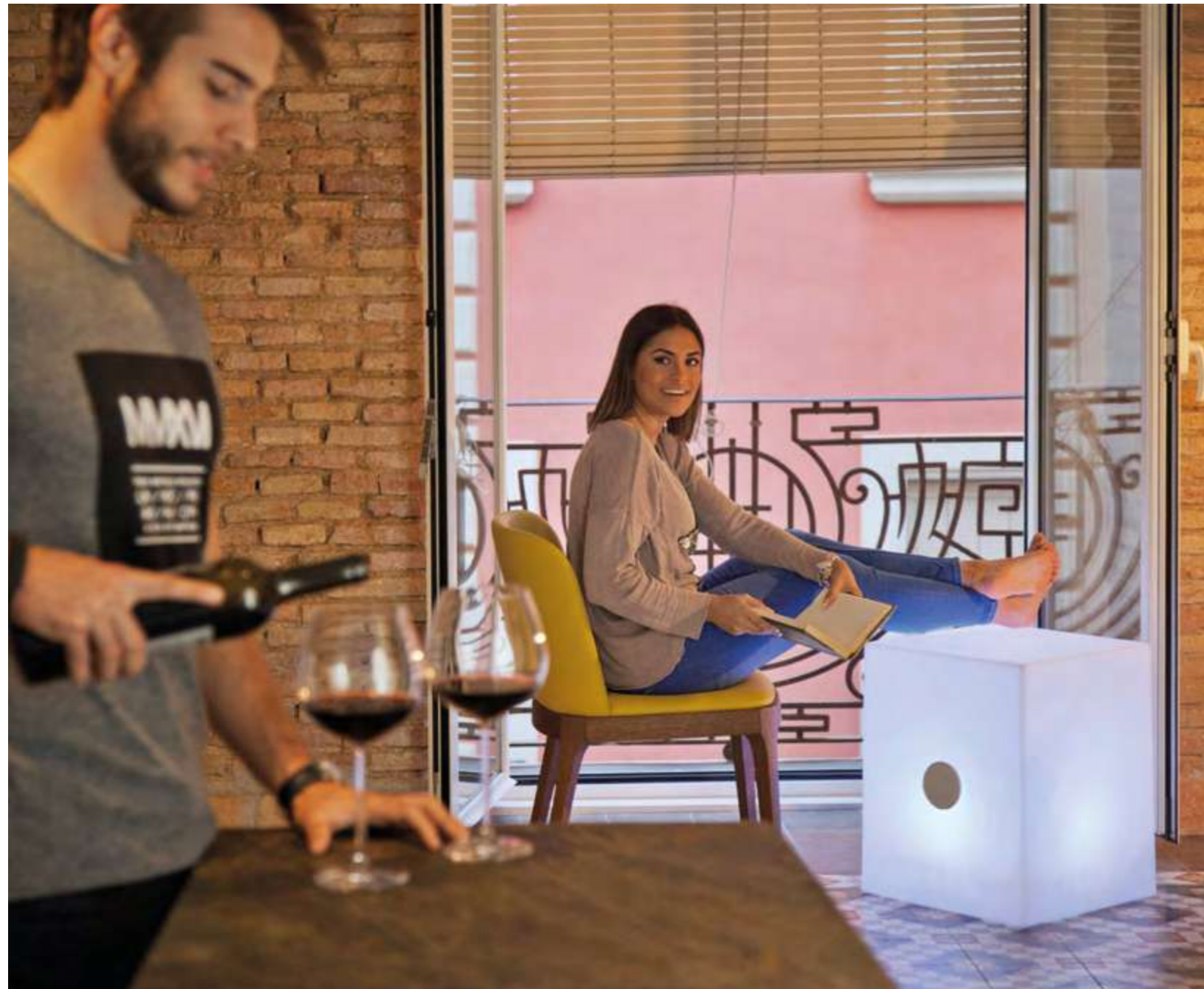





# Cuby play

**Options**

**Light** | **Play light&music** 

+ Info P. 149,156

			
20x20	32x32	43x43	53
Cuby 20	Cuby 32	Cuby 45	Cuby 53



# Cuby wifi

**Options**

**Light** | **Cable** 

+ Info P. 149

43x43
43
Cuby 45



# Lola wall







# Cápsula terpe



# Buly wall

**Options**  
Light | Wall  + Info P. 149, 150

20x26 35 	15x22 30 	ø20x17 20 	20x20 
Lola wall	Cápsula terpe	Buly wall	Cuby wall





# Claudy

Options

Light

↑ Hang  • • • 20  
+ Info P. 150



50x40



Claudy



# Balby hang

ø31  
 52  
  
**Balby hang**  
**Options**  
**Light | Hang**    
 + Info P. 150



# Bulby hang

ø30  
 26.5  
  
**Bulby 30 hang**  
**Options**  
**Light | Hang**    
 + Info P. 151



# Petra hang

## Options

- Light | ↑ Hang 🌟
- ✂ Cable
- ✂ Wireless + Solar ☀️

+ Info P. 151, 153

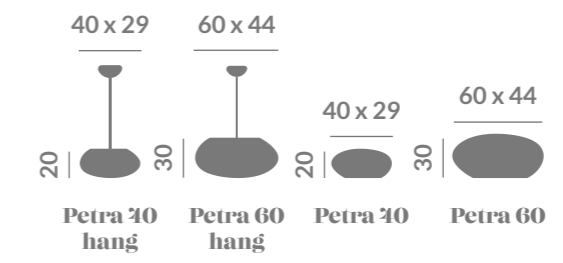

# Petra



# Bully

*Do you prefer it with white light or with 256 colours?*

*Do you want it with solar & battery charge or with cable?*

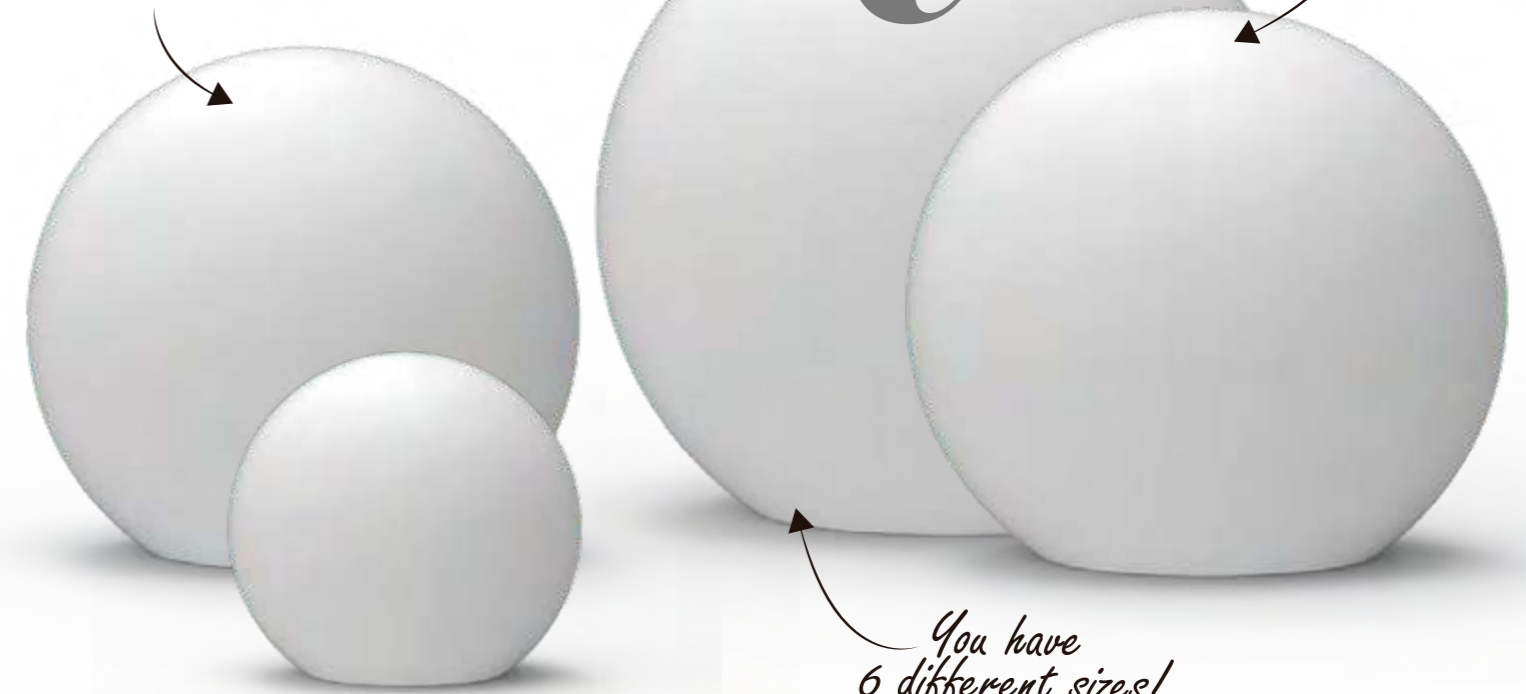

*You have 6 different sizes!*

LED

*choose your best option*

6 Sizes	Wireless	Solar charge & Rechargeable Battery	Cable	Floating
Remote Control	Colorfull Lighting	White Light	Translucent White	Translucent Granite

## Options

- Cable
- Wireless + Solar
- Floating

+ Info P. 151, 152

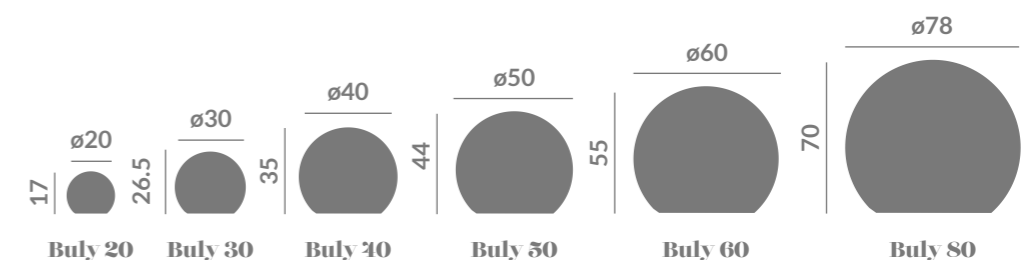

# Cuby



## Options

Light



Cable



Wireless + Solar

+ Info P. 152, 153

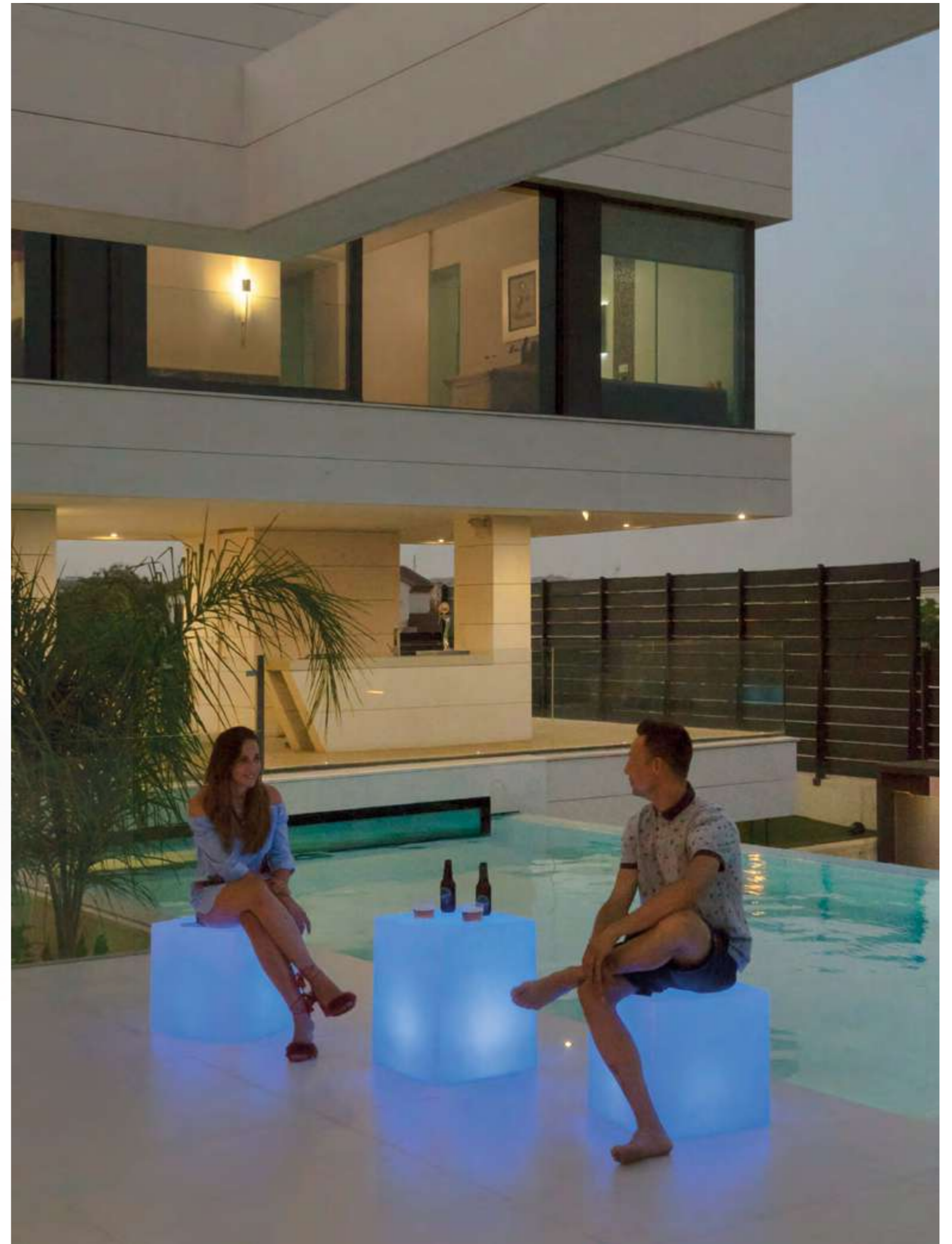
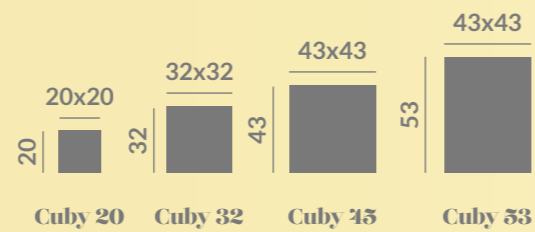

# Furniture

**Originality** makes the difference, it attracts **curiosity** and transmits special **feelings**, with a different and innovative touch. A safe bet if you want to **escape** from your routine and enter a **world** full of state-of-the-art and daring ideas, provided by Newgarden.

Trends, lights, shapes and, above all, best **friends**.







**Options**

- Light  Cable
- Wireless + Solar 

Color

**Textile accessories**

+ Info P. 156

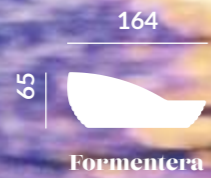



# New Island



# Jamaica, Aruba & Martinica

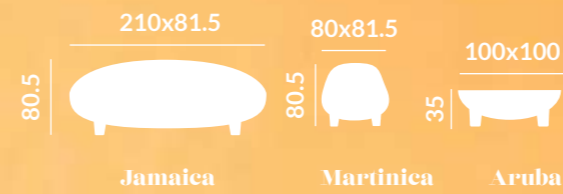

## Options

- Light | Cable  
 Wireless + Solar

- Color | ● ● ●  
+ Info P. 155,156

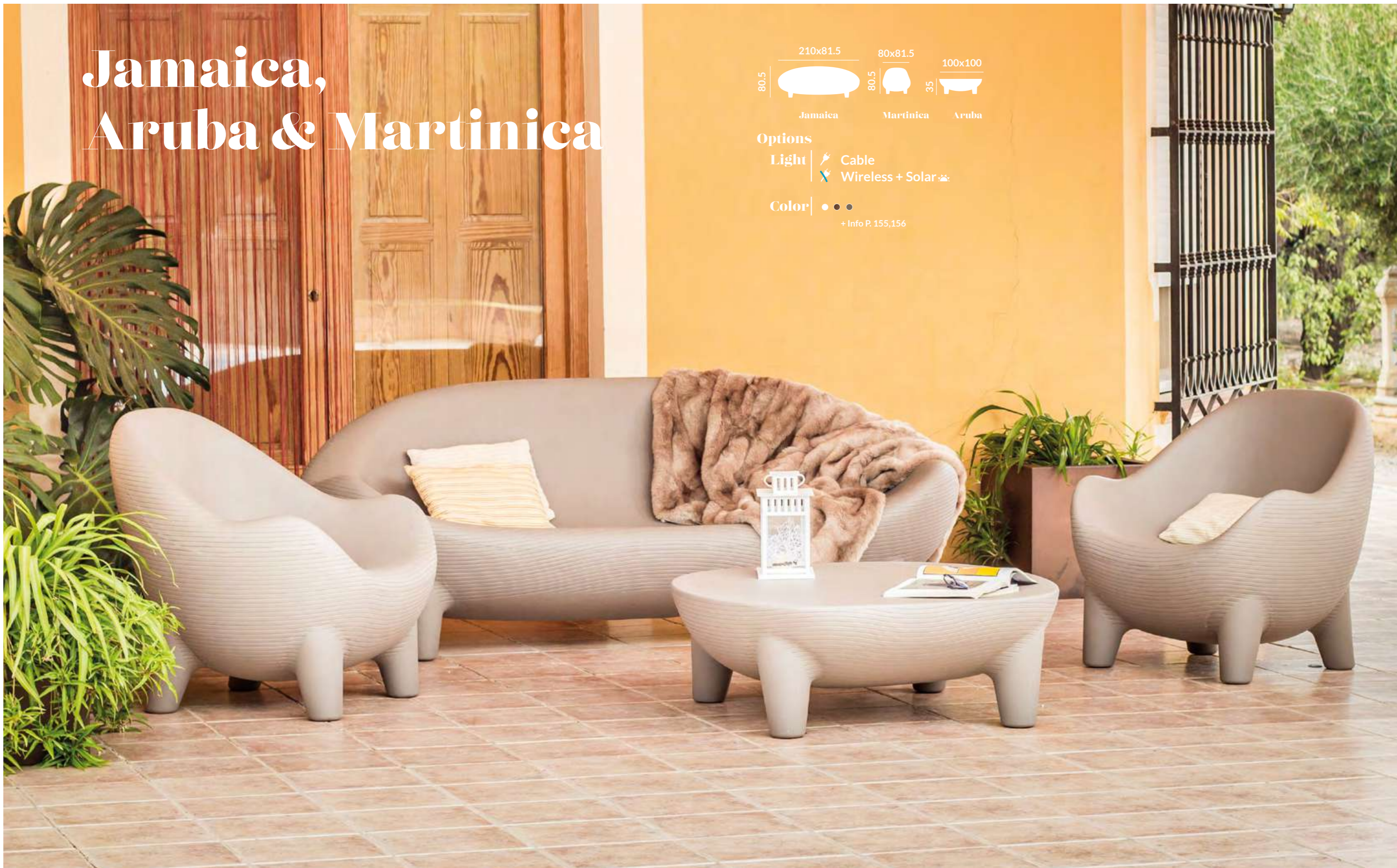



# Tarida Set

## Options

- Light**
- Cable
  - Wireless + Solar ☀️
  - Play light&music 🎵

**Color** ○ ● ● ●

+ Info P. 155, 157



Tarida sit Tarida tab

Tarida sit textil accessory included  
Tarida tab cover included





# Capri & Mallorca



# Itaca & Mallorca

## Options

Light |  Cable  
 Wireless + Solar ☀️

Color |

+ Info P. 154, 155, 157

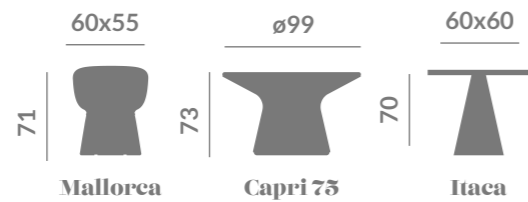

Tables cover included  
 Itaca weight stability included



# Menorca sofá

## Options

Light  Cable  
 Wireless + Solar

Color

+ Info P. 157



Menorca  
sofá



# Menorca bench

## Options

Light  Cable  
 Wireless + Solar

Color

+ Info P. 157

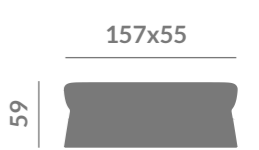

Menorca  
bench





# Calvin & Melvin

## Options

**Light** ✕ Wireless + Solar ☀️  
✕ Play light&music 🎵

**Color** ○ ● ●

+ Info P. 154, 157

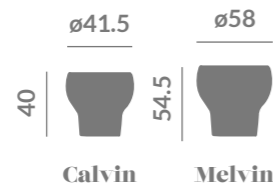

Melvin cover included



# Cuby play

## Options

**Light** ✕ Play light&music 🎵

+ Info P. 149, 156

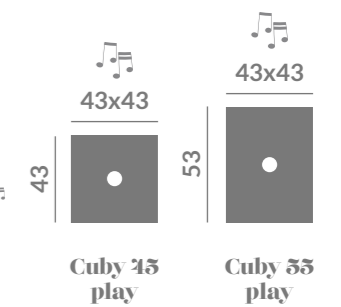





Cuby



Betty usb

Options

- Light
- Cable
- Wireless + Solar

+ Info P. 155

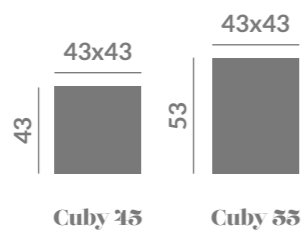

Cuby 45

Cuby 55

Options  
Light

- Cable

+ Info P. 156

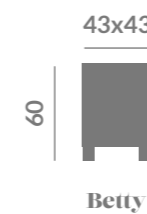

Betty

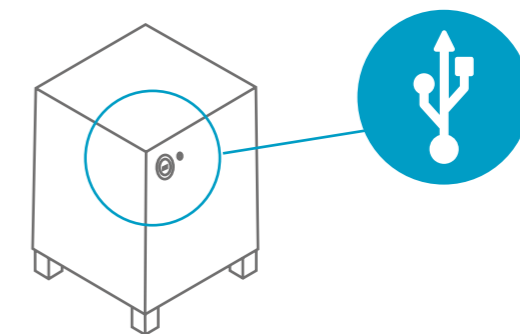



# Bricky

*Get creative!*

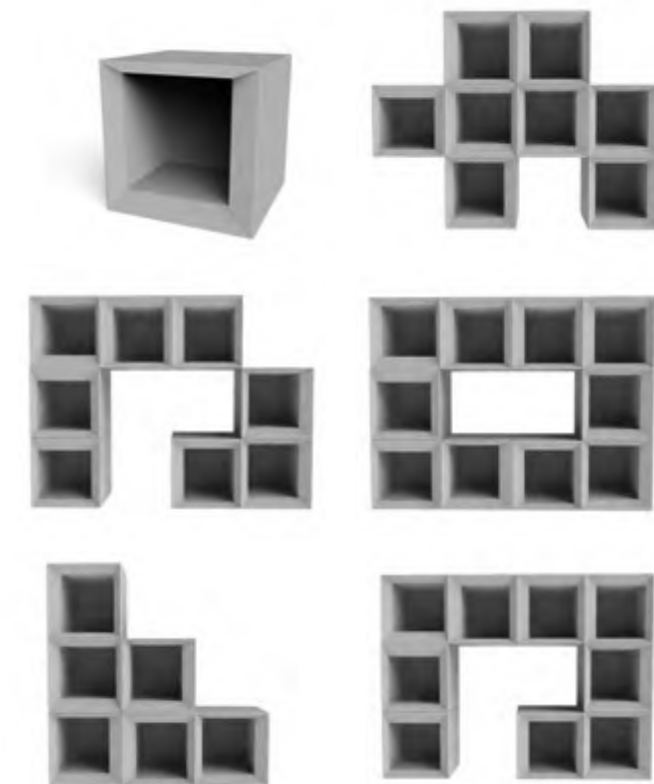

**Options**

Light |  Cable

Color |    

+ Info P. 158

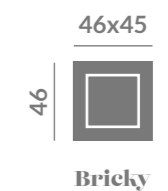





# Sicilia

## Options

- Light  Cable
- Wireless + Solar 

## Color

+ Info P. 159



Sicilia 75



Sicilia 120

# Ibiza



## Options

- Light  Cable  Wireless + Solar ☀️

Color

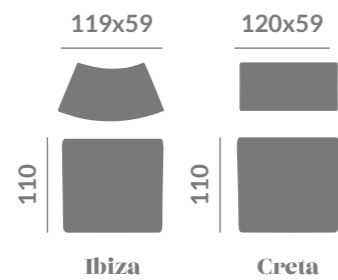

+ Info P. 159

Cover included

# Creta





## Palma bottle rack

### Options

Light

- Cable
- Wireless + Solar

Cooler accessory



+ Info P. 159

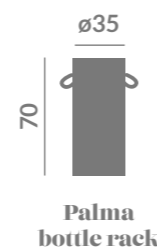

## Woody

### Options

Light

- Play light&music

Cooler accessory included





+ Info P. 160



# Capri & Corfu



## Options

Light |  Cable  
 Wireless + Solar 

Color | 

+ Info P. 154, 158



Capri cover included

# Bahama

**Options**

Light | Wireless + Solar

Color |

+ Info P. 154

Cover included



Bahama



# Pufy & Taty

**Options**

Color |

+ Info P. 158

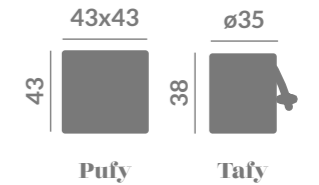

Pufy

Taty



# Capri & Corfu

**Options**

Light | Wireless + Solar

Color |

+ Info P. 154, 158

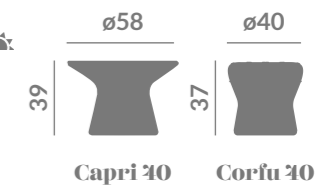

Capri 40

Corfu 40

Capri cover included



# Flowerpots

Life emanates from plants, capable of bringing unique sensations of peace to every corner and attracting all eyes. The range of Newgarden planters has managed to capture that feeling along with unique and innovative designs. Giving your garden an original touch and a feeling of tranquillity.

Nature, life, harmony... and endless possibilities to be explored.

# Flowerpots





**Options**

- Light** | Cable  
 Wireless + Solar

- Color** |

+ Info P. 163, 164

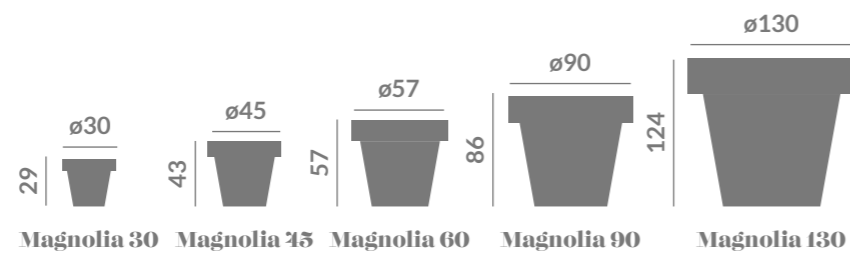

**Magnolia**

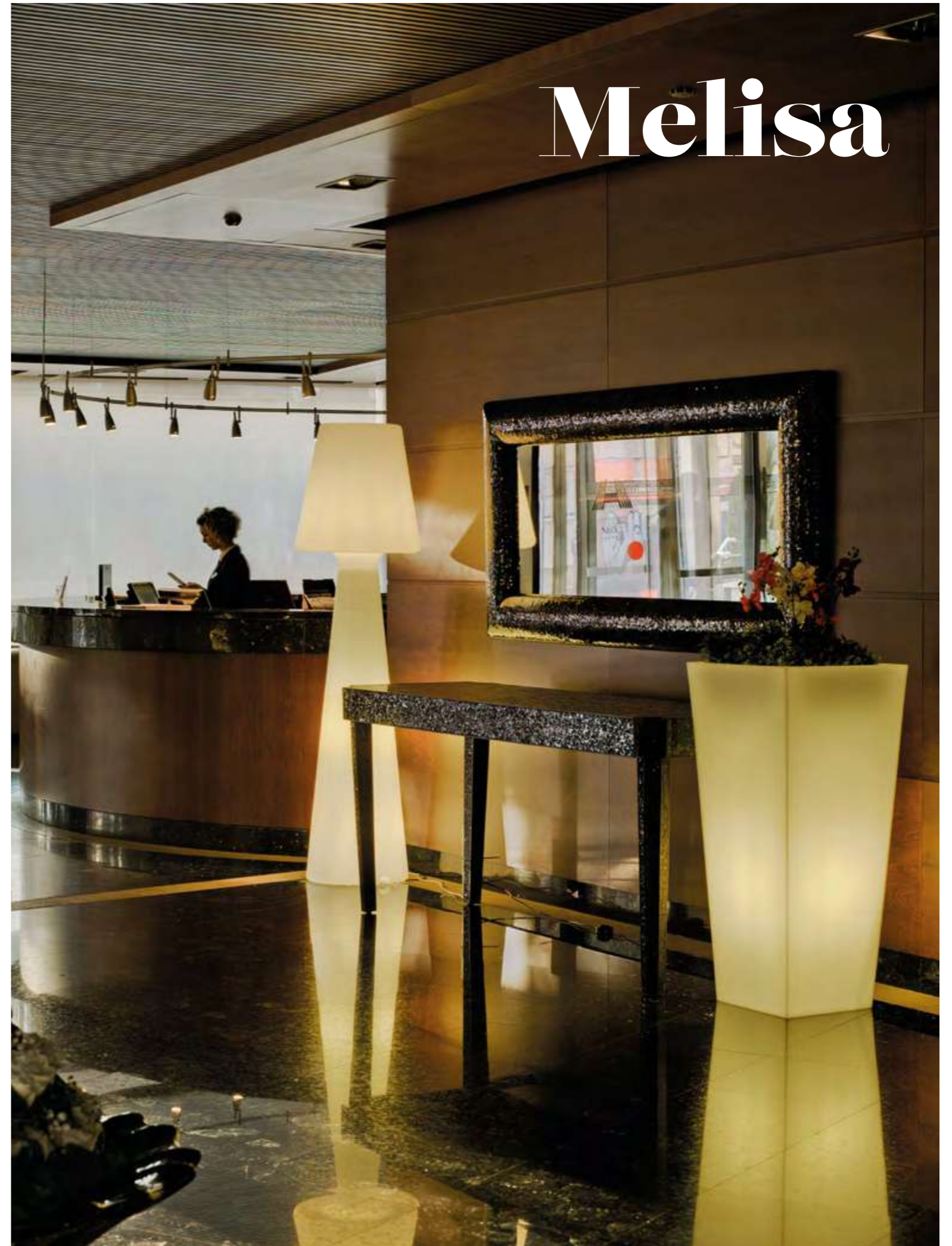

**Options**

- Light** |  Cable  Wireless + Solar ☀️

- Color** |
- + Info P. 164, 165

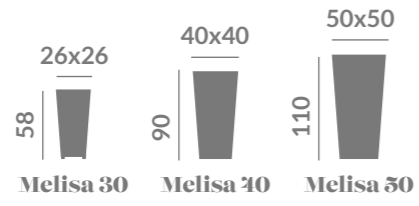



**Options**

- Light** |  Cable  Wireless + Solar ☀️

- Color** |

+ Info P. 161, 162

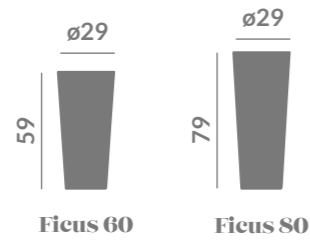

**Ficus**

**Options**

- Light** |  Cable  Wireless + Solar ☀️

- Color** |

**Cooler accessory** 

+ Info P. 160

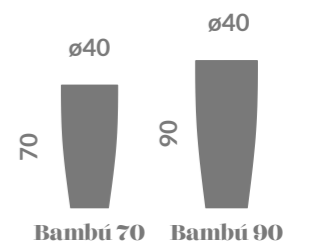

**Bambú**



**Options**

- Light** |  Cable  Wireless + Solar ☀️

- Color** |

+ Info P. 166

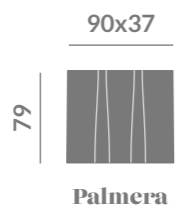

# Palmera



**Options**

- Light** |  Cable  Wireless + Solar ☀️

- Color** |

+ Info P. 163

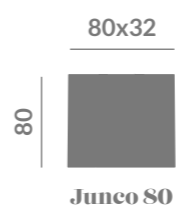

# Junco





# Jara

## Options

Color | ○ ● ● ● ● ●

+ Info P. 163

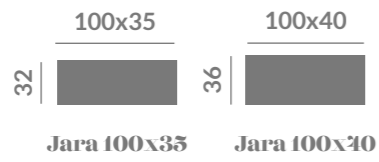

# Narciso

## Options

Light | ✂ Cable  
✕ Wireless + Solar ☀

Color | ○ ● ● ● ● ● ● ● ● ● ●

+ Info P. 165

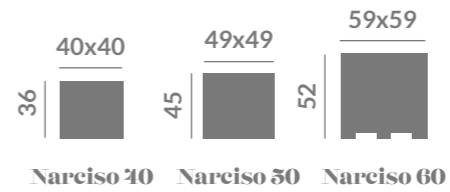

Options

Light  Cable  
 Wireless + Solar

Color 

+ Info P. 160, 161

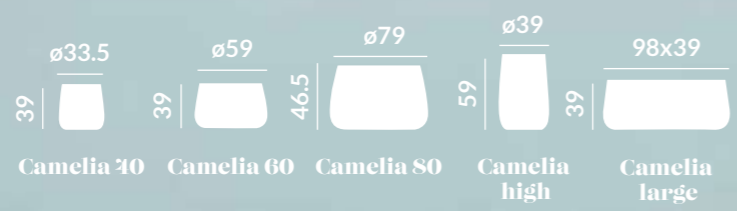

# Camelia





# Palma

## Options

- Light |  Cable  Wireless + Solar ☀️

- Color |

+ Info P. 166



Palma 70



# Hiedra

## Options

- Light |  Cable

- Color |

+ Info P. 162

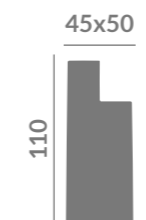

Hiedra







Flowerpots / Gerbera - Violeta

# Gerbera

## Options

- Light  Cable  Wireless + Solar ☀️

- Color

+ Info P. 162

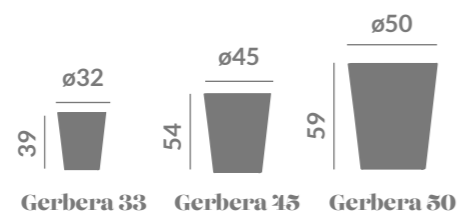

# Violeta

## Options

- Light  Cable  Wireless + Solar ☀️

- Color

+ Info P. 166





TECHNICAL DATA

# 1- PROPERTIES

## 1. Properties

## 2. Plastic finishes and colors

## 3. Maintenance and security recommendations

## 4. Cleaning

## 5. Materials

## 6. Lighting system

## 7. Measurement and references

### . Lighting

- . Floor Lamp
- . Decorative
- . Christmas
- . Portable lamps
- . Table lamps
- . Speakers
- . Wifi
- . Wall
- . Hang
- . Essentials

### . Furniture

- . Tables
- . Seats
- . Bar

### . Flowerpots

## 8. Place a Bulb / Tube

## 9. Play light&music (use mode)

## 10. Bar fixation kit

## 11. Fixation

## 12. Planting system

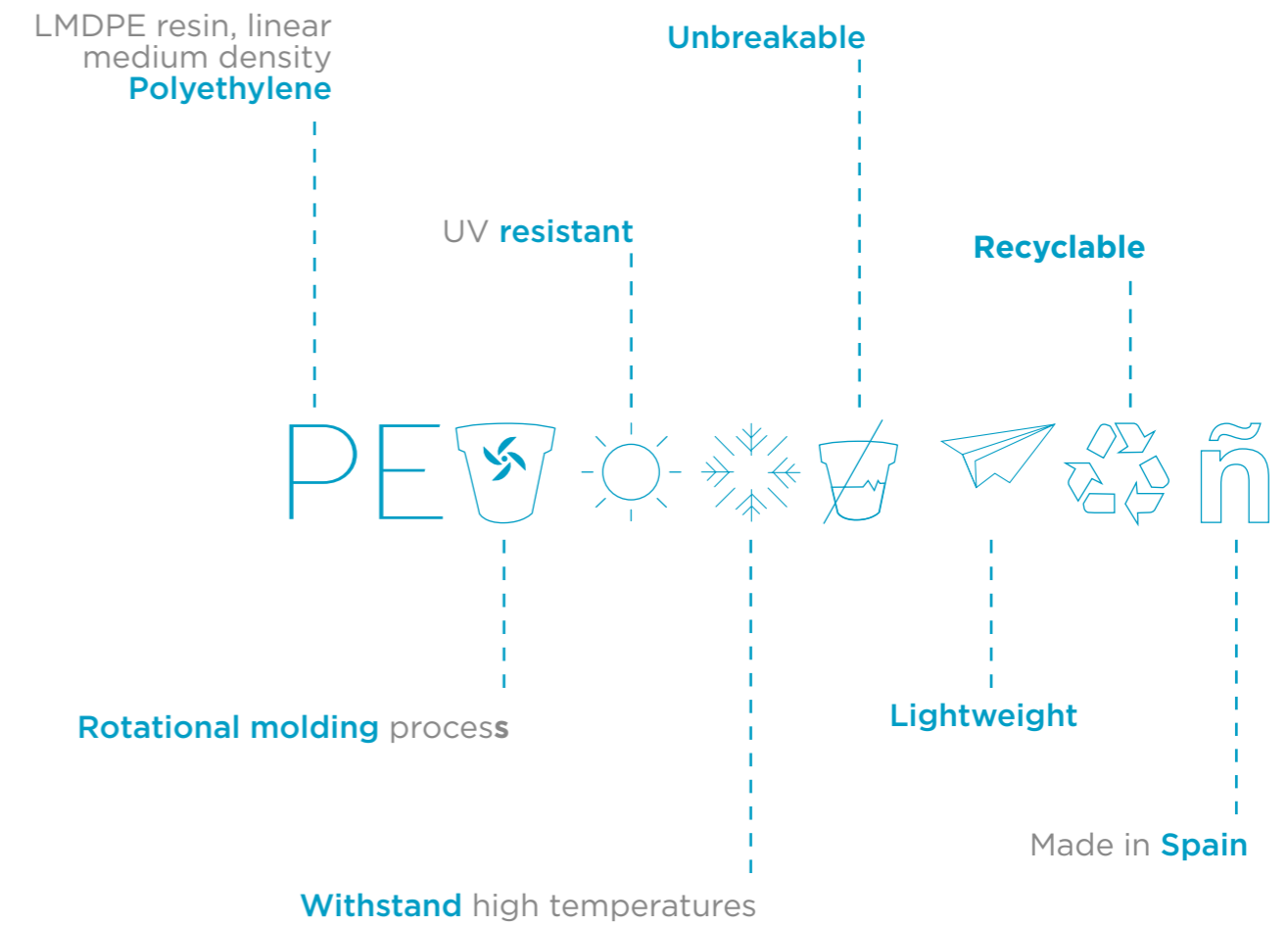

## 2- PLASTIC FINISHES

### TEXTURES

Smooth



Rustic



### TRANSLUCENT COLORS

Translucent white



Translucent lime



Translucent blue



Translucent granite



Translucent green



Translucent pink



### OPAQUE COLORS

White (B)



Bronze (Z)



Soft pink (R)



Black (N)



Grey (S)



Soft blue (C)

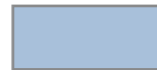

Topo (K)



Terracotta (T)



Soft green (V)



## 3- MAINTENANCE AND SECURITY RECOMMENDATIONS

To ensure safe and enduring performance of our products, please read the following information:

1. Products can cause skin damage due to sun exposure (especially dark colors). Please make sure to check the temperature before using.
2. Place the piece on flat surfaces to prevent unbalanced.
3. Keep away from excessive heat sources
4. This is a decoration, not a toy. Keep away from children.
5. Always unplug before changing the light bulb.
6. Damaged cable should be replaced by the supplier or a qualified professional only.
7. If the LED lighting system does not work, contact the manufacturer for assistance.
8. Connection plugs should have the same degree of protection than outdoor luminaires.
9. Do not use in case of damaged luminaire.
10. Avoid liquid stagnation to preserve sound quality.

## 4- CLEANING

Newgarden products are easy to clean up. Steps to clean the piece:

1. Spray a degreaser product or detergent to clean the surface.
2. Rub with a damp cloth or water.
3. Rinse with abundant water.



[Link to cleaning video demonstration](#)

## 5- MATERIALS

### MATERIAL plastic

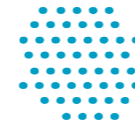

Polyethylene LMDPE

Good physical properties  
Easy Molding  
UV Stabilised  
100% Recyclable  
Outdoor use and indoor use

### MATERIAL Betty



Beech wood

Natural barnish.  
Indoor use and moderated outdoor use

### MATERIAL Rocket / Chloe legs



Beech wood

Natural barnish.  
Outdoor use and indoor use

### MATERIAL phenolic compounds



High pressure laminate

High resistance to external aggressions  
Non-porous surface. Waterproof

### MATERIAL Helga



Painted iron

High resistance to external aggressions  
Outdoor use and indoor use

### WEIGHT



Steel



High resistance to external aggressions

### MATERIAL Rudy



Pine wood

Natural barnish  
Indoor use and moderated outdoor use  
Magnetic connection, no installation required

### MATERIAL methacrylate



High resistance to external aggressions  
Non-porous surface

### MATERIAL vegan leather

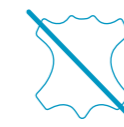

Synthetic leather. Polyurethane

Indoor use and moderated outdoor use

### MATERIAL Fabric



Composition: 80% pvc 18% pes 2% pu

Mlineal weight: 550 g  
Abrasion resistance 25000 martindale cycle  
Light strenght 5/5  
Dry rub fastness 4-5 wet -5  
Tears weave resistance 24.5n/29.4n  
Break weave resistance 588n/784n

### PLASTIC HANDLE Nómada



Polyamide

Fiber glass hardened

### COOLER



Aluminium

Tickness 1.5 mm  
Outdoor use and indoor use

## 6- LIGHTING SYSTEM

### OUTDOOR CABLE



**Outdoor cable**  
2 m / 4 m

Cable: 7 mm Ø  
Length: 2150 mm/4000 mm  
Black

Outdoor cable  
2 m / 4 m

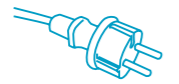

SCHUKO EU



**Outdoor cable**  
3 m

Cable: 7 mm Ø  
Length: 3000 mm  
Black

Outdoor cable  
3 m



USA UK CH

### IN&OUT CABLE



**HEMP cable**

Cable: 8.5 mm Ø  
Length: 2150 mm/4000 mm  
Black

Outdoor cable  
2 m/4m



SCHUKO EU



**HEMP cable**

Cable: 8.5 mm Ø  
Length: 3000 mm  
Black

Outdoor cable  
3 m



USA UK CH

### INDOOR CABLE



**Foot switch**

Cable: 3x5 mm  
Length: 1500+1000 mm  
Footswitch  
Black or transparent

European plug

Foot switch

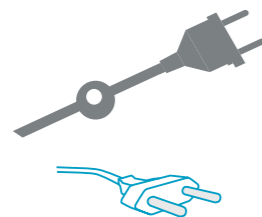

**Hand switch**

Cable: 3x5 mm  
Length: 1200+800 mm  
Hand switch  
Transparent

European plug

Hand switch

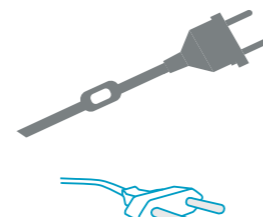

### BULBS



**Cool light**  
6000/6500°K



**Warm light**  
2700-3000°K



**IN&out**  
2700°K / 6500°K

Base E27

**NANO PC**  
9-22 W A+  
85-265VAC  
900-2200 lumens  
48-168 LEDS  
>25.000 hours





**Cool light**  
6000/6500°K

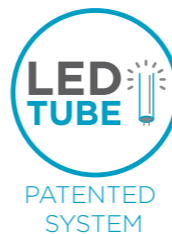

**Warm light**  
2700-3000°K

\*Characteristics may vary depending on future updates or product improvements



## SMARTTECH 2.0 (solar+rechargeable battery)



Night mode / Manual mode



LED technology



128 colours +3 white

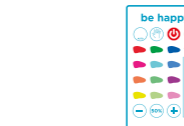

Remote control



Charger



2-6 hours



12-36 hours



Outdoor and indoor



With this mode, the product will automatically turn on when an ideal level of darkness is detected.



With this mode, you can turn the product on and off to your liking.

### Charge vs autonomy



\*Following models have different electrical and solar charge autonomy.



Electric charge autonomy



Solar charge autonomy

BULY 80  
CHLOE  
FITY 100  
FREDO 140  
FREDO 170  
HIEDRA  
KAKTUS  
MAGNOLIA 90  
PANCHE  
PINUS 100  
PINUS 160  
ROCKET  
SNOWY 100

### New remote control



Night mode.



Higher light intensity.

Party mode.



Manual mode.



Lower light intensity.

Flash mode.



Turn Off.



50% intensity of light.

Relax mode.



Turn On.



White light.

Chakras mode.

### Trending colors



SMARTTECH  
FLOATING

Buly 30 and buly 40 are smarttech floating



Outdoor and floating

## PLAY: LIGHT & MUSIC



Bluetooth



LED technology



128 colours +white



Remote control



Charger



4-6 hours



8-12 hours



Protect from humidity. Avoid direct contact with water.

## RECHARGEABLE BATTERY



4-6 hours



8-10 hours  
12-36 hours  
*\*Check model*



LED technology



256 colours+white



Remote control



Charger



Outdoor and indoor

## WALL + HANG



SUITABLE FOR COVERED OUTDOOR AREAS

Bulb not included



## 7- MEASUREMENT AND REFERENCES

Due to the manufacturing process, product dimensions may vary slightly. The dimensions of the packaging can vary due to adjustments in the improvement process.

### LIGHTING

#### FLOOR LAMPS

FITY 100	DIMENSIONS CM	PACKAGING	REFERENCES
	102 Ø20	20.2 102.5 20.2 Weight: 4,7 kg	<p><b>Options</b></p> <ul style="list-style-type: none"> <li>In&amp;out cable / white light* (indoor &amp; outdoor use) — LUMFT100OFNW</li> <li>In&amp;out cable / warm light* (indoor &amp; outdoor use) — LUMFT100OCNW</li> <li>Smarttech (solar + rechargeable battery) — LUMFT100SSNW</li> </ul> <p><i>*LED tube lighting</i></p> <p><b>LED TUBE</b> *Supplied</p> <p><b>IN&amp;out</b></p> <p><b>HEMP</b> Cable</p>
	160 Ø20	20.2 165.5 20.2 Weight: 6,2 kg	<p><b>Options</b></p> <ul style="list-style-type: none"> <li>In&amp;out cable / white light* (indoor &amp; outdoor use) — LUMFT160OFNW</li> <li>In&amp;out cable / warm light* (indoor &amp; outdoor use) — LUMFT160OCNW</li> </ul> <p><i>*LED tube lighting</i></p> <p><b>LED TUBE</b> *Supplied</p> <p><b>IN&amp;out</b></p> <p><b>HEMP</b> Cable</p>
	140 Ø43	25 Ø43 135,5 33 Weight: kg	<p><b>Options</b></p> <ul style="list-style-type: none"> <li>In&amp;out cable / white light* (indoor &amp; outdoor use) — LUMCHL140INOUTNW</li> <li>Indoor cable / warm light* — LUMCHL140ICNW</li> <li>Smarttech (solar + rechargeable battery) — LUMCHL140SSNW</li> </ul> <p><b>*BASE</b></p> <p>Base E27  x 1  *Supplied</p> <p><b>IN&amp;out</b></p> <p><b>HEMP</b> Cable</p>
	70 40 Ø38	37,4 43,5 37,4 Weight: 2,2 kg	<p><b>Options</b></p> <ul style="list-style-type: none"> <li>In&amp;out cable / white light* (indoor &amp; outdoor use) — LUMRCK070INOUTNW</li> <li>Indoor cable / warm light* — LUMRCK070ICNW</li> <li>Smarttech (solar + rechargeable battery) — LUMRCK070SSNW</li> </ul> <p><b>*BASE</b></p> <p>Base E27  x 1  *Supplied</p> <p><b>IN&amp;out</b></p> <p><b>HEMP</b> Cable</p>

**GRACE 140** DIMENSIONS CM

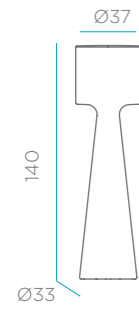

PACKAGING

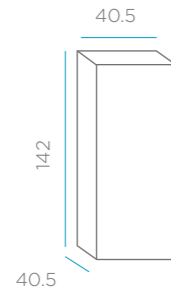

**Options**

- Outdoor cable / white light \* \_\_\_\_\_ LUMGC140OFNW
- Battery \_\_\_\_\_ LUMGC140WLNW

Weight: 5,5 kg  
All finishes // Floor anchorage included.

REFERENCES



**PANCHO** DIMENSIONS CM

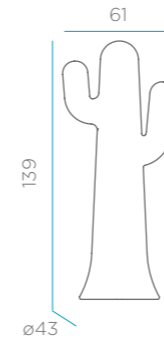

PACKAGING

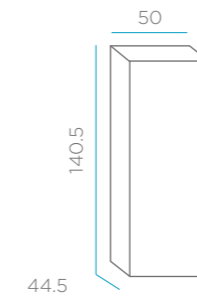

**Options**

- Lime/ Outdoor cable / white light\* \_\_\_\_\_ LUMPV140OFNW
- Outdoor cable / white light \* \_\_\_\_\_ LUMPC140OFNW
- Smarttech (solar + rechargeable battery) \_\_\_\_\_ LUMPC140SSNW

Weight: 6 kg  
All finishes // Floor anchorage included.

REFERENCES



**GRACE 170** DIMENSIONS CM

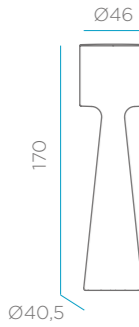

PACKAGING

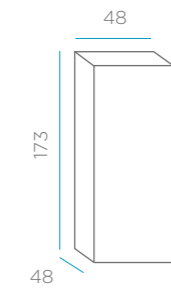

**Options**

- Outdoor cable / white light \* \_\_\_\_\_ LUMGC170OFNW
- Battery \_\_\_\_\_ LUMGC170WLNW

Weight: 7,6 kg  
All finishes // Floor anchorage included.

REFERENCES



**LOLA 110** DIMENSIONS CM



PACKAGING

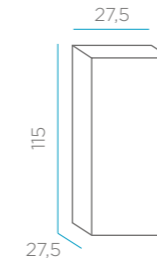

**Options**

- Outdoor cable / white light \* \_\_\_\_\_ LUMLL110OFNW
- Indoor cable / warm light\* \_\_\_\_\_ LUMLL110ICNW
- Battery \_\_\_\_\_ LUMLL110WLNW

Weight: 3,5 kg  
All finishes // Floor anchorage included.

REFERENCES



**LOLA SLIM** DIMENSIONS CM

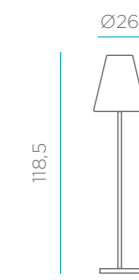

PACKAGING

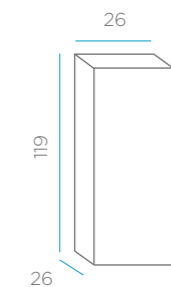

**Options**

- Outdoor white\* \_\_\_\_\_ LUMLL120FCNW

**\*BASE**

Base E27 x 1 \*Supplied

REFERENCES

**LOLA 165** DIMENSIONS CM

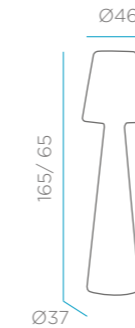

PACKAGING

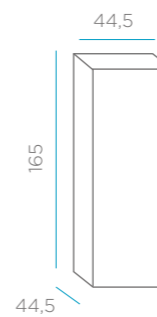

**Options**

- Outdoor cable / white light \* \_\_\_\_\_ LUMLL165OFNW
- Indoor cable / warm light\* \_\_\_\_\_ LUMLL165ICNW
- Battery \_\_\_\_\_ LUMLL165WLNW

Weight: 10,5 kg  
All finishes // Floor anchorage included.

REFERENCES



**KAKTUS** DIMENSIONS CM

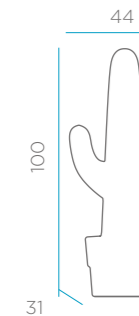

PACKAGING

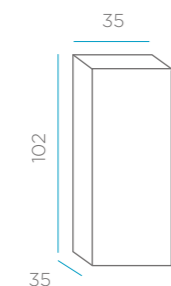

**Options**

- Lime/ Outdoor cable / white light\* \_\_\_\_\_ LUMKL100OFNW
- Outdoor cable / white light \* \_\_\_\_\_ LUMKL100OFNW
- Smarttech (solar + rechargeable battery) \_\_\_\_\_ LUMKL100SSNW

Weight: 3,2 kg  
All finishes // Floor anchorage included.

REFERENCES



**LOLA 200** DIMENSIONS CM

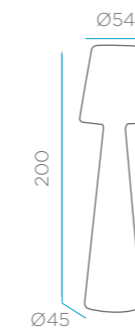

PACKAGING

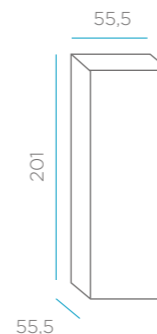

**Options**

- Outdoor cable / white light \* \_\_\_\_\_ LUMLL200FNW
- Indoor cable / warm light\* \_\_\_\_\_ LUMLL200ICNW

Weight: 12,5 kg  
All finishes // Floor anchorage included.

REFERENCES



**HELGA** DIMENSIONS CM

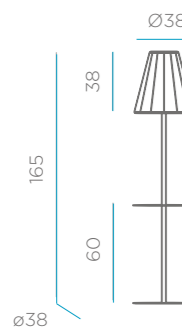

PACKAGING

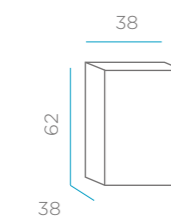

**Options**

- Smarttech (solar + rechargeable battery)+ USB \_\_\_\_\_ LUMHLA165SSNW
- Smarttech (solar + rechargeable battery)+ USB \_\_\_\_\_ LUMHLR165SSNW
- Smarttech (solar + rechargeable battery)+ USB \_\_\_\_\_ LUMHLV165SSNW



Weight: 10 kg

REFERENCES

**CARMEN 110** DIMENSIONS CM

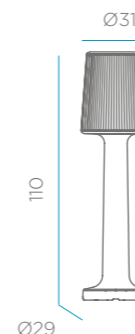

PACKAGING

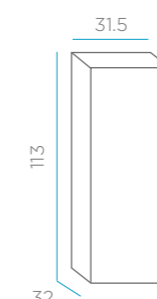

**Options**

- Outdoor cable / white light \* \_\_\_\_\_ LUMCR110OFNW
- Indoor cable / warm light\* \_\_\_\_\_ LUMCR110ICNW
- Battery \_\_\_\_\_ LUMCR110WLNW

Weight: 4,5 kg  
All finishes // Floor anchorage included.

REFERENCES

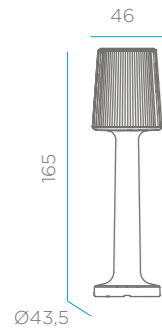

**CARMEN 165** DIMENSIONS CM

## PACKAGING

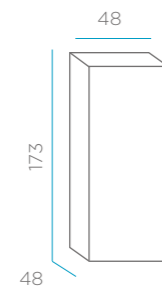

Weight: 8,5 kg

All finishes // Floor anchorage included.

- Options**
- Outdoor cable / white light\* — LUMCR165OFNW
  - Indoor cable / warm light\* — LUMCR165ICNW
  - Battery — LUMCR165WLNW

## REFERENCES

**GOA 40** DIMENSIONS CM

## PACKAGING

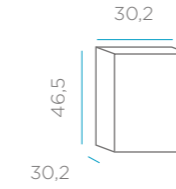

Weight: 1,5 kg

- Options**
- Outdoor cable / white light\* — LUMGA040OFNW
  - Smarttech (solar + rechargeable battery) — LUMGA040SSNW

**\*BASE**

Base E27



x 1



\*Supplied

## REFERENCES

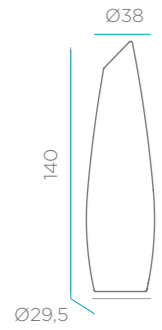
**FREDO 140** DIMENSIONS CM

## PACKAGING

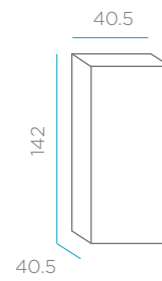

Weight: 5 kg

All finishes // Floor anchorage included.

- Options**
- Outdoor cable / white light\* — LUMFD140OFNW
  - Smarttech (solar + rechargeable battery) — LUMFD140SSNW

## REFERENCES

**GOA 70** DIMENSIONS CM

## PACKAGING

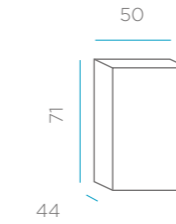

Weight: 5,7 kg

- Options**
- Outdoor cable / white light\* — LUMGA070OFNW
  - Smarttech (solar + rechargeable battery) — LUMGA070SSNW

**\*BASE**

Base E27



x 1



\*Supplied

## REFERENCES

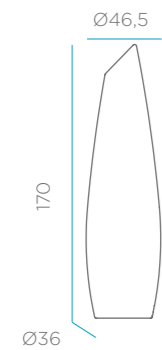
**FREDO 170** DIMENSIONS CM

## PACKAGING

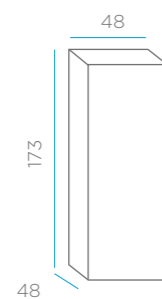

Weight: 7,5 kg

Outdoor white // Weight stability included

- Options**
- Outdoor cable / white light\* — LUMFD170OFNW
  - Outdoor cable / warm light\* — LUMFD170ICNW
  - Smarttech (solar + rechargeable battery) — LUMFD170SSNW

## REFERENCES

**GUFO 40** DIMENSIONS CM

## PACKAGING

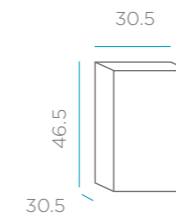

Weight: 2 kg

- Options**
- Outdoor cable / white light\* — LUMGF040OFNW
  - Smarttech (solar + rechargeable battery) — LUMGF040SSNW

**\*BASE**

Base E27



x 1



\*Supplied

## REFERENCES

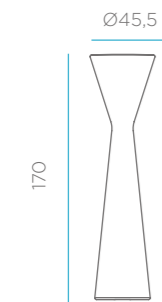
**KONIKA 170** DIMENSIONS CM

## PACKAGING

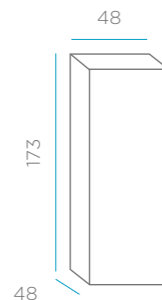

Weight: 7,5 kg

All finishes // Floor anchorage included.

- Options**
- Outdoor cable / white light\* — LUMKNI170OFNW
  - Battery — LUMKNI170WLNW

## REFERENCES

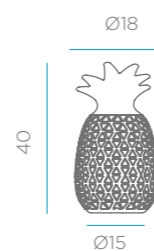
**SAMBA** DIMENSIONS CM

## PACKAGING

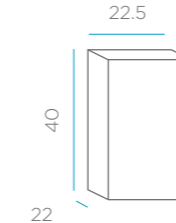

Weight: 0,5 kg

- Options**
- Lime / Indoor cable / warm light\* — LUMSMLV40ICNW
  - Indoor cable / warm light\* — LUMSMV40ICNW
  - Battery — LUMSMO40WLNW

**\*BASE**

Base E27



x 1



\*Supplied

## REFERENCES

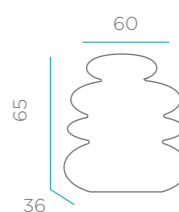
**DECORATIVE****BALANS** DIMENSIONS CM

## PACKAGING

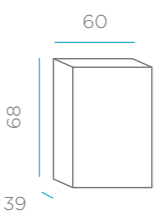

Weight: 4,5 kg

- Options**
- Outdoor cable / white light\* — LUMBS070OFNW
  - Smarttech (solar + rechargeable battery) — LUMBS070SSNW

## REFERENCES

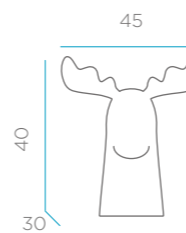
**RUDY** DIMENSIONS CM

## PACKAGING

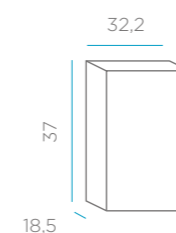

Weight: 1,4 kg

- Options**
- Indoor cable / warm light\* — LUMRD035ICNW
  - Smarttech (solar + rechargeable battery) — LUMRD035SSNW

**\*BASE**

Base E27



x 1



\*Supplied

## REFERENCES



**AMELIO**

DIMENSIONS CM



PACKAGING

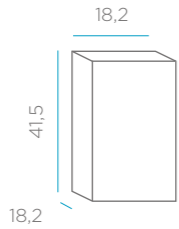

Weight: 1,1 kg

**Options**

- Indoor cable / warm light\* \_\_\_\_\_ LUMAM040ICNW
- Smarttech (solar + rechargeable battery) \_\_\_\_\_ LUMAM040SSNW

**\*BASE**

Base E27



x 1



\*Supplied

REFERENCES



**CHRISTMAS**

**PINUS 40**

DIMENSIONS CM

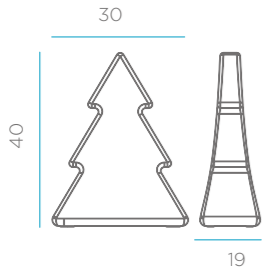

PACKAGING

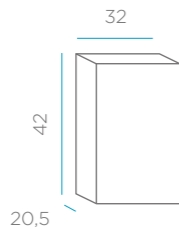

Weight: 1,3 kg

**Options**

- Green / Indoor cable / warm light\* \_\_\_\_\_ LUMPNV040ICNW
- Indoor cable / warm light\* \_\_\_\_\_ LUMPNO40ICNW
- Smarttech (solar + rechargeable battery) \_\_\_\_\_ LUMPNO40SSNW

**\*BASE**

Base E27



x 1



\*Supplied

REFERENCES



**SNOWY 100**

DIMENSIONS CM

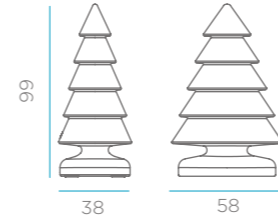

PACKAGING

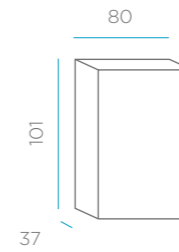

Weight: 5,1 kg

**Options**

- Outdoor cable / white light\* \_\_\_\_\_ LUMSN1000FNW
- Smarttech (solar + rechargeable battery) \_\_\_\_\_ LUMSN100SSNW



**NOVA 45**

DIMENSIONS CM

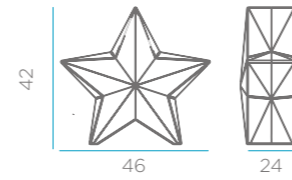

PACKAGING

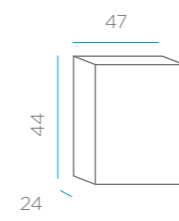

Weight: 1,9 kg

**Options**

- Indoor cable / warm light\* \_\_\_\_\_ LUMNV045ICNW
- Smarttech (solar + rechargeable battery) \_\_\_\_\_ LUMNV045SSNW

**\*BASE**

Base E27



x 1



\*Supplied

REFERENCES

**NOVA 60**

DIMENSIONS CM

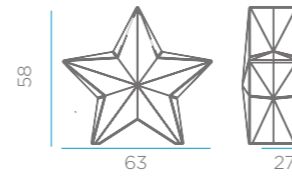

PACKAGING

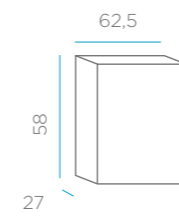

Weight: 3,2 kg

**Options**

- Outdoor cable / white light\* \_\_\_\_\_ LUMNV0600FNW
- Indoor cable / warm light\* \_\_\_\_\_ LUMNV060ICNW
- Smarttech (solar + rechargeable battery) \_\_\_\_\_ LUMNV060SSNW

**\*BASE**

Base E27



x 1



\*Supplied

REFERENCES

**PINUS 100**

DIMENSIONS CM

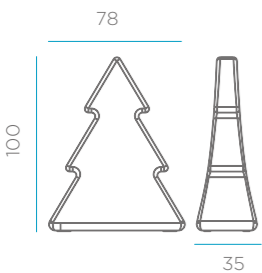

PACKAGING

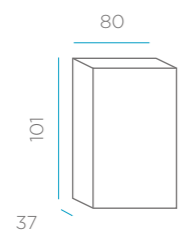

Weight: 5,5 kg

**Options**

- Outdoor cable / white light\* \_\_\_\_\_ LUMPNI000FNW
- Indoor cable / warm light\* \_\_\_\_\_ LUMPNI000CNW
- Green / Indoor cable / warm light\* \_\_\_\_\_ LUMPNI000CNW
- Smarttech (solar + rechargeable battery) \_\_\_\_\_ LUMPNI000SSNW



**PINUS 160**

DIMENSIONS CM

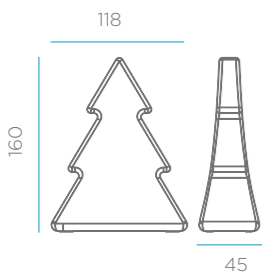

PACKAGING

Plastic bag  
Weight: 14 kg

**Options**

- Outdoor cable / white light\* \_\_\_\_\_ LUMPNI600FNW
- Outdoor cable / warm light\* \_\_\_\_\_ LUMPNI600CNW
- Green outdoor white\* \_\_\_\_\_ LUMPNI600FNW
- Smarttech (solar + rechargeable battery) \_\_\_\_\_ LUMPNI600SSNW



**KLAUS**

DIMENSIONS CM

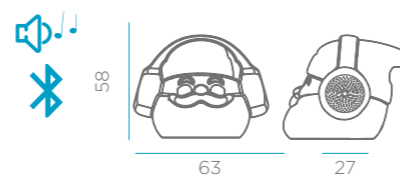

PACKAGING

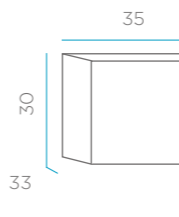

Weight: 1,8 kg

**Options**

- Play light&music \_\_\_\_\_ LUMKS030PLNW



**PORTABLE LAMPS**

**NORAI**

DIMENSIONS CM

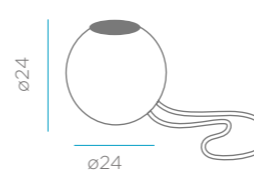

PACKAGING

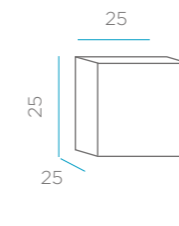

Weight: 1 Kg

**Options**

- Battery (Space grey rope) \_\_\_\_\_ LUMNR025WLNW
- Battery (Pink rope) \_\_\_\_\_ LUMNRR025WLNW
- Battery (Beige rope) \_\_\_\_\_ LUMNRB025WLNW

**norai string**

1,5 mt

REFERENCES

**CANDELA** DIMENSIONS CM PACKAGING REFERENCES

Options Outdoor cable / white light \* \_\_\_\_\_ LUMCN030FNNW   
 Battery \_\_\_\_\_ LUMCN030WLNW

**\*BASE**  
 Base E27 x 1 \*Supplied

Vegan leather handle

30  
 ø20  
 20  
 31  
 Weight: 1,5 Kg

**LOLA 30** DIMENSIONS CM PACKAGING REFERENCES

Options Outdoor cable / white light \* \_\_\_\_\_ LUMLL030FNNW   
 Indoor cable / warm light\* \_\_\_\_\_ LUMLL030ICNW   
 Battery \_\_\_\_\_ LUMLL030WLNW

**\*BASE**  
 Base E27 x 1 \*Supplied

32  
 ø15,5  
 17,5  
 31,5  
 Weight: 1,2 Kg

**NÓMADA** DIMENSIONS CM PACKAGING REFERENCES

Options Smarttech (solar + rechargeable battery) \_\_\_\_\_ LUMNM032SSNW

Plastic handle

30  
 ø20  
 20  
 31  
 Weight: 1,2 Kg

**LOLA 45** DIMENSIONS CM PACKAGING REFERENCES

Options Outdoor cable / white light \* \_\_\_\_\_ LUMLL045FNNW   
 Indoor cable / warm light\* \_\_\_\_\_ LUMLL045ICNW   
 Battery \_\_\_\_\_ LUMLL045WLNW

**\*BASE**  
 Base E27 x 1 \*Supplied

45  
 ø25  
 26  
 48  
 Weight: 1,7 Kg

**FARALAY** DIMENSIONS CM PACKAGING REFERENCES

Options Smarttech (solar + rechargeable battery) \_\_\_\_\_ LUMFA033SSNW

Vegan leather handle

39 /  
 21  
 27,6  
 33  
 Weight: 0,8 kg

**CARMEN 45** DIMENSIONS CM PACKAGING REFERENCES

Options Outdoor cable / white light \* \_\_\_\_\_ LUMCR045FNNW   
 Indoor cable / warm light\* \_\_\_\_\_ LUMCR045ICNW   
 Battery \_\_\_\_\_ LUMCR045WLNW

**\*BASE**  
 Base E27 x 1 \*Supplied

45  
 ø29  
 30,2  
 46,5  
 Weight: 2,3 Kg

**KURBY** DIMENSIONS CM PACKAGING REFERENCES

Options Smarttech (solar + rechargeable battery) \_\_\_\_\_ LUMKR038SSNW

Vegan leather handle

37  
 ø27,5  
 30,2  
 46,5  
 Weight: 1,2 kg

**MAFALDA** DIMENSIONS CM PACKAGING REFERENCES

Options Indoor cable / warm light\* \_\_\_\_\_ LUMMF030ICNW   
 Battery \_\_\_\_\_ LUMMF030WLNW

**\*BASE**  
 Base E27 x 1 \*Supplied

ø22  
 30  
 ø15,5  
 27,6  
 33  
 Weight: 1,2kg

**TABLE LAMPS**

**LOLA 20** DIMENSIONS CM PACKAGING REFERENCES

Options Battery \_\_\_\_\_ LUMLL20WLNW   
 AAA batteries\* \_\_\_\_\_ LUMLL20AAANW

\*no incluidas  
 \*no supplied

20  
 ø10  
 11,7  
 21,4  
 Weight: 0,3 Kg

**SPEAKERS**

**PIPA** DIMENSIONS CM PACKAGING REFERENCES

Options Play light&music \_\_\_\_\_ LUMPP035PLNW

x 1

35  
 18  
 19  
 20,5  
 36  
 20  
 Weight: 1,3 kg

**NIPPER** DIMENSIONS CM PACKAGING REFERENCES

Options Play light&music LUMNP040PLNW x 1

Weight: 1,5 kg

**CUBY 20 PLAY** DIMENSIONS CM PACKAGING REFERENCES

Options Play light&music LUMCBP20WLNW x 2

Weight: 1,1 Kg

**ROBIN PLAY** DIMENSIONS CM PACKAGING REFERENCES

Options Play light&music MOBRB035PLNW x 2

Weight: 2,5 kg

**CUBY 32 PLAY** DIMENSIONS CM PACKAGING REFERENCES

Options Play light&music LUMCBP20WLNW x 2

Weight: 3,1 Kg

**FARALAY PLAY** DIMENSIONS CM PACKAGING REFERENCES

Options Play light&music LUMFA033PLNW x 1

Weight: 0,8 kg

Vegan leather handle

**CUBY 45 PLAY** DIMENSIONS CM PACKAGING REFERENCES

Options Play light&music LUMCBP45WLNW x 2

Weight: 5,35 Kg

**WIFI**

**NÓMADA PLAY** DIMENSIONS CM PACKAGING REFERENCES

Options Play light&music LUMNMO32PLNW x 1

Weight: 1,5 Kg

Plastic handle

**CUBY 45 WiFi** DIMENSIONS CM PACKAGING REFERENCES

Options WiFi outdoor + RGB bulb LUMCBW45OLNW

Weight: 5,35 kg

\*BASE Base E27 x 1 \*Supplied

**KURBY PLAY** DIMENSIONS CM PACKAGING REFERENCES

Options Play light&music LUMKRO38PLNW x 1

Weight: 1,2 kg

Vegan leather handle

**CUBY 20 WALL** DIMENSIONS CM PACKAGING REFERENCES

Options Wall\* LUMCB020OPNW

Weight: 1,6 kg

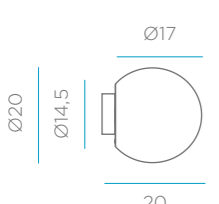

\*BASE Base E27 x 1 Not supplied

**BULY 20 WALL**

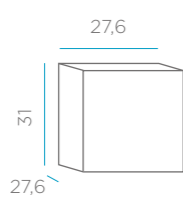
**DIMENSIONS CM**  

**PACKAGING**  
 Weight: 1 kg

**REFERENCES**  
**Options** Wall\* \_\_\_\_\_ LUMBL020OPNW

**\*BASE**  
 Base E27  x 1  Not supplied

**BULY30 HANG**

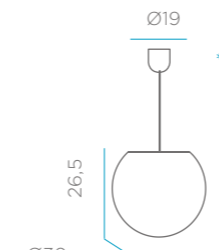
**DIMENSIONS CM**  

**PACKAGING**  
 Weight: 1,6 kg

**REFERENCES**  
**Options** Hang \_\_\_\_\_ LUMBL030HXNW

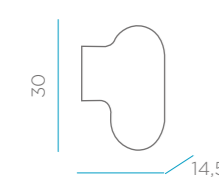

**BASE**  
 Base E27  x 1  \*Not supplied

**CÁPSULA TERPE**

**DIMENSIONS CM**  

**PACKAGING**  
 Weight: 1,6 kg

**REFERENCES**  
**Options** Wall\* \_\_\_\_\_ LUMCP030OPNW

**\*BASE**  
 Base E27  x 1  Not supplied

**PETRA40 HANG**

**DIMENSIONS CM**  



**PACKAGING**  
 Weight: 1,5 kg

**REFERENCES**  
**Options** Hang \_\_\_\_\_ LUMPT040HXNW

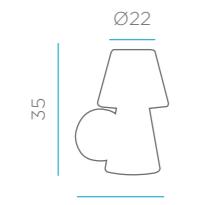

**BASE**  
 Base E27  x 1  \*Not supplied

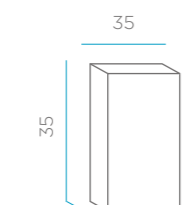
**LOLA WALL**

**DIMENSIONS CM**  

**PACKAGING**  
 Weight: 1,6 kg

**REFERENCES**  
**Options** Wall\* \_\_\_\_\_ LUMLL035OPNW

**\*BASE**  
 Base E27  x 1  Not supplied

**PETRA60 HANG**

**DIMENSIONS CM**  



**PACKAGING**  
 Weight: 3,2 kg

**REFERENCE**  
**Options** Hang \_\_\_\_\_ LUMPT060HXNW

**BASE**  
 Base E27  x 1  \*Not supplied

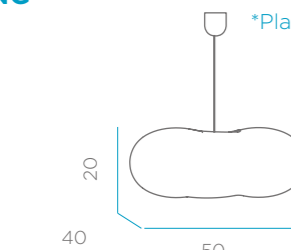

**HANG**

**CLAUDY HANG**

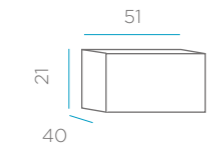
**DIMENSIONS CM**  

**PACKAGING**  
 Weight: 2,3 kg

**REFERENCES**  
**Options** Hang white color \_\_\_\_\_ LUMCL050HXNW ○  
 Hang soft pink \_\_\_\_\_ LUMCLR50HXNW ●  
 Hang soft blue \_\_\_\_\_ LUMCLA50HXNW ●

**BASE**  
 Base E27  x 1  \*Not supplied

**ESSENTIALS**

**BULY 20**

**DIMENSIONS CM**  



**PACKAGING**  
 Weight: 0,8 kg

**REFERENCES**  
**Options** Outdoor cable / white light \* \_\_\_\_\_ LUMBL020OFNW   
 Smarttech (solar + rechargeable battery) \_\_\_\_\_ LUMBL020SSNW 

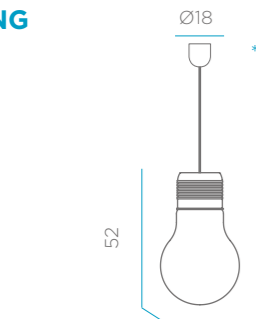

**\*BASE**  
 Base E27  x 1  \*Supplied

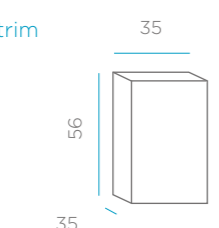
**BALBY HANG**

**DIMENSIONS CM**  

**PACKAGING**  
 Weight: 2,5 kg





**REFERENCES**  
**Options** Hang \_\_\_\_\_ LUMBBO30HXNW

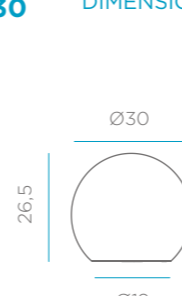

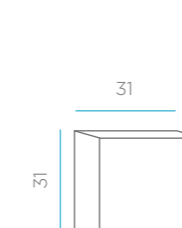
**BASE**  
 Base E27  x 1  \*Not supplied

**BULY 30**

**DIMENSIONS CM**  

**PACKAGING**  
 Weight: 0,7 kg

**REFERENCES**  
**Options** Outdoor cable / white light \* \_\_\_\_\_ LUMBL030OFNW   
 Smarttech (solar + rechargeable battery) \_\_\_\_\_ LUMBL030SSNW   
 Smarttech Floating (solar + rechargeable battery) \_\_\_\_\_ LUMBL030FTNW   
 Outdoor white granite\* \_\_\_\_\_ LUMBLG30OFNW 

**\*BASE**  
 Base E27  x 1  \*Supplied

**BULY 40** DIMENSIONS CM PACKAGING REFERENCES

Options  
 Outdoor cable / white light \* \_\_\_\_\_ LUMBL040OFNW  
 Smarttech (solar + rechargeable battery) \_\_\_\_\_ LUMBL040SSNW  
 Smarttech Floating (solar + rechargeable battery) \_\_\_\_\_ LUMBL040FTNW

Weight: 1,8 kg

**\*BASE**  
 Base E27 x 1 \*Supplied

**CUBY 32** DIMENSIONS CM PACKAGING REFERENCES

Options  
 Outdoor cable / white light \* \_\_\_\_\_ LUMCB032OFNW  
 Smarttech (solar + rechargeable battery) \_\_\_\_\_ LUMCB032SSNW

Weight: 2,7 kg

**\*BASE**  
 Base E27 x 1 \*Supplied

**BULY 50** DIMENSIONS CM PACKAGING REFERENCES

Options  
 Outdoor cable / white light \* \_\_\_\_\_ LUMBL050OFNW  
 Smarttech (solar + rechargeable battery) \_\_\_\_\_ LUMBL050SSNW

Weight: 3 kg

**\*BASE**  
 Base E27 x 1 \*Supplied

**CUBY 45** DIMENSIONS CM PACKAGING REFERENCES

Options  
 Outdoor cable / white light \* \_\_\_\_\_ LUMCB045OFNW  
 Smarttech (solar + rechargeable battery) \_\_\_\_\_ LUMCB045SSNW

Weight: 5 kg

**\*BASE**  
 Base E27 x 1 \*Supplied

**BULY 60** DIMENSIONS CM PACKAGING REFERENCES

Options  
 Outdoor cable / white light \* \_\_\_\_\_ LUMBL060OFNW  
 Smarttech (solar + rechargeable battery) \_\_\_\_\_ LUMBL060SSNW

Weight: 4,5 kg

**\*BASE**  
 Base E27 x 1 \*Supplied

**CUBY 53** DIMENSIONS CM PACKAGING REFERENCES

Options  
 Outdoor cable / white light \* \_\_\_\_\_ LUMCB053OFNW  
 Smarttech (solar + rechargeable battery) \_\_\_\_\_ LUMCB053SSNW

Weight: 5,5 kg

**\*BASE**  
 Base E27 x 1 \*Supplied

**BULY 80** DIMENSIONS CM PACKAGING REFERENCES

Options  
 Outdoor cable / white light \* \_\_\_\_\_ LUMBL080OFNW  
 Smarttech (solar + rechargeable battery) \_\_\_\_\_ LUMBL080SSNW

Weight: 9,5 kg

**\*BASE**  
 Base E27 x 1 \*Supplied

**PETRA 40** DIMENSIONS CM PACKAGING REFERENCES

Options  
 Outdoor cable / white light \* \_\_\_\_\_ LUMPT040OFNW  
 Smarttech (solar + rechargeable battery) \_\_\_\_\_ LUMPT040SSNW

Weight: 0,8 kg

**\*BASE**  
 Base E27 x 1 \*Supplied

**CUBY 20** DIMENSIONS CM PACKAGING REFERENCES

Options  
 Outdoor cable / white light \* \_\_\_\_\_ LUMCB020OFNW  
 Smarttech (solar + rechargeable battery) \_\_\_\_\_ LUMCB020SSNW

Weight: 1,1 kg

**\*BASE**  
 Base E27 x 1 \*Supplied

**PETRA 60** DIMENSIONS CM PACKAGING REFERENCES

Options  
 Outdoor cable / white light \* \_\_\_\_\_ LUMPT060OFNW  
 Smarttech (solar + rechargeable battery) \_\_\_\_\_ LUMPT060SSNW

Weight: 2,5kg

**\*BASE**  
 Base E27 x 1 \*Supplied

# FURNITURE

## TABLES

**BAHAMA** DIMENSIONS CM PACKAGING REFERENCES

Options

- Smarttech (solar + rechargeable battery) LUMBH110SSNW
- White color LUMBH110BXNW
- Black color MOB BH110NXNW

Weight: 10,5 kg  
Methacrylate cover included

**CAPRI 40** DIMENSIONS CM PACKAGING REFERENCES

Options

- Smarttech (solar + rechargeable) MOB CP040SSNW
- White color MOB CP040BXNW
- Bronze color MOB CP040ZXNW
- Topo color MOB CP040KXNW
- Black color MOB CP040NXNW

Weight: 4,5 kg  
Methacrylate cover included

**CAPRI 75** DIMENSIONS CM PACKAGING REFERENCES

Options

- Smarttech (solar + rechargeable) MOB CP075SSNW
- Outdoor cable / white light \* MOB CP075OFNW
- White color MOB CP075BXNW
- Bronze color MOB CP075ZXNW
- Topo color MOB CP075KXNW

Plastic bag  
Weight: 18 kg  
Methacrylate cover included

**\*BASE**  
Base E27 x 1 \*Supplied

**CAPRI 110** DIMENSIONS CM PACKAGING REFERENCES

Options

- Smarttech (solar + rechargeable) MOB CP110SSNW
- Outdoor cable / white light \* MOB CP110OFNW
- White color MOB CP110BXNW
- Bronze color MOB CP110ZXNW
- Topo color MOB CP110KXNW

Weight: 10 kg  
Methacrylate cover included

**\*BASE**  
Base E27 x 1 \*Supplied

**MELVIN** DIMENSIONS CM PACKAGING REFERENCES

Options

- Smarttech (solar + rechargeable) MOB MV055SSNW
- White color MOB MV055BXNW
- Bronze color MOB MV055ZXNW
- Topo color MOB IMV055KXNW

Weight: 6 kg  
Methacrylate cover included

**MARTINICA NEW ISLAND** DIMENSIONS CM PACKAGING REFERENCES

Options

- Smarttech (solar + rechargeable) MOB MESMASSNW
- White color MOB MESMABXNW
- Bronze color MOB MESMAZXNW
- Topo color MOB IMESMAKXNW

Plastic bag  
Weight: 10 kg

**TARIDA TAB** DIMENSIONS CM PACKAGING REFERENCES

Options

- Play light&music MOB TDT30PLNW
- Smarttech (solar + rechargeable) MOB TDT30SSNW
- Black color MOB TDT30BXNW
- Bronze color MOB TDT30ZXNW
- Topo color MOB TDT30KXNW

Plastic bag  
Weight: 5 kg  
Methacrylate cover included

**ITACA** DIMENSIONS CM PACKAGING REFERENCES

Options

- Smarttech (solar + rechargeable) MOB ITC60SSNW
- White color MOB ITC60BXNW
- Bronze color MOB ITC60CZXNW
- Topo color MOB ITC60CKXNW

Weight: 14 kg  
Phenolic cover included. Unassembled  
Weight stability included  
Individual package. tabletop plastic bag

**CUBY 45** DIMENSIONS CM PACKAGING REFERENCES

Options

- Outdoor cable / white light \* LUM CB045OFNW
- Smarttech (solar + rechargeable battery) LUM CB045SSNW

Weight: 5 kg

**\*BASE**  
Base E27 x 1 \*Supplied

**CUBY 53** DIMENSIONS CM PACKAGING REFERENCES

Options

- Outdoor cable / white light \* LUM CB053OFNW
- Smarttech (solar + rechargeable battery) LUM CB053SSNW

Weight: 5,5 kg

**\*BASE**  
Base E27 x 1 \*Supplied

### CUBY 53 PLAY

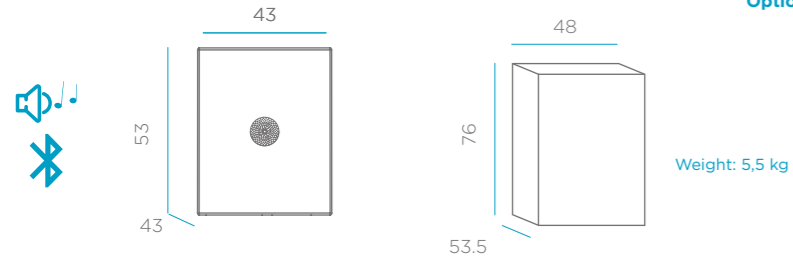

**Options**

- Play light&music \_\_\_\_\_ LUMCBP53WLNW
- Speaker icon x 2

### REFERENCES

### TARIDA SIT

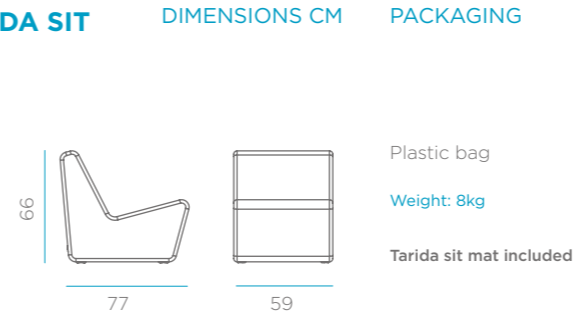

**Options**

- Smarttech (solar + rechargeable battery) \_\_\_\_\_ MOBTD566SSNW
- White color \_\_\_\_\_ MOBTD566BXNW
- Bronze color \_\_\_\_\_ MOBTD566ZXNW
- Topo color \_\_\_\_\_ MOBTD566KXNW
- Soft pink color \_\_\_\_\_ MOBTD566RSNW

### REFERENCES

### BETTY USB

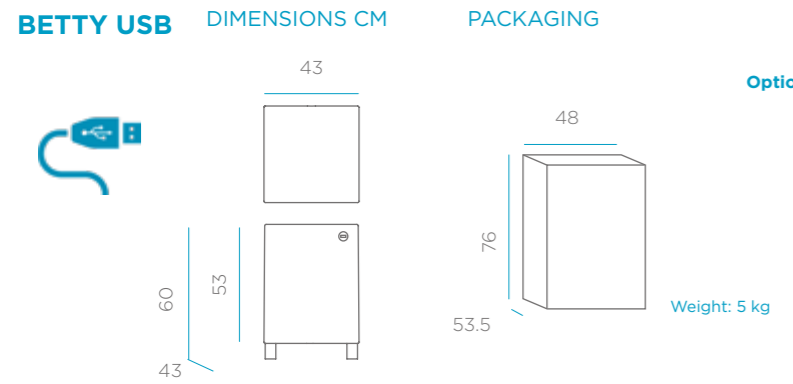

**Options**

- Indoor cable / warm light \_\_\_\_\_ MOBBT060IUNW

### REFERENCES

**\*BASE**

Base E27

 x 1 \*Supplied

### MALLORCA

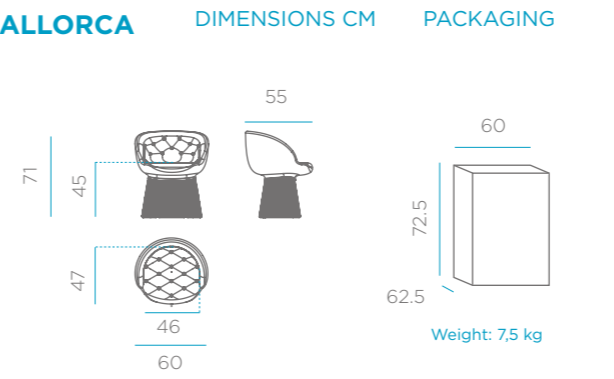

**Options**

- Smarttech (solar + rechargeable battery) \_\_\_\_\_ MOBMA060SSNW
- White color \_\_\_\_\_ MOBMA060BXNW
- Bronze color \_\_\_\_\_ MOBMA060ZXNW
- Topo color \_\_\_\_\_ MOBMA060KXNW

### REFERENCES

## SEATS

### FORMENTERA

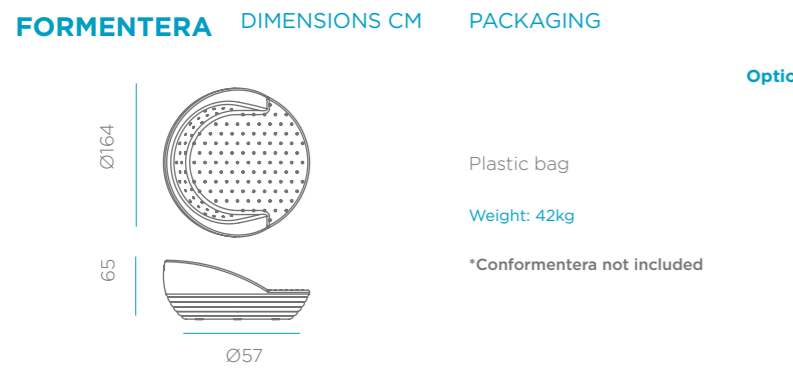

**Options**

- Smarttech (solar + rechargeable battery) \_\_\_\_\_ MOBFR160SSNW
- Outdoor cable / white light \* \_\_\_\_\_ MOBFR160FNNW
- White color \_\_\_\_\_ MOBFR160BXNW
- Topo color \_\_\_\_\_ MOBFR160KXNW

### REFERENCES

**\*BASE**

Base E27

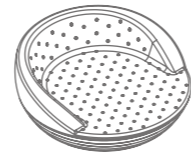
 x 2 \*Supplied

### MENORCA BENCH

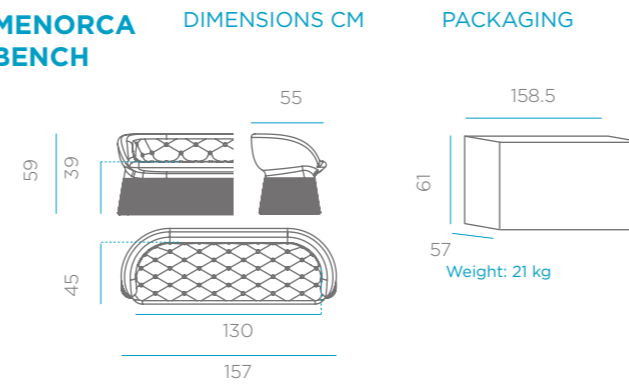

**Options**

- Smarttech (solar + rechargeable battery) \_\_\_\_\_ MOBME150SSNW
- Outdoor cable / white light \* \_\_\_\_\_ MOBME150FNNW
- White color \_\_\_\_\_ MOBME150BXNW
- Bronze color \_\_\_\_\_ MOBME150ZXNW
- Topo color \_\_\_\_\_ MOBME150KXNW

### REFERENCES

**\*BASE**

Base E27

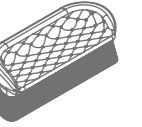
 x 2 \*Supplied

### ARUBA NEW ISLAND

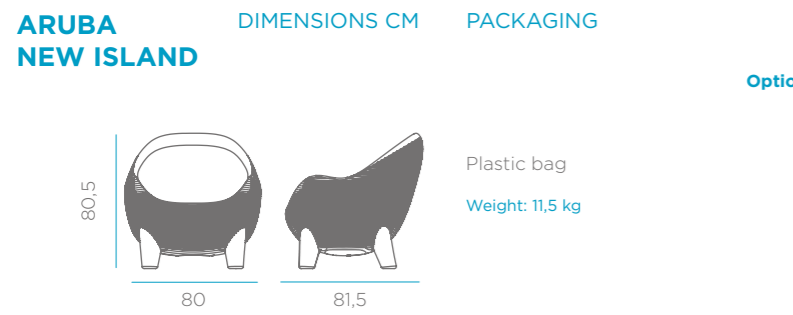

**Options**

- Smarttech (solar + rechargeable battery) \_\_\_\_\_ MOBSILARSSNW
- White color \_\_\_\_\_ MOBSILARBXNW
- Bronze color \_\_\_\_\_ MOBSILARZXNW
- Topo color \_\_\_\_\_ MOBSILARKXNW

### REFERENCES



### MENORCA SOFA

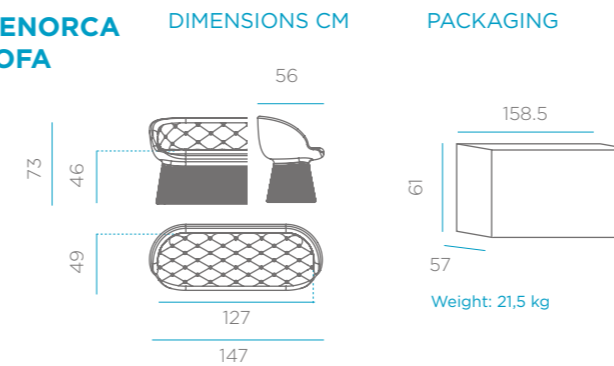

**Options**

- Smarttech (solar + rechargeable battery) \_\_\_\_\_ MOBMS150SSNW
- Outdoor cable / white light \* \_\_\_\_\_ MOBMS150FNNW
- White color \_\_\_\_\_ MOBMS150BXNW
- Bronze color \_\_\_\_\_ MOBMS150ZXNW
- Topo color \_\_\_\_\_ MOBMS150KXNW

### REFERENCES

**\*BASE**

Base E27

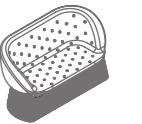
 x 2 \*Supplied

### JAMAICA NEW ISLAND

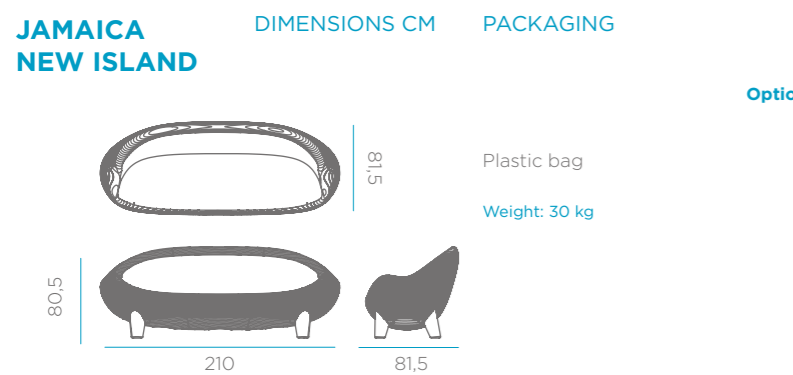

**Options**

- Smarttech (solar + rechargeable battery) \_\_\_\_\_ MOB50FJASSNW
- Outdoor cable / white light \* \_\_\_\_\_ MOB50FJAFNNW
- White color \_\_\_\_\_ MOB50FJABXNW
- Bronze color \_\_\_\_\_ MOB50FJAZXNW
- Topo color \_\_\_\_\_ MOB50FJAKXNW

### REFERENCES

**\*BASE**

Base E27

 x 1 \*Supplied

### CALVIN

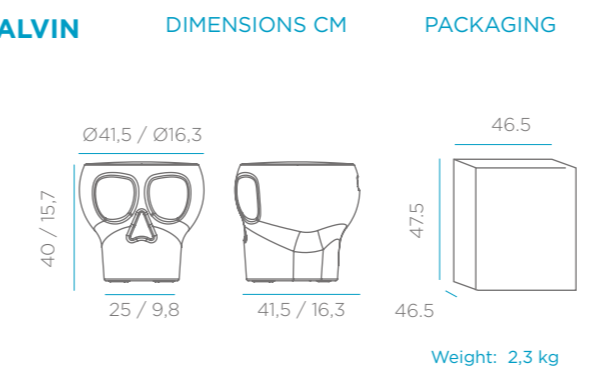

**Options**

- Smarttech (solar + rechargeable battery) \_\_\_\_\_ MOB50V040SSNW
- White color \_\_\_\_\_ MOB50V040BXNW
- Bronze color \_\_\_\_\_ MOB50V040ZXNW
- Topo color \_\_\_\_\_ MOB50V040KXNW

### REFERENCES

**CORFU 40** DIMENSIONS CM PACKAGING REFERENCES

**Options**

- Smarttech (solar + rechargeable battery) \_\_\_\_\_ MOBCF040SSNW
- White color \_\_\_\_\_ MOBCF040BXNW
- Bronze color \_\_\_\_\_ MOBCF040ZXNW
- Topo color \_\_\_\_\_ MOBCF040KXNW

**SICILIA 75** DIMENSIONS CM PACKAGING REFERENCES

**Options**

- Smarttech (solar + rechargeable battery) \_\_\_\_\_ MOBSC075SSNW
- Outdoor cable / white light \* \_\_\_\_\_ MOBSC075OFNW
- White color \_\_\_\_\_ MOBSC075BXNW

**\*BASE**

Base E27 x 1 \*Supplied

**CORFU 74** DIMENSIONS CM PACKAGING REFERENCES

**Options**

- Smarttech (solar + rechargeable battery) \_\_\_\_\_ MOBCF074SSNW
- White color \_\_\_\_\_ MOBCF074BXNW
- Bronze color \_\_\_\_\_ MOBCF074ZXNW
- Topo color \_\_\_\_\_ MOBCF074KXNW

**SICILIA 120** DIMENSIONS CM PACKAGING REFERENCES

**Options**

- Smarttech (solar + rechargeable battery) \_\_\_\_\_ MOBSC120SSNW
- Outdoor cable / white light \* \_\_\_\_\_ MOBSC120OFNW
- White color \_\_\_\_\_ MOBSC120BXNW

**\*BASE**

Base E27 x 1 \*Supplied

**PUFY** DIMENSIONS CM PACKAGING REFERENCES

**Options**

- White color \_\_\_\_\_ MOBPF045BXNW
- Bronze color \_\_\_\_\_ MOBPF045ZXNW
- Topo color \_\_\_\_\_ MOBPF045KXNW

**IBIZA** DIMENSIONS CM PACKAGING REFERENCES

**Options**

- Smarttech (solar + rechargeable battery) \_\_\_\_\_ MOBBI20SSNW
- Outdoor cable / white light \* \_\_\_\_\_ MOBBI20OFNW
- White color \_\_\_\_\_ MOBBI20BXNW

**\*BASE**

Base E27 x 1 \*Supplied

**TAFY 38** DIMENSIONS CM PACKAGING REFERENCES

**Options**

- White color \_\_\_\_\_ MOBTFO38BXNW
- Black color \_\_\_\_\_ MOBTFO38NXNW
- Bronze color \_\_\_\_\_ MOBTFO38ZXNW
- Topo color \_\_\_\_\_ MOBTFO38KXNW
- Grey color \_\_\_\_\_ MOBTFO38SXNW

**CRETA** DIMENSIONS CM PACKAGING REFERENCES

**Options**

- Smarttech (solar + rechargeable battery) \_\_\_\_\_ MOBRC120SSNW
- Outdoor cable / white light \* \_\_\_\_\_ MOBRC120OFNW
- White color \_\_\_\_\_ MOBRC120BXNW

**CRETA ACCESSORIZE**

101,5

**\*BASE**

Base E27 x 1 \*Supplied

**BAR**

**BRICKY** DIMENSIONS CM PACKAGING REFERENCES

**Options**

- Cable RGBW \_\_\_\_\_ MOBBR45ORGBWNW
- White color \_\_\_\_\_ MOBBR045BXNW
- Soft pink color \_\_\_\_\_ MOBBR045RSNW
- Bronze color \_\_\_\_\_ MOBBR045ZXNW
- Topo color \_\_\_\_\_ MOBBR045KXNW

**PALMA BOTTLE RACK** DIMENSIONS CM PACKAGING REFERENCES

**Options**

- Outdoor cable / white light \* \_\_\_\_\_ LUMPMB70OFNW
- Smarttech (solar + rechargeable battery) \_\_\_\_\_ LUMPMB70SSNW

**\*BASE**

Base E27 x 1 \*Supplied



**WOODY**

DIMENSIONS CM

PACKAGING

REFERENCES

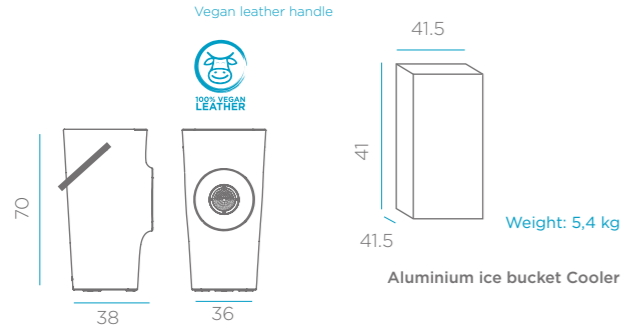
**Options**

- Play light&music \_\_\_\_\_ LUMWD070PLNW
- Smarttech (solar + rechargeable battery) \_\_\_\_\_ LUMWD070SSNW
- Outdoor cable / white light\* \_\_\_\_\_ LUMWD070OFNW

**\*BASE**

Base E27

x 1 **\*Supplied****COOLER**

DIMENSIONS CM

PACKAGING

REFERENCES

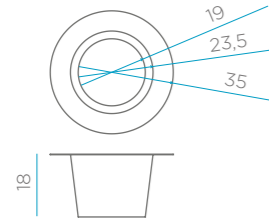
**Options**

- Cooler bambu \_\_\_\_\_ MP00978
- Cooler palma \_\_\_\_\_ MP00979

**FLOWERPOTS****BAMBÚ 70**

DIMENSIONS CM

PACKAGING

REFERENCES

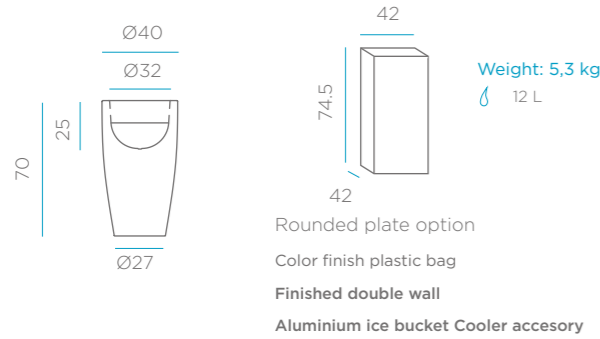
**Options**

- Smarttech (solar + rechargeable battery) \_\_\_\_\_ LUMB070SSNW
- Outdoor cable / white light\* \_\_\_\_\_ LUMB070OFNW
- White color \_\_\_\_\_ JDNBM070BXNW
- Black color \_\_\_\_\_ JDNBM070NXNW
- Bronze color \_\_\_\_\_ JDNBM070ZXNW
- Topo color \_\_\_\_\_ JDNBM070KXNW
- Grey color \_\_\_\_\_ JDNBM070SXNW
- Terracota color \_\_\_\_\_ JDNBM070TXNW
- Soft pink color \_\_\_\_\_ JDNBM070RXNW
- Soft blue color \_\_\_\_\_ JDNBM070AXNW
- Soft green color \_\_\_\_\_ JDNBM070VXNW

**\*BASE**

Base E27

x 1 **\*Supplied****BAMBÚ 90**

DIMENSIONS CM

PACKAGING

REFERENCES

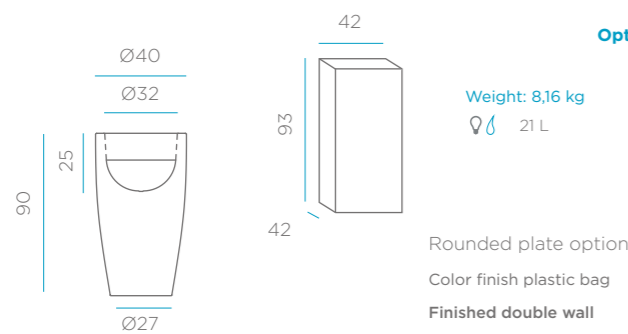
**Options**

- Smarttech (solar + rechargeable battery) \_\_\_\_\_ LUMB090SSNW
- Outdoor cable / white light\* \_\_\_\_\_ LUMB090OFNW
- White color \_\_\_\_\_ JDNBM090BXNW
- Black color \_\_\_\_\_ JDNBM090NXNW
- Bronze color \_\_\_\_\_ JDNBM090ZXNW
- Topo color \_\_\_\_\_ JDNBM090KXNW
- Grey color \_\_\_\_\_ JDNBM090SXNW

**\*BASE**

Base E27

x 1 **\*Supplied****CAMELIA 40**

DIMENSIONS CM

PACKAGING

REFERENCES

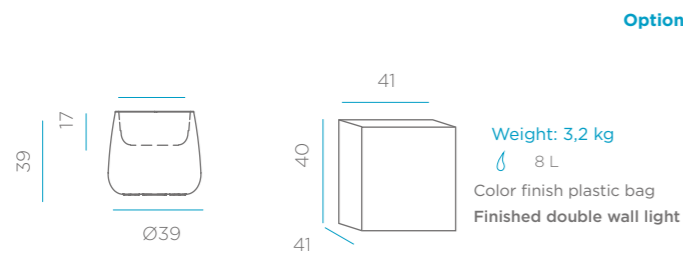
**Options**

- Smarttech (solar + rechargeable battery) \_\_\_\_\_ LUMCA040SSNW
- Outdoor cable / white light\* \_\_\_\_\_ LUMCA040OFNW
- White color \_\_\_\_\_ LUMCA040BXNW
- Black color \_\_\_\_\_ LUMCA040NXNW
- Bronze color \_\_\_\_\_ LUMCA040ZXNW
- Topo color \_\_\_\_\_ LUMCA040KXNW
- Grey color \_\_\_\_\_ LUMCA040SXNW
- Terracota color \_\_\_\_\_ LUMCA040TXNW
- Soft pink color \_\_\_\_\_ LUMCA040RXNW
- Soft blue color \_\_\_\_\_ LUMCA040AXNW
- Soft green color \_\_\_\_\_ LUMCA040VXNW

**\*BASE**

Base E27

x 1 **\*Supplied****CAMELIA 60**

DIMENSIONS CM

PACKAGING

REFERENCES

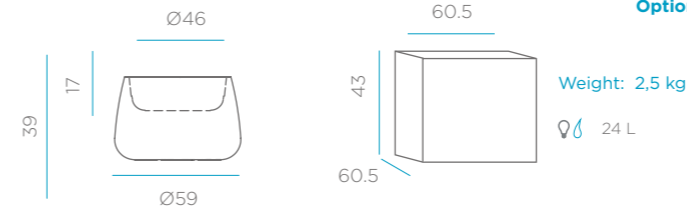
**Options**

- Smarttech (solar + rechargeable battery) \_\_\_\_\_ LUMCA060SSNW
- Outdoor cable / white light\* \_\_\_\_\_ LUMCA060OFNW
- White color \_\_\_\_\_ JDNCA060BXNW
- Black color \_\_\_\_\_ JDNCA060NXNW
- Bronze color \_\_\_\_\_ JDNCA060ZXNW
- Topo color \_\_\_\_\_ JDNCA060KXNW
- Grey color \_\_\_\_\_ JDNCA060SXNW

**\*BASE**

Base E27

x 1 **\*Supplied****CAMELIA 80**

DIMENSIONS CM

PACKAGING

REFERENCES

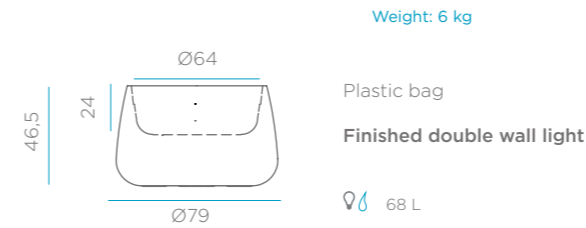
**Options**

- Smarttech (solar + rechargeable battery) \_\_\_\_\_ LUMCA080SSNW
- Outdoor cable / white light\* \_\_\_\_\_ LUMCA080OFNW
- White color \_\_\_\_\_ JDNCA080BXNW
- Black color \_\_\_\_\_ JDNCA080NXNW
- Bronze color \_\_\_\_\_ JDNCA080ZXNW
- Topo color \_\_\_\_\_ JDNCA080KXNW
- Grey color \_\_\_\_\_ JDNCA080SXNW

**\*BASE**

Base E27

x 1 **\*Supplied****CAMELIA LARGE**

DIMENSIONS CM

PACKAGING

REFERENCES

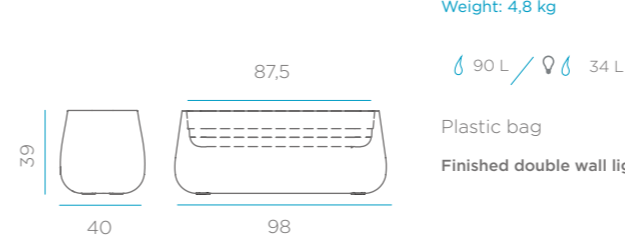
**Options**

- Smarttech (solar + rechargeable battery) \_\_\_\_\_ LUMCALARSSNW
- Outdoor cable / white light\* \_\_\_\_\_ LUMCALAROFNW
- White color \_\_\_\_\_ JDNCA080BXNW
- Black color \_\_\_\_\_ JDNCA080NXNW
- Bronze color \_\_\_\_\_ JDNCA080ZXNW
- Topo color \_\_\_\_\_ JDNCA080KXNW
- Grey color \_\_\_\_\_ JDNCA080SXNW
- Terracota color \_\_\_\_\_ JDNCA080TXNW

**\*BASE**

Base E27

x 1 **\*Supplied****CAMELIA HIGH**

DIMENSIONS CM

PACKAGING

REFERENCES

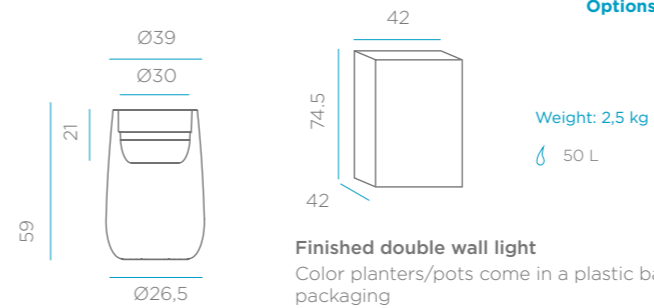
**Options**

- Smarttech (solar + rechargeable battery) \_\_\_\_\_ LUMCAHIGSSNW
- Outdoor cable / white light\* \_\_\_\_\_ LUMCAHIGOFNW
- White color \_\_\_\_\_ JDNCAHIGBXNW
- Black color \_\_\_\_\_ JDNCAHIGNXNW
- Bronze color \_\_\_\_\_ JDNCAHIGZXNW
- Topo color \_\_\_\_\_ JDNCAHIGKXNW
- Grey color \_\_\_\_\_ JDNCAHIGSXNW
- Terracota color \_\_\_\_\_ JDNCAHIGTXNW
- Soft pink color \_\_\_\_\_ JDNCAHIGRXNW
- Soft blue color \_\_\_\_\_ JDNCAHIGAXNW
- Soft green color \_\_\_\_\_ JDNCAHIGVXNW

**\*BASE**

Base E27

x 1 **\*Supplied****FICUS 60**

DIMENSIONS CM

PACKAGING

REFERENCES

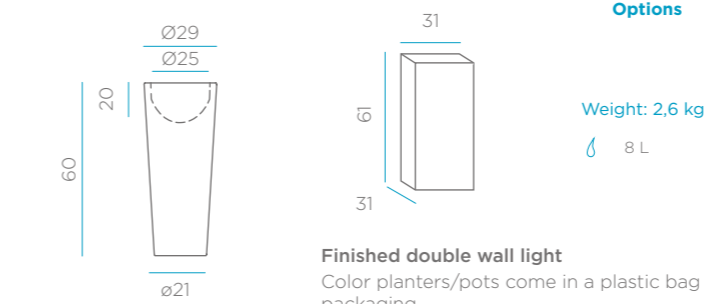
**Options**

- Smarttech (solar + rechargeable battery) \_\_\_\_\_ LUMFC060SSNW
- Outdoor cable / white light\* \_\_\_\_\_ LUMFC060OFNW
- White color \_\_\_\_\_ LUMFC060BXNW
- Black color \_\_\_\_\_ LUMFC060NXNW
- Bronze color \_\_\_\_\_ LUMFC060ZXNW
- Topo color \_\_\_\_\_ LUMFC060KXNW
- Grey color \_\_\_\_\_ LUMFC060SXNW
- Terracota color \_\_\_\_\_ LUMFC060TXNW
- Soft pink color \_\_\_\_\_ LUMFC060RXNW
- Soft blue color \_\_\_\_\_ LUMFC060AXNW
- Soft green color \_\_\_\_\_ LUMFC060VXNW

**\*BASE**

Base E27

x 1 **\*Supplied**

**FICUS 80** DIMENSIONS CM PACKAGING REFERENCES

Weight: 3,2 kg  
8 L

**Options**

- Smarttech (solar + rechargeable battery) \_\_\_\_\_ LUMFC080SSNW
- Outdoor cable / white light\* \_\_\_\_\_ LUMFC080OFNW
- White color \_\_\_\_\_ LUMFC080BXNW ○
- Black color \_\_\_\_\_ LUMFC080NXNW ●
- Bronze color \_\_\_\_\_ LUMFC080ZXNW ●
- Topo color \_\_\_\_\_ LUMFC080KXNW ●
- Grey color \_\_\_\_\_ LUMFC080SXNW ●
- Terracota color \_\_\_\_\_ LUMFC080TXNW ●
- Soft pink color \_\_\_\_\_ LUMFC080RXNW ●
- Soft blue color \_\_\_\_\_ LUMFC080AXNW ●
- Soft green color \_\_\_\_\_ LUMFC080VXNW ●

**\*BASE**

Base E27 x 1 \*Supplied

**Finished double wall light**  
Color planters/pots come in a plastic bag packaging

**JARA 100X35** DIMENSIONS CM PACKAGING REFERENCES

Peso: 6 kg  
45 L

Plastic bag  
Finished double wall

**Options**

- White color \_\_\_\_\_ JDNJR100BXNW ○
- Black color \_\_\_\_\_ JDNJR100NXNW ●
- Bronze color \_\_\_\_\_ JDNJR100ZXNW ●
- Topo color \_\_\_\_\_ JDNJR100KXNW ●
- Grey color \_\_\_\_\_ JDNJR100SXNW ●

**GERBERA 33** DIMENSIONS CM PACKAGING REFERENCES

Weight: 4 kg  
80 L

Plastic bag  
Rounded plate option

**Options**

- White color \_\_\_\_\_ JDNGB033BXNW ○
- Black color \_\_\_\_\_ JDNGB033NXNW ●
- Bronze color \_\_\_\_\_ JDNGB033ZXNW ●
- Topo color \_\_\_\_\_ JDNGB033KXNW ●
- Grey color \_\_\_\_\_ JDNGB033SXNW ●
- Terracota color \_\_\_\_\_ JDNGB033TXNW ●
- Soft pink color \_\_\_\_\_ JDNGB033RXNW ●
- Soft blue color \_\_\_\_\_ JDNGB033AXNW ●
- Soft green color \_\_\_\_\_ JDNGB033VXNW ●

**JARA 100X40** DIMENSIONS CM PACKAGING REFERENCES

Weight: 8 kg  
46 L

Plastic bag  
Finished double wall

**Options**

- White color \_\_\_\_\_ JDNJR140BXNW ○
- Black color \_\_\_\_\_ JDNJR140NXNW ●
- Bronze color \_\_\_\_\_ JDNJR140ZXNW ●
- Topo color \_\_\_\_\_ JDNJR140KXNW ●
- Grey color \_\_\_\_\_ JDNJR140SXNW ●

**GERBERA 45** DIMENSIONS CM PACKAGING REFERENCES

Plastic bag  
Weight: 2 kg  
60 L

Finished double wall  
Rounded plate option  
Color finish plastic bag

**Options**

- White color \_\_\_\_\_ JDNGB045BXNW ○
- Black color \_\_\_\_\_ JDNGB045NXNW ●
- Bronze color \_\_\_\_\_ JDNGB045ZXNW ●
- Topo color \_\_\_\_\_ JDNGB045KXNW ●
- Grey color \_\_\_\_\_ JDNGB045SXNW ●
- Terracota color \_\_\_\_\_ JDNGB045TXNW ●
- Soft pink color \_\_\_\_\_ JDNGB045RXNW ●
- Soft blue color \_\_\_\_\_ JDNGB045AXNW ●
- Soft green color \_\_\_\_\_ JDNGB045VXNW ●

**JUNCO 80** DIMENSIONS CM PACKAGING REFERENCES

Weight: 11,75 kg  
35 L

Color finish plastic bag  
Finished double wall

**Options**

- Smarttech (solar + rechargeable battery) \_\_\_\_\_ LUMJN080SSNW
- Outdoor cable / white light\* \_\_\_\_\_ LUMJN080OFNW
- White color \_\_\_\_\_ JDNJN080BXNW ○
- Black color \_\_\_\_\_ JDNJN080NXNW ●
- Bronze color \_\_\_\_\_ JDNJN080ZXNW ●
- Topo color \_\_\_\_\_ JDNJN080KXNW ●
- Grey color \_\_\_\_\_ JDNJN080SXNW ●

**\*BASE**

Base E27 x 1 \*Supplied

**GERBERA 50** DIMENSIONS CM PACKAGING REFERENCES

Weight: 4 kg  
80 L

Plastic bag  
Rounded plate option

**Options**

- White color \_\_\_\_\_ JDNGB050BXNW ○
- Black color \_\_\_\_\_ JDNGB050NXNW ●
- Bronze color \_\_\_\_\_ JDNGB050ZXNW ●
- Topo color \_\_\_\_\_ JDNGB050KXNW ●
- Grey color \_\_\_\_\_ JDNGB050SXNW ●

**MAGNOLIA 30** DIMENSIONS CM PACKAGING REFERENCES

Weight: 0,9 kg  
11 L / 5 L

Color finish plastic bag  
Finished double wall light

**Options**

- Smarttech (solar + rechargeable battery) \_\_\_\_\_ LUMMG030SSNW
- Outdoor cable / white light\* \_\_\_\_\_ LUMMG030OFNW
- White color \_\_\_\_\_ JDNMG030BXNW ○
- Black color \_\_\_\_\_ JDNMG030NXNW ●
- Bronze color \_\_\_\_\_ JDNMG030ZXNW ●
- Topo color \_\_\_\_\_ JDNMG030KXNW ●
- Grey color \_\_\_\_\_ JDNMG030SXNW ●
- Terracota color \_\_\_\_\_ JDNMG030TXNW ●
- Soft pink color \_\_\_\_\_ JDNMG030RXNW ●
- Soft blue color \_\_\_\_\_ JDNMG030AXNW ●
- Soft green color \_\_\_\_\_ JDNMG030VXNW ●

**\*BASE**

Base E27 x 1 \*Supplied

**HIEDRA** DIMENSIONS CM PACKAGING REFERENCES

Weight: 7 kg  
2,2 L X 2  
1,5 L X 2

Finished double wall  
Color finish plastic bag

**Options**

- Outdoor cable / white light\* \_\_\_\_\_ LUMNC050OFNW
- White color \_\_\_\_\_ JDNNC050BXNW ○
- Black color \_\_\_\_\_ JDNNC050NXNW ●
- Bronze color \_\_\_\_\_ JDNNC050ZXNW ●
- Topo color \_\_\_\_\_ JDNNC050KXNW ●
- Grey color \_\_\_\_\_ JDNNC050SXNW ●

**\*BASE**

Base E27 x 1 \*Supplied

**MAGNOLIA 45** DIMENSIONS CM PACKAGING REFERENCES

Weight: 4,5 kg  
31 L / 16 L

Color finish plastic bag  
Finished double wall light

**Options**

- Smarttech (solar + rechargeable battery) \_\_\_\_\_ LUMMG045SSNW
- Outdoor cable / white light\* \_\_\_\_\_ LUMMG045OFNW
- White color \_\_\_\_\_ JDNMG045BXNW ○
- Black color \_\_\_\_\_ JDNMG045NXNW ●
- Bronze color \_\_\_\_\_ JDNMG045ZXNW ●
- Topo color \_\_\_\_\_ JDNMG045KXNW ●
- Grey color \_\_\_\_\_ JDNMG045SXNW ●
- Terracota color \_\_\_\_\_ JDNMG045TXNW ●
- Soft pink color \_\_\_\_\_ JDNMG045RXNW ●
- Soft blue color \_\_\_\_\_ JDNMG045AXNW ●
- Soft green color \_\_\_\_\_ JDNMG045VXNW ●

**\*BASE**

Base E27 x 1 \*Supplied

**MAGNOLIA 60** DIMENSIONS CM PACKAGING

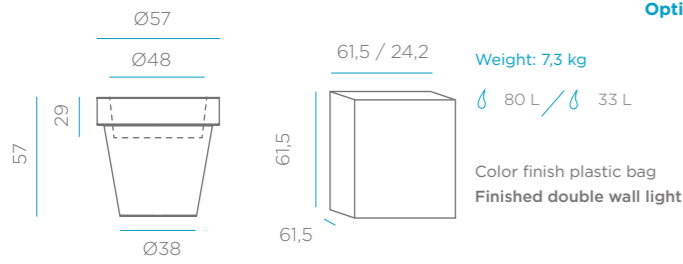

Weight: 7,3 kg  
 80 L / 33 L  
 Color finish plastic bag  
 Finished double wall light

- Options**
- Smarttech (solar + rechargeable battery) \_\_\_\_\_ LUMMG090SSNW
  - Outdoor cable / white light\* \_\_\_\_\_ LUMMG090OFNW
  - White color \_\_\_\_\_ JDNMG090BXNW
  - Black color \_\_\_\_\_ JDNMG090NXNW
  - Bronze color \_\_\_\_\_ JDNMG090ZXNW
  - Topo color \_\_\_\_\_ JDNMG090KXNW
  - Grey color \_\_\_\_\_ JDNMG090SXNW
  - Terracota color \_\_\_\_\_ JDNMG090TXNW

**\*BASE**  
 Base E27 x 1 \*Supplied

REFERENCES

**MELISA 50** DIMENSIONS CM PACKAGING

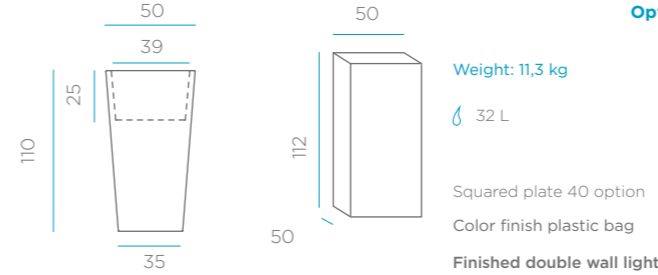

Weight: 11,3 kg  
 32 L  
 Squared plate 40 option  
 Color finish plastic bag  
 Finished double wall light

- Options**
- Smarttech (solar + rechargeable battery) \_\_\_\_\_ LUMML050SSNW
  - Outdoor cable / white light\* \_\_\_\_\_ LUMML050OFNW
  - White color \_\_\_\_\_ JDNML050BXNW
  - Black color \_\_\_\_\_ JDNML050NXNW
  - Bronze color \_\_\_\_\_ JDNML050ZXNW
  - Topo color \_\_\_\_\_ JDNML050KXNW
  - Grey color \_\_\_\_\_ JDNML050SXNW

**\*BASE**  
 Base E27 x 1 \*Supplied

REFERENCES

**MAGNOLIA 90** DIMENSIONS CM PACKAGING

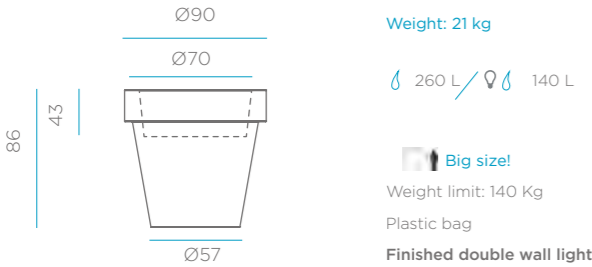

Weight: 21 kg  
 260 L / 140 L  
 Big size!  
 Weight limit: 140 Kg  
 Plastic bag  
 Finished double wall light

- Options**
- Smarttech (solar + rechargeable battery) \_\_\_\_\_ LUMMG090SSNW
  - Outdoor cable / white light\* \_\_\_\_\_ LUMMG090OFNW
  - White color \_\_\_\_\_ JDNMG090BXNW
  - Black color \_\_\_\_\_ JDNMG090NXNW
  - Bronze color \_\_\_\_\_ JDNMG090ZXNW
  - Topo color \_\_\_\_\_ JDNMG090KXNW
  - Grey color \_\_\_\_\_ JDNMG090SXNW
  - Terracota color \_\_\_\_\_ JDNMG090TXNW

**\*BASE**  
 Base E27 x 1 \*Supplied

REFERENCES

**NARCISO 35** DIMENSIONS CM PACKAGING

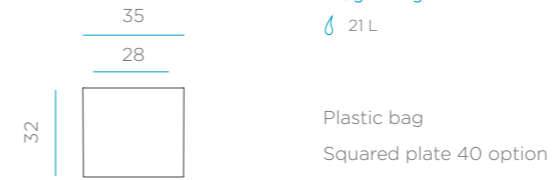

Weight: 2 kg  
 21 L  
 Plastic bag  
 Squared plate 40 option

- Options**
- White color \_\_\_\_\_ JDNNC035BXNW
  - Black color \_\_\_\_\_ JDNNC035NXNW
  - Bronze color \_\_\_\_\_ JDNNC035ZXNW
  - Topo color \_\_\_\_\_ JDNNC035KXNW
  - Grey color \_\_\_\_\_ JDNNC035SXNW
  - Terracota color \_\_\_\_\_ JDNNC035TXNW
  - Soft pink color \_\_\_\_\_ JDNNC035RXNW
  - Soft blue color \_\_\_\_\_ JDNNC035AXNW
  - Soft green color \_\_\_\_\_ JDNNC035VXNW

REFERENCES

**MAGNOLIA 130** DIMENSIONS CM PACKAGING

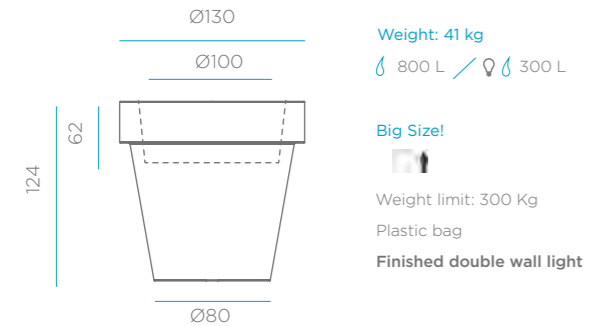

Weight: 41 kg  
 800 L / 300 L  
 Big Size!  
 Weight limit: 300 Kg  
 Plastic bag  
 Finished double wall light

- Options**
- Smarttech (solar + rechargeable battery) \_\_\_\_\_ LUMMG130SSNW
  - Outdoor cable / white light\* \_\_\_\_\_ LUMMG130OFNW
  - White color \_\_\_\_\_ JDNMG130BXNW
  - Black color \_\_\_\_\_ JDNMG130NXNW
  - Bronze color \_\_\_\_\_ JDNMG130ZXNW
  - Topo color \_\_\_\_\_ JDNMG130KXNW
  - Grey color \_\_\_\_\_ JDNMG130SXNW
  - Terracota color \_\_\_\_\_ JDNMG130TXNW

**\*BASE**  
 Base E27 x 1 \*Supplied

REFERENCES

**NARCISO 40** DIMENSIONS CM PACKAGING

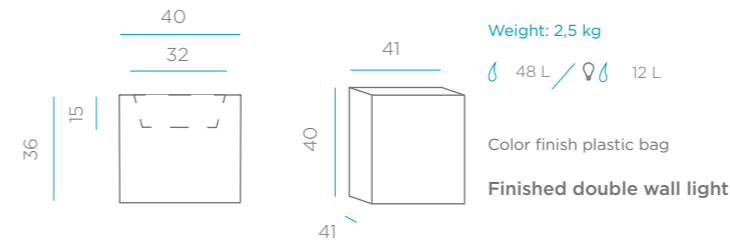

Weight: 2,5 kg  
 48 L / 12 L  
 Color finish plastic bag  
 Finished double wall light

- Options**
- Smarttech (solar + rechargeable battery) \_\_\_\_\_ LUMNC040SSNW
  - Outdoor cable / white light\* \_\_\_\_\_ LUMNC040OFNW
  - White color \_\_\_\_\_ JDNNC040BXNW
  - Black color \_\_\_\_\_ JDNNC040NXNW
  - Bronze color \_\_\_\_\_ JDNNC040ZXNW
  - Topo color \_\_\_\_\_ JDNNC040KXNW
  - Grey color \_\_\_\_\_ JDNNC040SXNW
  - Terracota color \_\_\_\_\_ JDNNC040TXNW
  - Soft pink color \_\_\_\_\_ JDNNC040RXNW
  - Soft blue color \_\_\_\_\_ JDNNC040AXNW
  - Soft green color \_\_\_\_\_ JDNNC040VXNW

**\*BASE**  
 Base E27 x 1 \*Supplied

REFERENCES

**MELISA 30** DIMENSIONS CM PACKAGING

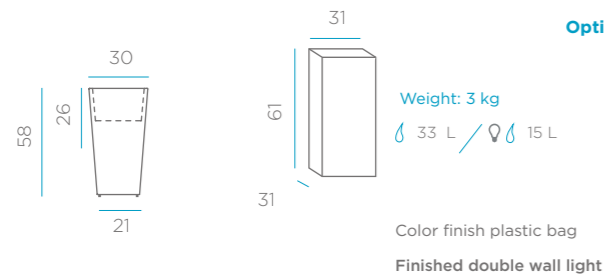

Weight: 3 kg  
 33 L / 15 L  
 Color finish plastic bag  
 Finished double wall light

- Options**
- Smarttech (solar + rechargeable battery) \_\_\_\_\_ LUMML030SSNW
  - Outdoor cable / white light\* \_\_\_\_\_ LUMML030OFNW
  - White color \_\_\_\_\_ JDNML030BXNW
  - Black color \_\_\_\_\_ JDNML030NXNW
  - Bronze color \_\_\_\_\_ JDNML030ZXNW
  - Topo color \_\_\_\_\_ JDNML030KXNW
  - Grey color \_\_\_\_\_ JDNML030SXNW

**\*BASE**  
 Base E27 x 1 \*Supplied

REFERENCES

**NARCISO 50** DIMENSIONS CM PACKAGING

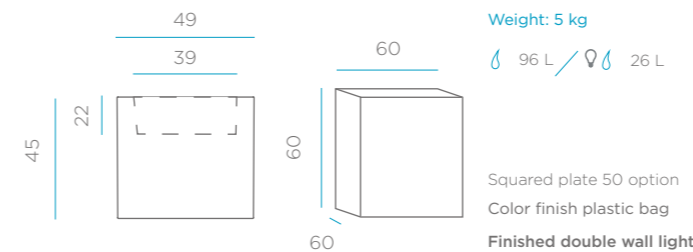

Weight: 5 kg  
 96 L / 26 L  
 Squared plate 50 option  
 Color finish plastic bag  
 Finished double wall light

- Options**
- Smarttech (solar + rechargeable battery) \_\_\_\_\_ LUMNC050SSNW
  - Outdoor cable / white light\* \_\_\_\_\_ LUMNC050OFNW
  - White color \_\_\_\_\_ JDNNC050BXNW
  - Black color \_\_\_\_\_ JDNNC050NXNW
  - Bronze color \_\_\_\_\_ JDNNC050ZXNW
  - Topo color \_\_\_\_\_ JDNNC050KXNW
  - Grey color \_\_\_\_\_ JDNNC050SXNW
  - Terracota color \_\_\_\_\_ JDNNC050TXNW

**\*BASE**  
 Base E27 x 1 \*Supplied

REFERENCES

**MELISA 40** DIMENSIONS CM PACKAGING

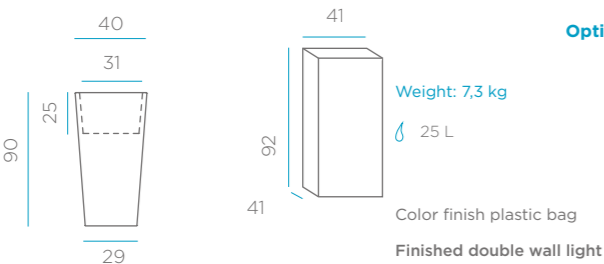

Weight: 7,3 kg  
 25 L  
 Color finish plastic bag  
 Finished double wall light

- Options**
- Smarttech (solar + rechargeable battery) \_\_\_\_\_ LUMML040SSNW
  - Outdoor cable / white light\* \_\_\_\_\_ LUMML040OFNW
  - White color \_\_\_\_\_ JDNML040BXNW
  - Black color \_\_\_\_\_ JDNML040NXNW
  - Bronze color \_\_\_\_\_ JDNML040ZXNW
  - Topo color \_\_\_\_\_ JDNML040KXNW
  - Grey color \_\_\_\_\_ JDNML040SXNW

**\*BASE**  
 Base E27 x 1 \*Supplied

REFERENCES

**NARCISO 60** DIMENSIONS CM PACKAGING



Weight: 7 kg  
 96 L  
 Plastic bag

- Options**
- White color \_\_\_\_\_ JDNNC060BXNW
  - Black color \_\_\_\_\_ JDNNC060NXNW
  - Bronze color \_\_\_\_\_ JDNNC060ZXNW
  - Topo color \_\_\_\_\_ JDNNC060KXNW
  - Grey color \_\_\_\_\_ JDNNC060SXNW

REFERENCES

**PALMA 70** DIMENSIONS CM PACKAGING REFERENCES

**Options**

- Smarttech (solar + rechargeable battery) \_\_\_\_\_ LUMPM070SSNW
- Outdoor cable / white light\* \_\_\_\_\_ LUMPM070OFNW
- White color \_\_\_\_\_ JDNPM070BXNW
- Black color \_\_\_\_\_ JDNPM070NXNW
- Bronze color \_\_\_\_\_ JDNPM070ZXNW
- Topo color \_\_\_\_\_ JDNPM070KXNW

**\*BASE**

Base E27 x 1 \*Supplied

**PALMERA** DIMENSIONS CM PACKAGING REFERENCES

**Options**

- Smarttech (solar + rechargeable battery) \_\_\_\_\_ LUMPA080SSNW
- Outdoor cable / white light\* \_\_\_\_\_ LUMPA080OFNW
- White color \_\_\_\_\_ JDNPA080BXNW
- Black color \_\_\_\_\_ JDNPA080NXNW
- Bronze color \_\_\_\_\_ JDNPA080ZXNW
- Topo color \_\_\_\_\_ JDNPA080KXNW
- Grey color \_\_\_\_\_ JDNPA080SXNW

**\*BASE**

Base E27 x 1 \*Supplied

**VIOLETA 30** DIMENSIONS CM PACKAGING REFERENCES

**Options**

- White color \_\_\_\_\_ JDNVL030BXNW
- Black color \_\_\_\_\_ JDNVL030NXNW
- Bronze color \_\_\_\_\_ JDNVL030ZXNW
- Topo color \_\_\_\_\_ JDNVL030KXNW
- Grey color \_\_\_\_\_ JDNVL030SXNW
- Terracota color \_\_\_\_\_ JDNVL030TXNW
- Soft pink color \_\_\_\_\_ JDNVL030RXNW
- Soft blue color \_\_\_\_\_ JDNVL030AXNW
- Soft green color \_\_\_\_\_ JDNVL030VXNW

**VIOLETA 40** DIMENSIONS CM PACKAGING REFERENCES

**Options**

- Smarttech (solar + rechargeable battery) \_\_\_\_\_ LUMVL040SSNW
- Outdoor cable / white light\* \_\_\_\_\_ LUMVL040OFNW
- White color \_\_\_\_\_ JDNVL040BXNW
- Black color \_\_\_\_\_ JDNVL040NXNW
- Bronze color \_\_\_\_\_ JDNVL040ZXNW
- Topo color \_\_\_\_\_ JDNVL040KXNW
- Grey color \_\_\_\_\_ JDNVL040SXNW
- Soft pink color \_\_\_\_\_ JDNVL040RXNW
- Soft blue color \_\_\_\_\_ JDNVL040AXNW
- Soft green color \_\_\_\_\_ JDNVL040VXNW

**\*BASE**

Base E27 x 1 \*Supplied

**VIOLETA 55** DIMENSIONS CM PACKAGING REFERENCES

**Options**

- Smarttech (solar + rechargeable battery) \_\_\_\_\_ LUMVL055SSNW
- Outdoor cable / white light\* \_\_\_\_\_ LUMVL055OFNW
- White color \_\_\_\_\_ JDNVL055BXNW
- Black color \_\_\_\_\_ JDNVL055NXNW
- Bronze color \_\_\_\_\_ JDNVL055ZXNW
- Topo color \_\_\_\_\_ JDNVL055KXNW
- Grey color \_\_\_\_\_ JDNVL055SXNW
- Terracota color \_\_\_\_\_ JDNVL055TXNW

**\*BASE**

Base E27 x 1 \*Supplied

## 8- PLACE A BULB / TUBE

### PLACE A BULB lamp holder E27

All our products include a base screwed cap to change a bulb.

\* Check product model



Some Newgarden products use lamp holders G13 (led tube)

## 9- PLAY LIGHT&MUSIC (USE MODE)

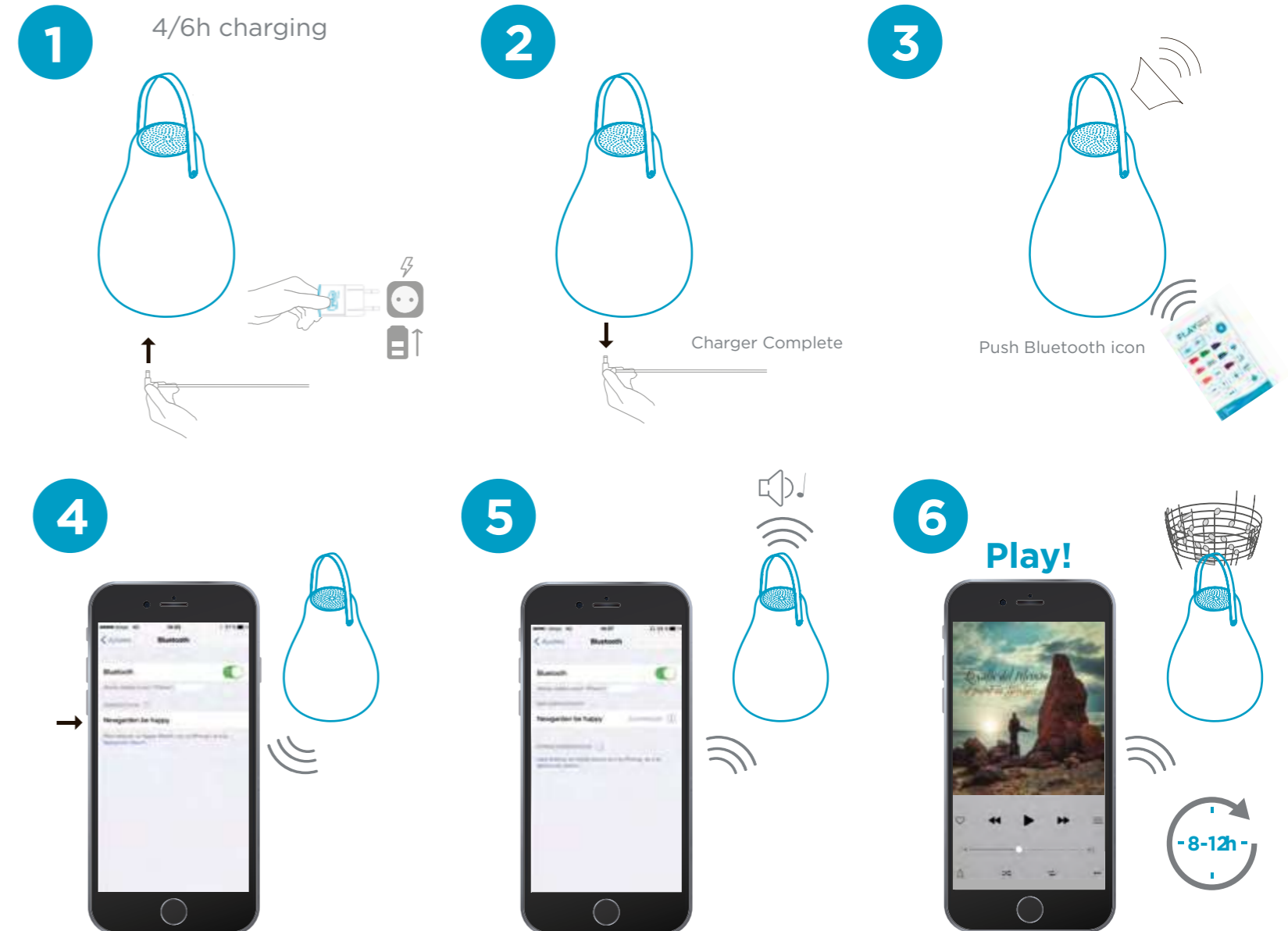

\*Characteristics may vary depending on future updates or product improvements

## 10- BAR FIXATION KIT

Combine two articles: Ibiza/Sicilia/Creta bar.

Place the fixation plate to the desired length and mark the drilling holes ends.

Screw fixation plate.

Attach the plastic applique with screws included.

x2  \*Fixation kit not included with the product  
x4 

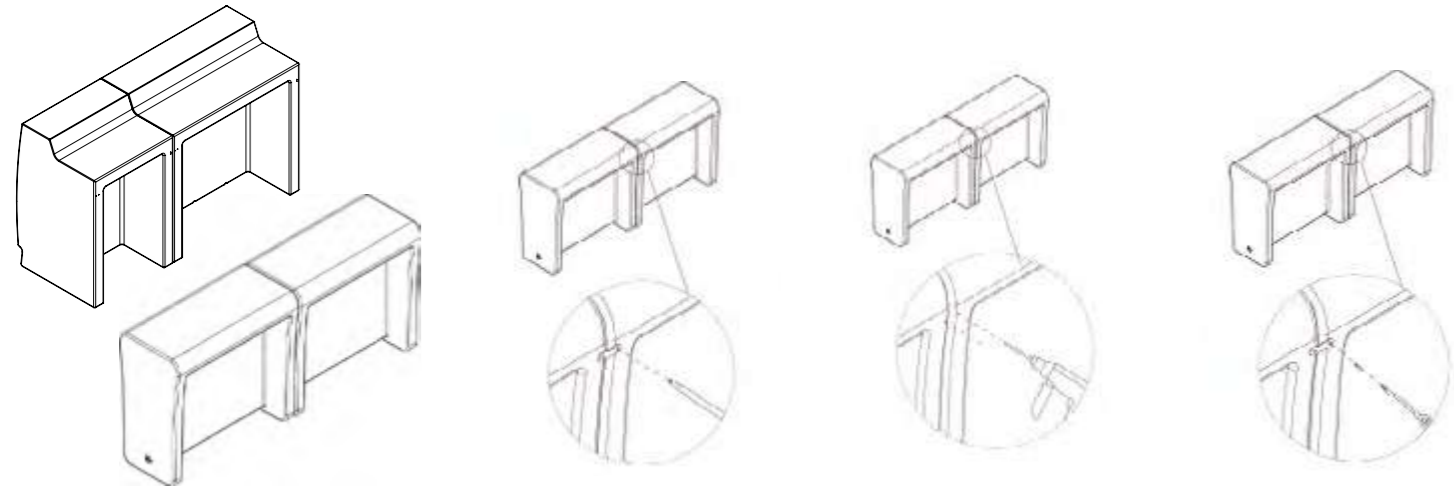

Union of various

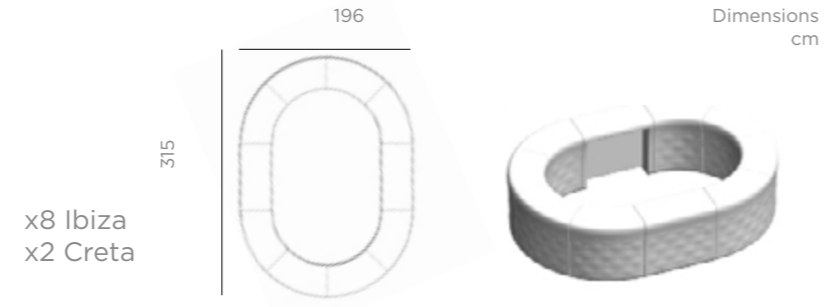

Attachment bar fixation kit includes:

- Screws
- Plastic applique

## 11- FIXATION RECOMMENDATIONS

If you want to fix Newgarden products to the floor:

x4  Supplied  
x8 

Place the product upright.

Drill base product.

Screw the plate on the base.

Attach the plate to the floor.

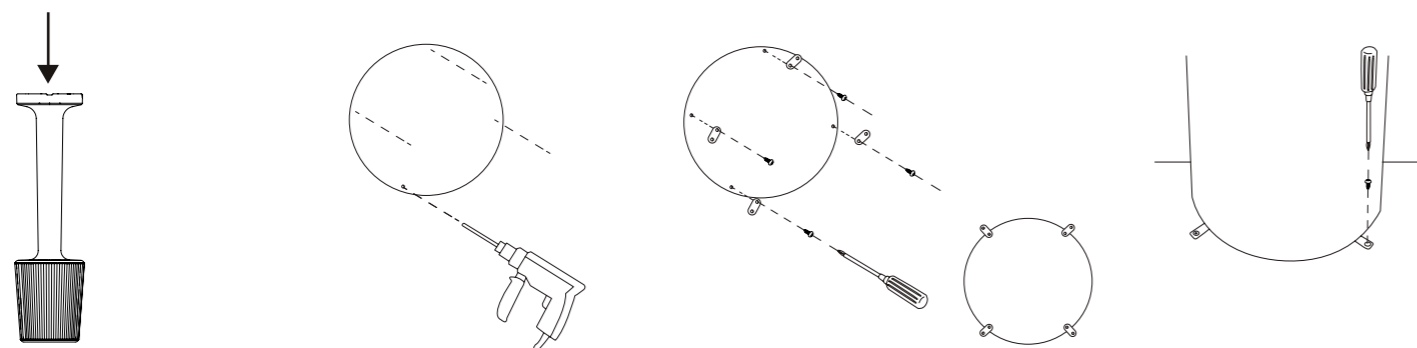

## 12- PLANTING SYSTEM

There are three different types of planting system in pots.

- A. No water reservoir
- B. Water reservoir
- C. Light planters plantation

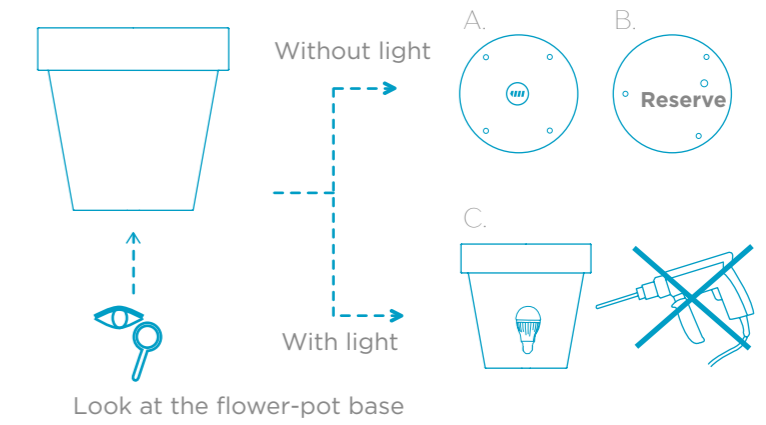

### A. No water reservoir planting // B. Water reservoir planting

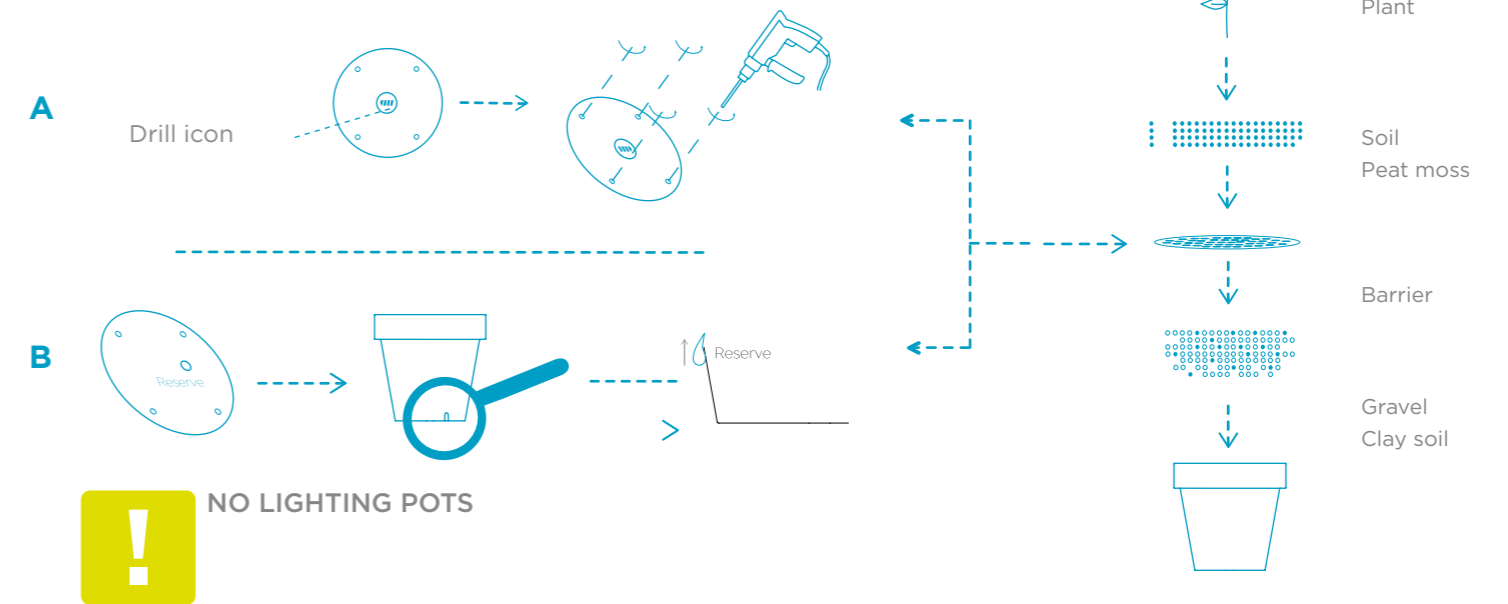

### C. Lighting pots planting

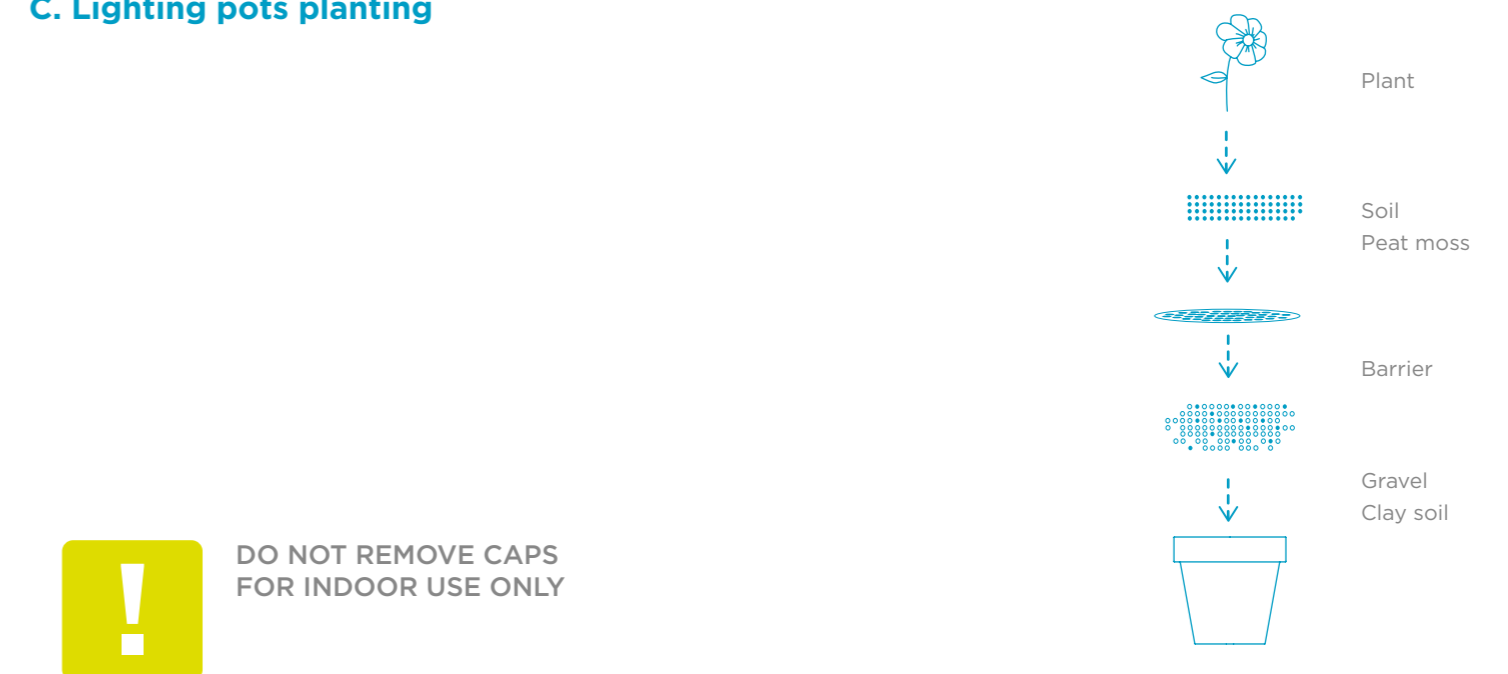

\*Our planting instructions have been designed to respect product's capacity and security measures. Any planting system that does not comply with usage guidelines may affect the product status and no claims will be accepted



